

MICROSCAN®

MicroHAWK ID-20 / ID-30 / ID-40 User Manual



Copyright and Disclaimer

Copyright ©2017
Microscan Systems, Inc.
Tel: +1.425.226.5700 / 800.762.1149
Fax: +1.425.226.8250

All rights reserved. The information contained herein is proprietary and is provided solely for the purpose of allowing customers to operate and/or service Microscan manufactured equipment and is not to be released, reproduced, or used for any other purpose without written permission of Microscan.

Throughout this manual, trademarked names might be used. We state herein that we are using the names to the benefit of the trademark owner, with no intention of infringement.

Disclaimer

The information and specifications described in this manual are subject to change without notice.

Latest Manual Version

For the latest version of this manual, see the Download Center on our web site at: www.microscan.com.

Technical Support

For technical support, e-mail: helpdesk@microscan.com.

Warranty

For current warranty information, see: www.microscan.com/warranty.

Microscan Systems, Inc.

United States Corporate Headquarters
+1.425.226.5700 / 800.762.1149

United States Northeast Technology Center
+1.603.598.8400 / 800.468.9503

European Headquarters
+31.172.423360

Asia Pacific Headquarters
+65.6846.1214

Table of Contents

Chapter 1	Quick Start	
	MicroHAWK ID and WebLink Quick Start.....	1-2
	Step 1 Check Hardware and Connect the System.....	1-2
	Step 2 Mount and Position the Reader.....	1-3
	Step 3 Install WebLink Drivers (ID-20 and ID-30).....	1-4
	Step 4 Connect to WebLink.....	1-5
	Step 5 Explore the Start View.....	1-6
	Step 6 Create a New Setup or Load an Existing Setup.....	1-7
	Step 7 Explore the Setup View.....	1-8
	Step 8 Configure Read Cycle Settings.....	1-9
	Step 9 Configure Acquire Settings.....	1-11
	Step 10 Configure Symbology Settings.....	1-14
	Step 11 Format Output and Configure Match String.....	1-15
	Step 12 Configure Output 1, 2, and 3 Settings.....	1-16
	Step 13 Run the Application.....	1-17
	MicroHAWK ID and ESP Software Quick Start.....	1-18
	Step 1 Check Hardware and Connect the System.....	1-18
	Step 2 Mount and Position the Reader.....	1-19
	Step 3 Install ESP.....	1-20
	Step 4 Select Model.....	1-21
	Step 5 Connect.....	1-22
	Step 6 Locate the Symbol in the Field of View.....	1-23
	Step 7 Calibrate.....	1-24
	Step 8 Test Read Rate.....	1-25
	Step 9 Configure the Reader in ESP.....	1-26
	Step 10 Save Configuration in ESP.....	1-27
	MicroHAWK ID Part Numbers.....	1-28
Chapter 2	Using ESP	
	EZ Mode.....	2-2
	Application Mode.....	2-3
	Menu Toolbar.....	2-4
	View.....	2-13
	Navigating in ESP.....	2-14
	Send/Receive Options.....	2-15
Chapter 3	Communications	
	Communications by ESP.....	3-2
	Communications Serial Commands.....	3-3
	Host Port Connections.....	3-4
	Host Port Protocol.....	3-5
	ACK/NAK Options.....	3-6
	Polling Mode Options.....	3-7

Table of Contents

Ethernet	3-8
Response Timeout	3-14
LRC (Longitudinal Redundancy Check) Status	3-15
Protocol Configuration Examples	3-16
Preamble	3-17
Postamble	3-18
USB HID/Keyboard	3-19
EtherNet/IP Byte Swapping Enabled	3-24
PROFINET	3-25
USB Mass Storage Driver	3-26
Entering ASCII Characters as Hex Values	3-27
Chapter 4 Calibration	
Calibration Serial Commands	4-2
Calibration Overview	4-2
Calibration Options	4-3
Calibration by ESP	4-10
Initiating Calibration	4-12
Additional Notes about Calibration	4-13
Chapter 5 Read Cycle	
Read Cycle by ESP	5-2
Read Cycle Serial Commands	5-3
Read Cycle Setup	5-4
Multisymbol	5-5
Trigger Mode and Filter Duration	5-6
External Trigger Polarity	5-11
Serial Trigger	5-12
Serial Trigger Start Character (Non-Delimited)	5-13
Serial Trigger Stop Character (Non-Delimited)	5-14
End of Read Cycle	5-15
Capture Mode	5-17
Capture Timing	5-22
Image Processing Timeout	5-24
Image Storage	5-25
Minimum Good Reads	5-27
Chapter 6 Symbologies	
Symbologies by ESP	6-2
Symbologies Serial Commands	6-3
Data Matrix	6-4
Aztec	6-6
QR Code	6-7
Micro QR Code	6-8
Code 39	6-9
Code 128/EAN 128	6-12
BC412	6-15

Interleaved 2 of 5	6-16
Code 93	6-19
Codabar	6-20
UPC/EAN	6-23
Pharmacode	6-27
Postal Symbolologies	6-29
GS1 DataBar	6-34
PDF417	6-36
MicroPDF417	6-37
Composite	6-38
DotCode	6-39
Chapter 7 I/O Parameters	
I/O Parameters by ESP	7-2
I/O Parameters Serial Commands	7-3
Symbol Data Output	7-4
No-Read Message	7-7
Read Duration Output	7-8
Output Indicators	7-9
LED Configuration	7-14
Serial Verification	7-15
Setup Button	7-16
Setup Button Modes	7-18
Configurable Output 1	7-20
Trend Analysis Output 1	7-23
ISO/IEC 16022 Symbol Quality Output 1	7-26
Diagnostic Output 1	7-29
Configurable Output 2	7-30
Trend Analysis Output 2	7-30
ISO/IEC 16022 Symbol Quality Output 2	7-30
Diagnostic Output 2	7-30
Configurable Output 3	7-31
Trend Analysis Output 3	7-31
ISO/IEC 16022 Symbol Quality Output 3	7-31
Diagnostic Output 3	7-31
Power-On/Reset Counts	7-32
Time Since Reset	7-33
Service Message	7-34
Frame Information	7-36
Image Output	7-37
Database Identifier Output	7-40
Quality Output	7-41
EZ Trax Output	7-42
Image Push to Host	7-45
Image Push to Host Detailed Setup	7-47

Table of Contents

Chapter 8	Symbol Quality	
	Symbol Quality by ESP	8-2
	Symbol Quality Serial Commands	8-3
	Overview of Symbol Quality	8-4
	Symbol Quality Separator/Data Matrix Output Mode	8-8
	ISO/IEC 16022 Symbol Quality Output	8-10
	ISO/IEC 16022 Symbol Quality Output by ESP	8-12
	Microscan Symbol Quality Output	8-13
	Microscan Symbol Quality Output by ESP	8-16
Chapter 9	Matchcode	
	Matchcode by ESP	9-2
	Matchcode Serial Commands	9-3
	Overview of Matchcode	9-4
	Matchcode Type	9-5
	Sequence Step Interval	9-10
	Match Replace	9-11
	Mismatch Replace	9-12
	New Master Pin	9-13
Chapter 10	Camera and IP Setup	
	Camera and IP Setup by ESP	10-2
	Camera and IP Setup Serial Commands	10-3
	Video	10-4
	Evaluation	10-5
	Calibration	10-8
	Window of Interest	10-9
	Configuration Database	10-13
	Dynamic Setup	10-14
	Pixel Binning	10-15
	Camera Settings	10-16
	White Balance Settings	10-17
	Color Filter	10-18
	Focus Setup	10-19
	Illumination Brightness	10-21
	Morphological Pre-Processing	10-22
	Morphological Operation and Operator Size	10-23
	Damaged Symbol	10-26
	Linear Security Level	10-27
	Set License	10-28
Chapter 11	Configuration Database	
	Configuration Database Serial Commands	11-2
	Number of Active Indexes	11-3
	Configuration Database Status	11-4
	Database Mode	11-10
	Save Current Settings to Configuration Database	11-15

Load Current Settings from Configuration Database.....	11-16
Request Selected Index Settings	11-17
Request All Configuration Database Settings	11-17
Chapter 12 Terminal	
Terminal.....	12-2
Find.....	12-3
Send	12-4
Macros.....	12-5
Terminal Menus.....	12-6
Chapter 13 Utilities	
Operational Commands.....	13-2
Read Rate	13-4
Counters	13-6
Device Control	13-8
Differences from Default	13-9
Master Database	13-10
Firmware.....	13-16
Default/Reset/Save.....	13-19
Reader Status Requests	13-21
Other Operational Commands.....	13-23
Chapter 14 Output Format	
Output Format Serial Commands.....	14-2
Output Format Status	14-3
Format Assign	14-4
Format Extract.....	14-5
Format Insert	14-7
Output Filter Configuration	14-9
Number of Filters	14-14
Appendices	
Appendix A General Specifications	A-2
Appendix B Electrical Specifications	A-8
Appendix C Serial Commands	A-10
Appendix D Communications Protocol	A-12
Appendix E ASCII Table.....	A-13
Appendix F Glossary of Terms	A-14

About MicroHAWK ID Readers

The key features of the MicroHAWK ID-20, ID-30, and ID-40 Readers are:

- World's smallest industrial barcode readers
- Able to read any symbol on any surface
- Intuitive WebLink user interface
- Customizable hardware options
- Customizable software options

MicroHAWK ID Communications

There are three ways to configure and test the MicroHAWK ID-20, ID-30, and ID-40:

- Microscan's browser-based **WebLink** user interface, which enables you to access, configure, and test your reader without having to install software or access files on a host system;
- Microscan's **ESP Software**, which allows you to configure your reader using simple tree controls and UI elements;
- Serial commands that can be sent from the **Terminal** in WebLink or ESP, or from another terminal program.

About This Manual

The purpose of this user manual is to document the hardware and firmware of the MicroHAWK ID series of readers, as well as the software used to configure and operate those readers. The browser-based WebLink interface is the preferred configuration tool for MicroHAWK ID readers, but ESP Software is useful for certain operations, such as:

- Device discovery to find the reader IP address;
- If you only have an RS-232 (serial) connection;
- Updating MicroHAWK ID firmware;
- Using the Configuration Database;
- Creating barcodes for reader configuration;
- Generating Symbol Quality reports.

Parts of this manual introduce the basic functionality of WebLink, but *WebLink Help* in the WebLink user interface provides more detailed information. This manual's primary focus is MicroHAWK ID firmware and ESP Software.

Statements of Compliance



FCC

The MicroHAWK ID-20, ID-30, and ID-40 have been tested for compliance with FCC (Federal Communications Commission) requirements and has been found to conform to applicable FCC standards.

To comply with FCC RF exposure compliance requirements, this device must not be co-located with or operate in conjunction with any other antenna or transmitter.

Changes or modifications not expressly approved by the party responsible for compliance could void the user's authority to operate the equipment.

CE

The MicroHAWK ID-20, ID-30, and ID-40 have been tested for compliance with EU Directive 2014/30/EU for Electromagnetic Compatibility, and has been found to conform to applicable CE standards, specifically the following requirements:

General Immunity for ITE Equipment: EN 55024:2010

Radiated and Conducted Emissions of ITE Equipment: EN 55022:2010.

The CE Declaration of Conformity for this product is available from Microscan upon request.

The MicroHAWK ID-20, ID-30, and ID-40 have been tested by an independent electromagnetic compatibility laboratory in accordance with the applicable specifications and instructions.

UL

The MicroHAWK ID-20, ID-30, and ID-40 have been tested for compliance with UL (Underwriters Laboratories) standards and guidelines, and has been found to conform to applicable UL standards.

Information Technology Equipment – Safety IEC/EN 60950-1

Photobiological Safety of Lamps and Lamp Systems – IEC/EN 62471

Restricted Substances

See the following link for Microscan compliance statements related to all applicable restricted substances:

<http://www.microscan.com/en-us/AboutUs/quality-environmental-management-system.aspx>

Warning and Caution Summary



The MicroHAWK ID-20 USB connector may be susceptible to an ESD event that could cause loss of functionality. Under normal operating conditions, the user is not likely to touch the USB connector except during installation. Therefore, it is advised that the user connect the USB connector to the MicroHAWK ID-20 before plugging into the host computer. Use proper grounding techniques before handling the device during operation. If an ESD event occurs and operation is interrupted, reset the device by cycling power.

NOTICE: The Light Emitting Diodes used in the MicroHAWK product are classified as exempt. This classification is considered safe and represents no photobiological hazard. As with any light source they should be used consistent with their intended use. Do not stare directly at the LED output.

Location of the MicroHAWK's LED aperture window:



This reader is intended for connection to a UL-listed direct plug-in power unit marked Class II and rated 10 to 28 VDC at 5 watts or greater.

U.S. models must use a similarly-rated Class I or Class II power supply that is certified to comply with standards for safety IEC 60950-1 Ed. 2 (2005) and IEC 60825-1 Ed. 2 (2007).

European models must use a similarly-rated Class I or Class II power supply that is certified to comply with standard for safety EN 60950-1 (2006) with Am. 11 (2009).

There are no user-serviceable parts in the reader. Opening the imager voids the Microscan Systems, Inc. warranty.

1 Quick Start

Contents

MicroHAWK ID and WebLink Quick Start	1-2
Step 1 Check Hardware and Connect the System	1-2
Step 2 Mount and Position the Reader	1-3
Step 3 Install WebLink Drivers (ID-20 and ID-30).....	1-4
Step 4 Connect to WebLink	1-5
Step 5 Explore the Start View	1-6
Step 6 Create a New Setup or Load an Existing Setup	1-7
Step 7 Explore the Setup View	1-8
Step 8 Configure Read Cycle Settings	1-9
Step 9 Configure Acquire Settings.....	1-11
Step 10 Configure Symbology Settings	1-14
Step 11 Format Output and Configure Match String.....	1-15
Step 12 Configure Output 1, 2, and 3 Settings	1-16
Step 13 Run the Application	1-17
MicroHAWK ID and ESP Software Quick Start.....	1-18
Step 1 Check Hardware and Connect the System	1-18
Step 2 Mount and Position the Reader	1-19
Step 3 Install ESP	1-20
Step 4 Select Model.....	1-21
Step 5 Connect	1-22
Step 6 Locate the Symbol in the Field of View	1-23
Step 7 Calibrate	1-24
Step 8 Test Read Rate	1-25
Step 9 Configure the Reader in ESP	1-26
Step 10 Save Configuration in ESP	1-27
MicroHAWK ID Part Numbers.....	1-28

This section is designed to get your MicroHAWK up and running quickly with **WebLink** or **ESP Software**. Following these steps will allow you to get a sense of the reader's capabilities and to test sample symbols.

MicroHAWK ID and WebLink Quick Start

Step 1 — Check Hardware and Connect the System

Item	Description	Part Number
1	MicroHAWK ID-20, MicroHAWK ID-30, or MicroHAWK ID-40	7AXY-YZZZ-LPPP
2	Cable, USB A to Micro B, 6 ft., ID-20	61-9000034-01
3	Cable, USB A to Micro B, 3 ft., ID-20	61-9000045-01
4	Power Supply, 5V	97-9000006-01
5	Cable, DB15 to Ext. Power/USB, ID-30	61-9000038-01
6	Power Supply, 100-240VAC, +24VDC, M12 12-Pin Socket	97-000012-01
7	Cordset, Host, Ethernet, M12 8-Pin Plug (Screw-On) to RJ45, 1 m.	61-000160-03

Note: See the *MicroHAWK ID-20 / ID-30 / ID-40 Configuration Guide* for all configurations.

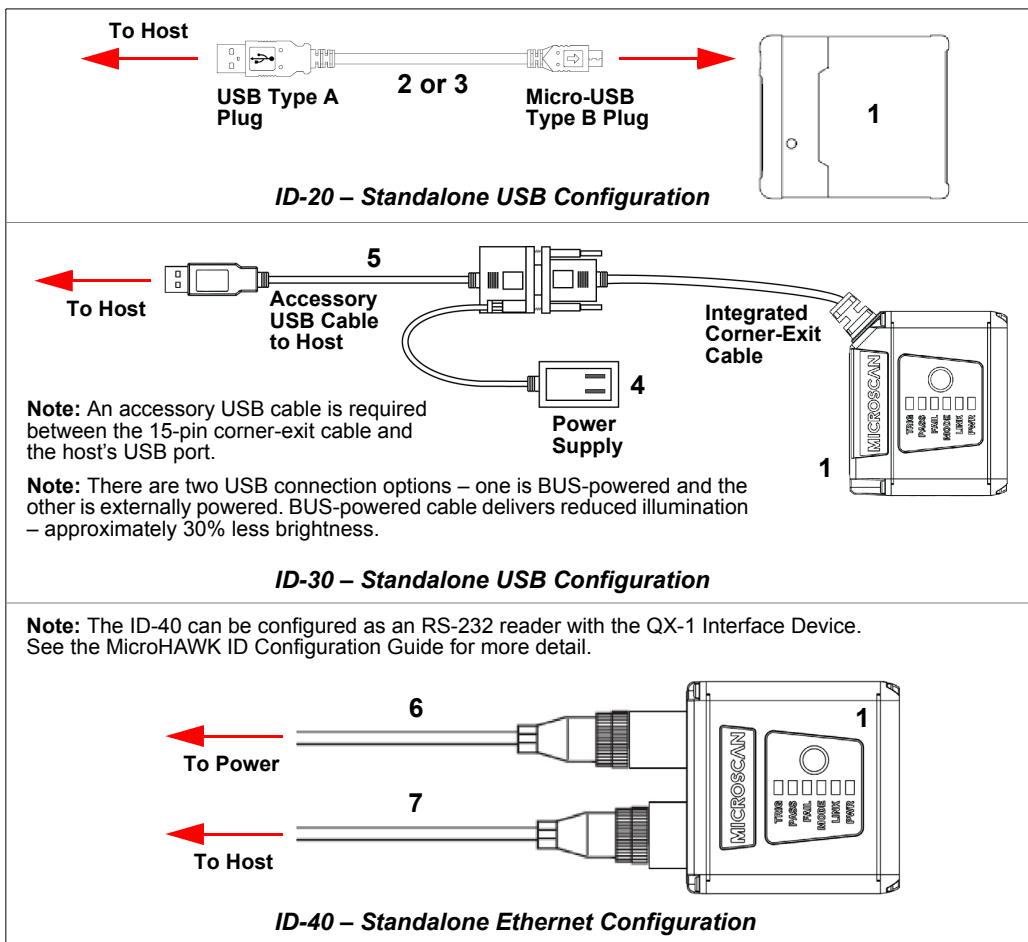

Step 2 — Mount and Position the Reader

- Position the reader several inches from the symbol. You may need to reposition the reader a few times to find the ideal distance.
- Tip the reader relative to the symbol to avoid the glare of direct (specular) reflection.
- Symbols can be rotated (tilted) at any angle; however, for best results symbols should be aligned with the field of view. In the case of linear symbols, aligning the bars in the direction of their movement (ladder orientation) will minimize the chances of blurring and will result in more consistent decodes.

Important: Avoid excessive skew or pitch. Maximum skew is $\pm 30^\circ$; maximum pitch is $\pm 30^\circ$. The illustration below shows approximate skew axis, pitch axis, and tilt axis.

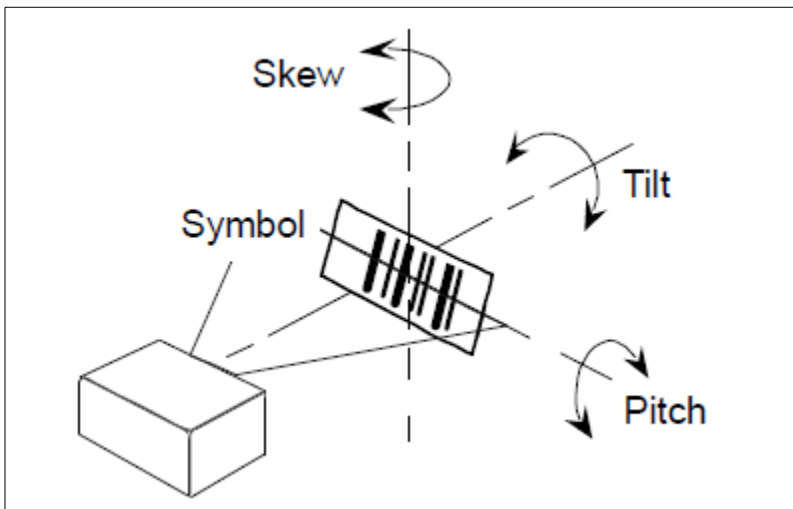

Reader and Symbol Orientation

Step 3 — Install WebLink Drivers (ID-20 and ID-30)

1. Plug the reader into a USB port and wait for the **AutoPlay** dialog to appear.
2. Click **Open folder to view files** and double-click the **Double-Click Here.bat** batch file.
3. At the command prompt, select **option 1** and then type **Enter**. **VCOM** and **USBLAN** drivers are installed.
4. At the command prompt, select **option 2** to install the WebLink and FTP drive shortcuts. WebLink and MicroHAWK FTP drive shortcut icons will appear on the desktop.
5. When installation of the drivers and shortcuts is complete, unplug the reader from the USB port.
6. Re-plug the the reader into the USB port and wait for the reader to reboot and to enter read mode (LEDs **ON**).
7. Double-click the WebLink desktop shortcut. WebLink will load and start. (See **Step 4 – Connect to WebLink.**)
8. Double-click the FTP drive shortcut and log in with username: **target** and password: **password**.
9. The FTP drive is opened so you can access additional resources and installers in the **Tools and Documentation** folder.

You are now ready to use the MicroHAWK ID-20 or ID-30 with WebLink.

Step 1

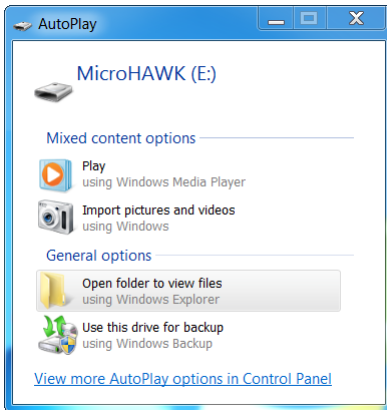

Step 3

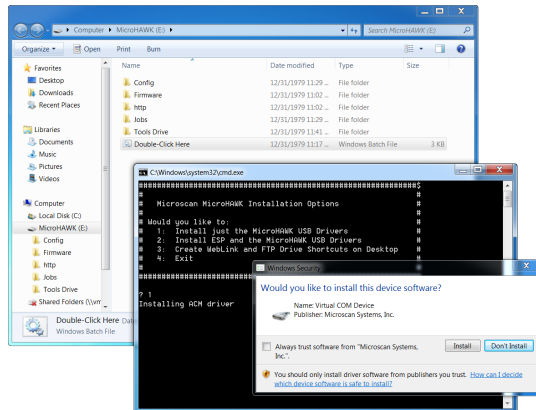

Step 4 — Connect to WebLink

MicroHAWK ID-20 and MicroHAWK ID-30

When you double-click the WebLink desktop shortcut or enter the reader's IP address directly in the address bar of your web browser, WebLink will load and start.

Note: WebLink is the preferred user interface for MicroHAWK ID Readers, but Microscan's **ESP Software** can also be used for configuration and testing. ESP is useful in the following circumstances:

- Device discovery to find the reader IP address;
- If you only have an RS-232 (serial) connection;
- Updating MicroHAWK ID firmware;
- Using the Configuration Database;
- Creating barcodes for reader configuration;
- Generating Symbol Quality reports.



MicroHAWK ID-40 (Static Connection)

1. Navigate to **Control Panel > Network and Sharing Center** on your PC.
2. Click **Local Area Connection 4**. In the **Status** dialog, click **Properties**.
3. In the **Local Area Connection Properties** dialog, select **Internet Protocol Version 4 (TCP/IPv4)** and click **Properties** again. Set your PC to a **192.168.188.X** IP address (**192.168.188.5**, for example).
4. Click **OK**.
5. Open a web browser and type the reader's default IP address (**http://192.168.188.2**) in the web browser's address bar.

The reader will connect to WebLink.

MicroHAWK ID-40 (DHCP Network Connection)

1. Plug your reader into the your network adapter.
2. Open **ESP Software** and connect to the **MicroHAWK ID-40** via **Ethernet TCP/IP**.
3. Click **Search** to find the reader. When the reader appears in the field below the **Search** and **Send** buttons, select it.
4. Change the reader from **Static** to **DHCP** and click **Send and Save**. The camera will reboot and ESP will search for the reader again.
5. When the ID-40 is found, note the new IP address that is generated.
6. Open a browser and type the new IP address.

WebLink will load.

Step 5 — Explore the Start View

The **Start** view is the initial view you will see when the session begins. The connected reader is shown, along with its **user-defined name** (19 characters or fewer), **IP address**, **Reader Model**, **Serial Number**, **MAC ID**, **Firmware Version**, **Sensor**, **Optics**, **Decoder**, and **Speed**. This view allows you to choose **Assisted Setup**, to **Create a New Setup**, or to **Load a Setup**.

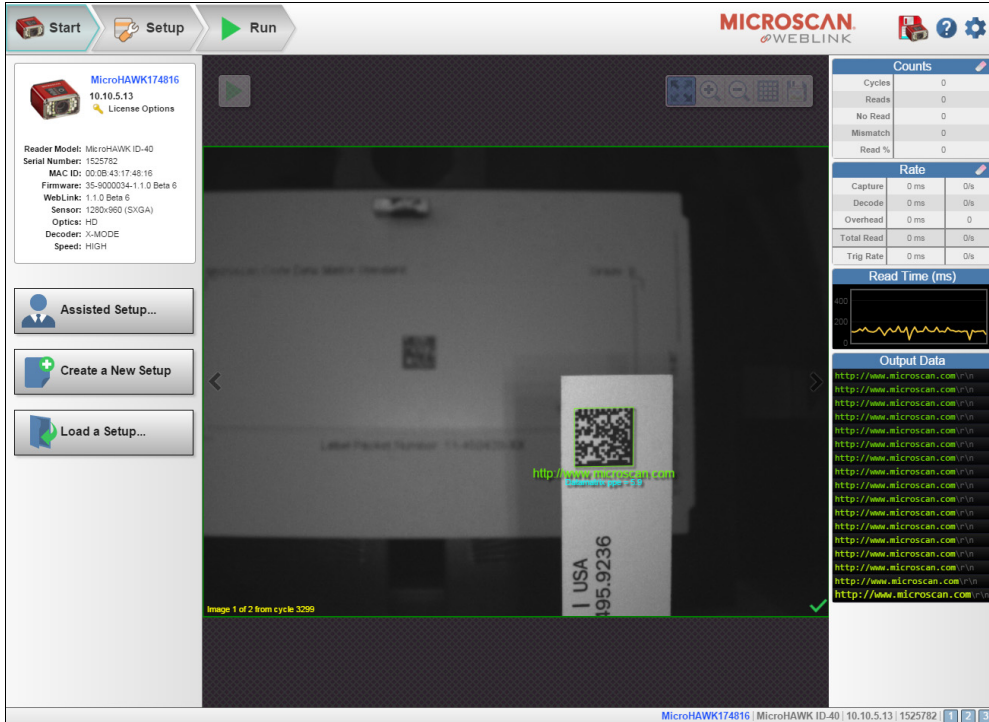

Click the gear icon to open the **Application Settings** menu, which gives you access to several functions: **Save**, **New**, **Load**, **Advanced**, **Language**, **Terminal**, **Beeper**, **Guided Tour**, **Image Storage**, **Restore Default Settings**, **Manage Login**, **Enable USB Drive Mode**, **WebLink Branding Utility**, and **About Weblink**.

Note: The **Enable USB Drive Mode** option only appears when you are using an ID-20 or ID-30, which support USB connectivity.

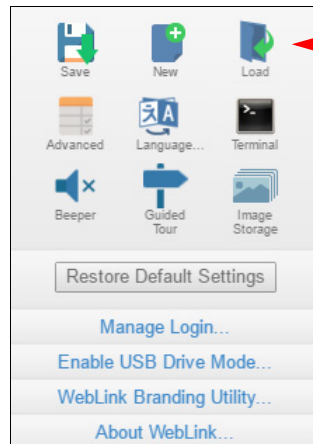

Step 6 — Create a New Setup or Load an Existing Setup

Assisted Setup

When you click the **Assisted Setup** button in the **Start** view, a dialog will appear asking you a series of application-based questions. Based on your answers, WebLink generates your initial setup automatically. Once the setup is created, you can fine-tune its parameters in the **Setup** view.

Create a New Setup

The Start view also allows you to **Create a New Setup** without using Assisted Setup. When you click the Create a New Setup button, WebLink searches for any differences from default in the reader parameters. If no differences from default are found, you will see the Setup view. If differences from default are found, an alert will appear asking if you want to restore default settings.

Load a Setup

Select **Load a Setup** to load an existing **.json** WebLink setup file. You can also load an **.esp** or **.txt** file from Microscan's **ESP Software**.



Step 7 — Explore the Setup View

The **Setup** view allows you to configure all aspects of a setup. Multiple discrete sections of the interface give you the ability to set **Cycle**, **Acquire**, **Decode**, **Match String**, **Format Output**, **Output parameters**, and **Favorites**.

Clicking the **Save** icon at the upper right saves current settings to the reader's flash memory so the settings will be available when the reader is rebooted.

The **question mark** icon at the upper right opens **WebLink Help**.

The **gear** icon at the upper right brings up the **Application Settings** menu.

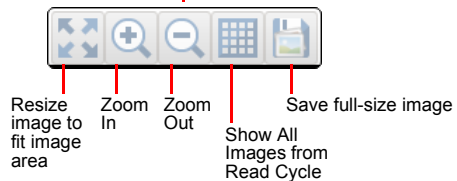
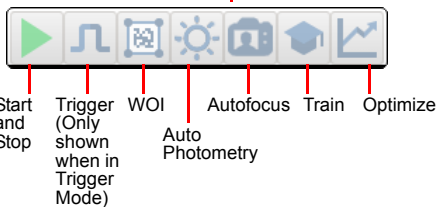
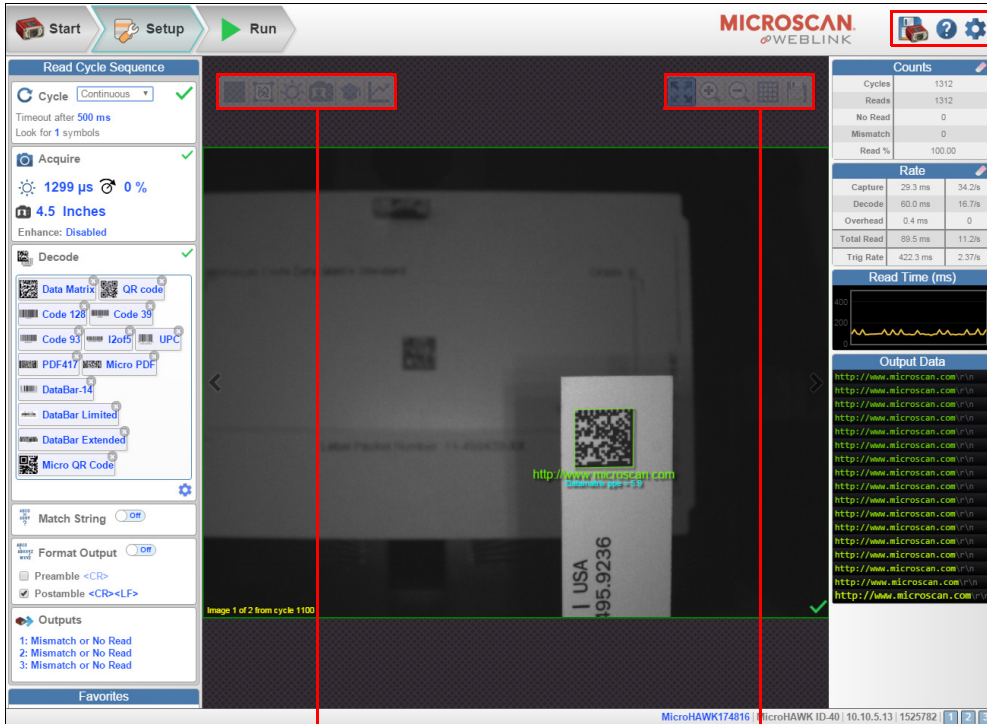

Step 8 — Configure Read Cycle Settings

The **Cycle** section of the **Setup** view allows you to modify the trigger, determine the number of symbols for the reader to expect, and set **Read Cycle Timeout**. A dropdown menu of various Cycle types provides a variety of options, each with configurable parameters.

Presentation

This mode uses **Continuous Read Auto** along with **Continuous Capture Mode** and a **Timeout at End of Read Cycle**. **Green Flash Mode** is set to **Static Presentation** and the **Green Flash Duration** is set to **1 second**.

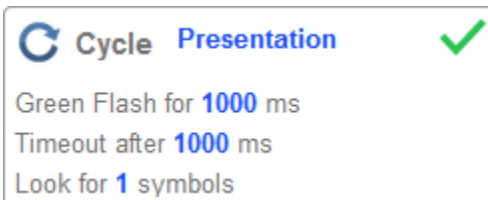

Continuous

This mode allows you to set the **Read Cycle Timeout** and the expected **Number of Symbols** from **1** to **100**.

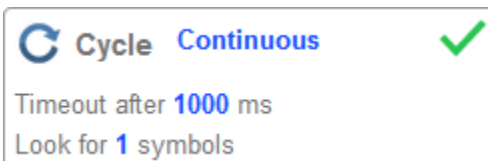

Triggered

This mode sets the read cycle to **Serial Data and Edge**, **End of Read Cycle** is set to **Timeout or New Trigger**, and **Capture Mode** is set to **Rapid Capture** with **1 capture**. You can adjust the **Serial Trigger**, **Trigger Delay**, **Timeout**, and **Number of Symbols**.

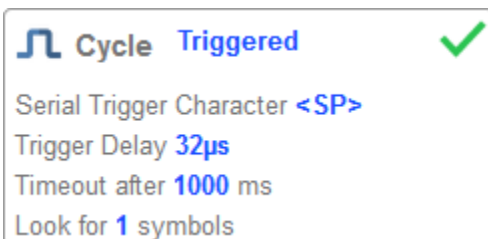

Start / Stop

This mode uses **External Level** with a **Read Cycle Timeout** and **Continuous Capture**, allowing you to set **Leading Edge** and **Trailing Edge** as well as the **Serial Trigger** and the **Start** and **Stop** characters.

Serial Trigger (Non-Delimited) Off

When **Serial Trigger** is set to **Off**, the start and stop characters are set to **NULL**, meaning that the trigger is disabled.

Serial Trigger (Non-Delimited) On

When **Serial Trigger** is set to **On**, the start and stop characters are set to **S** and **E**. When the trigger button is clicked, it will use the current start and stop non-delimited triggers.

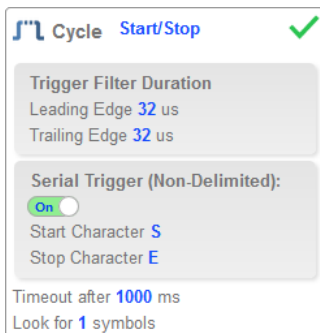

Custom

This mode allows you a wider variety of read cycle scenarios, including **Continuous Read Auto**. Use this mode to select **Trigger** mode and to set **Serial Trigger Character** and **Trigger Delay**; to select **Capture** mode and to set **Number of Captures**, **Rapid Capture** mode, and **Delay between Images**; and to select the **End Cycle On** setting as well as **Timeout** and **Number of Symbols**.

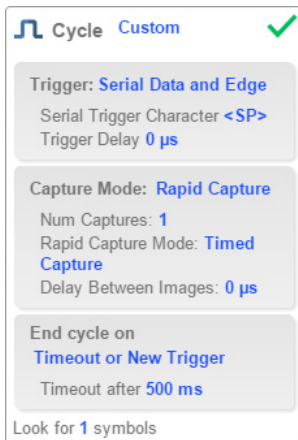

Step 9 — Configure Acquire Settings

Acquire settings allow you to set **Exposure** (signified by the sun icon) and **Gain** (signified by the dial and right-pointing arrow icon) in real time. Clicking any of these settings will cause a control to appear, allowing you to modify that setting. Settings take effect immediately.

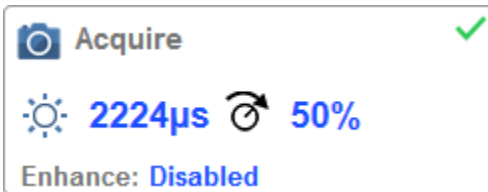

Standard

When **Auto Photometry** is enabled instead of **Standard**, Exposure and Gain are read-only. The **A** shown on the sun and dial icons signifies that Auto Photometry is enabled. Auto Photometry constantly determines the best Exposure and Gain settings during each read cycle.



Auto Photometry

Autofocus

Autofocus can be enabled and disabled in the **Image Area** using the focus button in the **Device Control Toolbar**, and can be configured in the **Acquire** section of the **Setup** view.

While in **Continuous** mode or **Continuous Auto** mode, the camera can enable or disable Autofocus functionality, allowing it to refocus after a number of no reads. The focus button shows an **A** when Autofocus is enabled. The focus distance is updated on the fly based on the latest refocus settings.

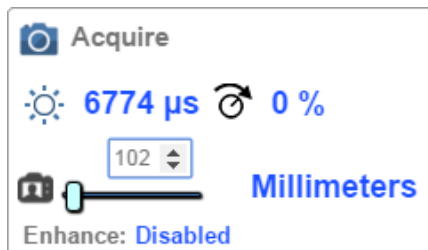
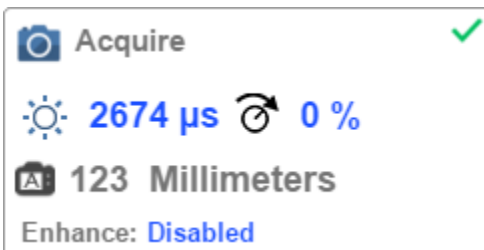

Spot Focus

If the camera is in **Continuous** mode or **Continuous Auto** (Continuous mode with **Auto Photometry** enabled), you can perform a localized quick focus in the image.

If you click the focus button, the **Autofocus** and **Spot Focus** icons appear:

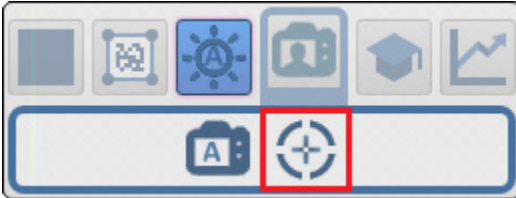

When you click the Spot Focus icon, the **Select a location in the image to autofocus** message appears:

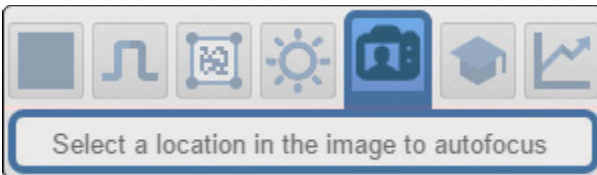

The cursor transforms into crosshairs as shown in the example below. This allows you to select the section of the image in which you want to perform a quick focus.

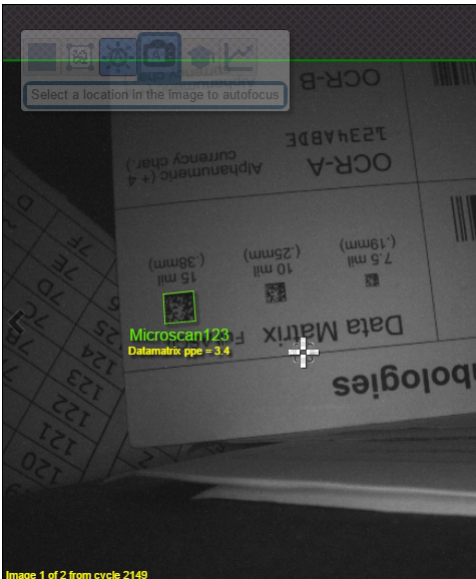

Note: If you click the Autofocus button to the left of the Spot Focus button, the reader will switch from Spot Focus to regular Autofocus functionality. If the reader is in **Triggered** mode, only the Spot Focus icon will appear.

Enhance

The **Enhance** dropdown menu at the bottom of the **Acquire** settings editor allows you to select the method for processing captured images.

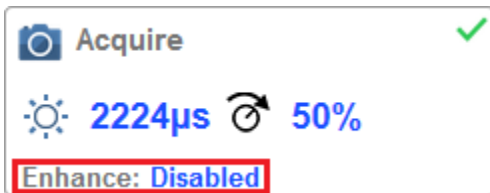

Grow Dark

Grow Dark increases the dark cell size of a symbol. It is useful for increasing the dark cell size of a dark-on-light Data Matrix symbol.

Shrink Dark

Shrink Dark increases the light cell size of a symbol. It is useful for increasing the light cell size of a light-on-dark Data Matrix symbol.

Connect Dark

Connect Dark removes minor light defects of dark cells.

Separate Dark

Separate Dark removes minor dark defects of light cells.

Operator Size

The **Operator Size** dropdown menu determines the size of the area or “pixel neighborhood” in which the enhance operation is being performed.

Small

Small corresponds to an area of **3 pixels by 3 pixels**.

Medium

Medium corresponds to an area of **5 pixels by 5 pixels**.

Large

Large corresponds to an area of **7 pixels by 7 pixels**.

Step 10 — Configure Symbology Settings

Clicking the gear icon at the bottom of the **Decode** dialog brings up **Symbology Settings**. This allows you to configure every parameter for every available code type.

Symbology Settings		
Data Matrix	☆ ECC 200 Status	Enabled
Code 128	☆ ECC 000 Status	Disabled
Code 39	☆ ECC 050 Status	Disabled
Codabar	☆ ECC 080 Status	Disabled
Code 93	☆ ECC 100 Status	Disabled
Interleaved 2 of 5	☆ ECC 140 Status	Disabled
UPC/EAN	☆ ECC 120 Status	Disabled
PDF417	☆ ECC 130 Status	Disabled
Micro PDF417		
BC412		
Pharmacode		
DataBar Expanded		
Postal Symbologies		

Data Matrix error correction parameters are shown in this example, but you can configure any parameter for any of the code types supported by WebLink. All parameter changes for all code types take effect immediately.

Step 11 — Format Output and Configure Match String

Format Output, when enabled in the **Setup** view, allows you to determine the many ways in which barcode data can be formatted and parsed before it is output as a data string. You can also set **Preamble** and **Postamble** in this dialog.

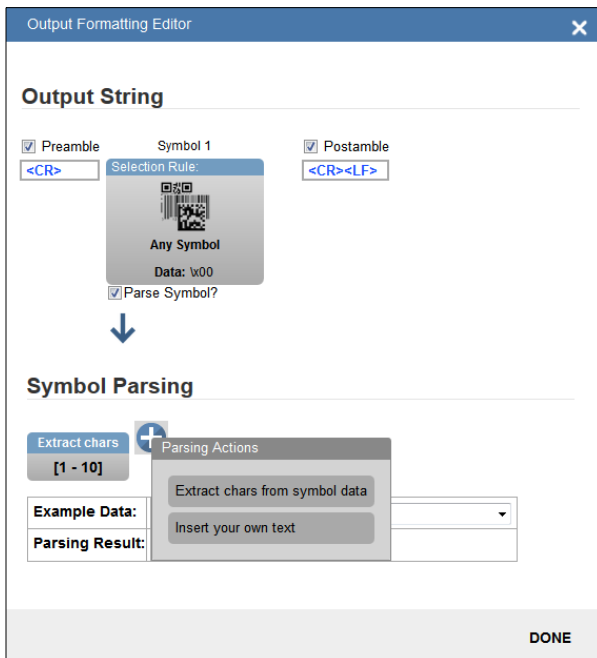

Match Options and **Match String Database**, accessible by clicking the **Match String** section in the **Setup** view, allow you to set the match code mode, text output, new master, and match string database.

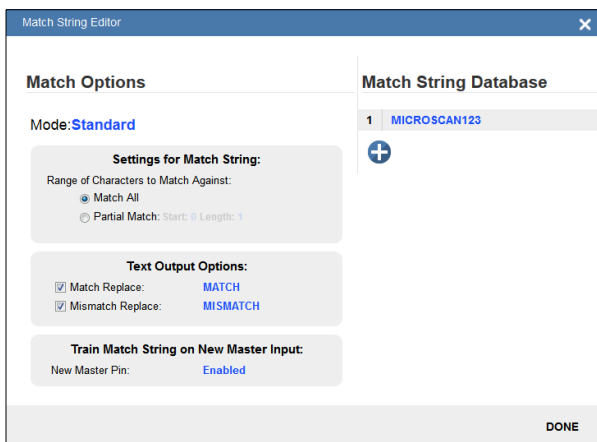

Step 12 — Configure Output 1, 2, and 3 Settings

Bring up the **Output 1**, **Output 2**, and **Output 3** dialogs by clicking on the **Outputs** section at the lower left of the **Setup** view. For each output you can determine the **Output On** behavior, **Mode**, **Pulse Width**, and **State**. Outputs 2 and 3 also allow you to determine output behavior based on **Trend Options** parameters or **Verification Options** parameters.

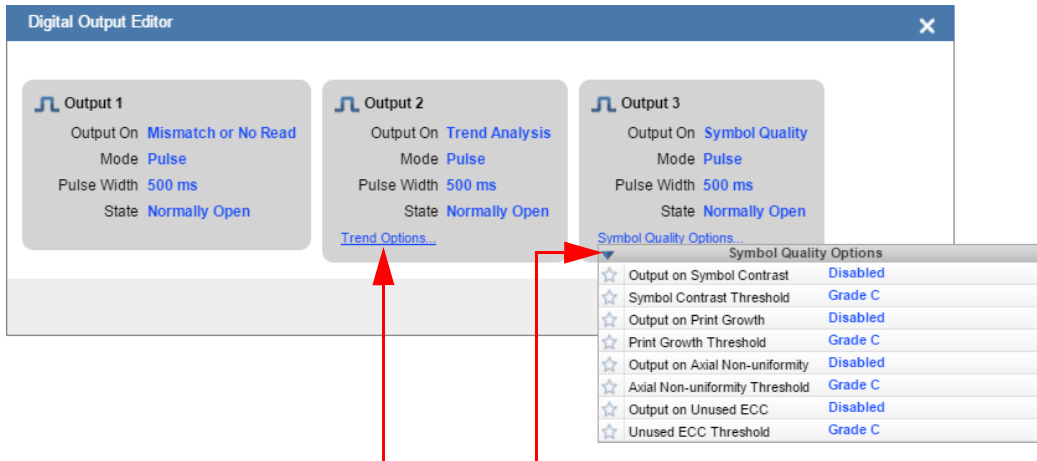

This example shows the dialog that appears when you click **Symbol Quality Options**. A similar dialog would appear for **Trend Options** under **Output 2**.

Step 13 — Run the Application

In the **Run** view, you can observe the progress of the setup as it follows the parameters you have defined. The right panel of the UI shows **Counts** for **Cycles**, **Reads**, **No Reads**, and **Mismatches**, as well as **Rate** information for **Capture**, **Decode**, **Overhead**, **Total Read**, and **Trigger Rate**, as well as **Output Data**. A "filmstrip" below the **Image Area** shows each image capture with a **green check mark** for a good read and a **red x** for a no-read.

The screenshot displays the Microscan WEblink application interface in the **Run** view. The main window shows a live video feed of a document with a QR code. The QR code is highlighted with a green box and a green checkmark. Below the QR code, the text "USA 195.9236" is visible. The interface includes a top navigation bar with "Start", "Setup", and "Run" buttons. On the right, there are three panels: "Counts", "Rate", and "Read Time (ms)".

Counts

Cycles	1338
Reads	1338
No Read	0
Mismatch	0
Read %	100.00

Rate

Capture	58.6 ms	17.1/s
Decode	84.1 ms	15.6/s
Overhead	0.0 ms	0
Total Read	93.8 ms	10.7/s
Trig Rate	95.7 ms	10.45/s

Read Time (ms)

The graph shows a fluctuating yellow line representing read time in milliseconds, ranging from 0 to 400 ms.

Output Data

The output data panel displays a list of URLs: `http://www.microscan.com/r/n`.

At the bottom, a filmstrip shows a sequence of image captures, each with a green checkmark. The status bar at the bottom indicates: `MicroHAWK174816 | MicroHAWK ID:40 | 10.10.5.13 | 1525782 | 1 | 2 | 3 | 4`.

MicroHAWK ID and ESP Software Quick Start

Step 1 — Check Hardware and Connect the System

Item	Description	Part Number
1	MicroHAWK ID-20, MicroHAWK ID-30, or MicroHAWK ID-40	7AXY-YZZZ-LPPP
2	Cable, USB A to Micro B, 6 ft., ID-20	61-9000034-01
3	Cable, USB A to Micro B, 3 ft., ID-20	61-9000045-01
4	Power Supply, 5V	97-9000006-01
5	Cable, DB15 to Ext. Power/USB, ID-30	61-9000038-01
6	Power Supply, 100-240VAC, +24VDC, M12 12-Pin Socket	97-000012-01
7	Cordset, Host, Ethernet, M12 8-Pin Plug (Screw-On) to RJ45, 1 m.	61-000160-03

Note: See the *MicroHAWK ID-20 / ID-30 / ID-40 Configuration Guide* for all configurations.

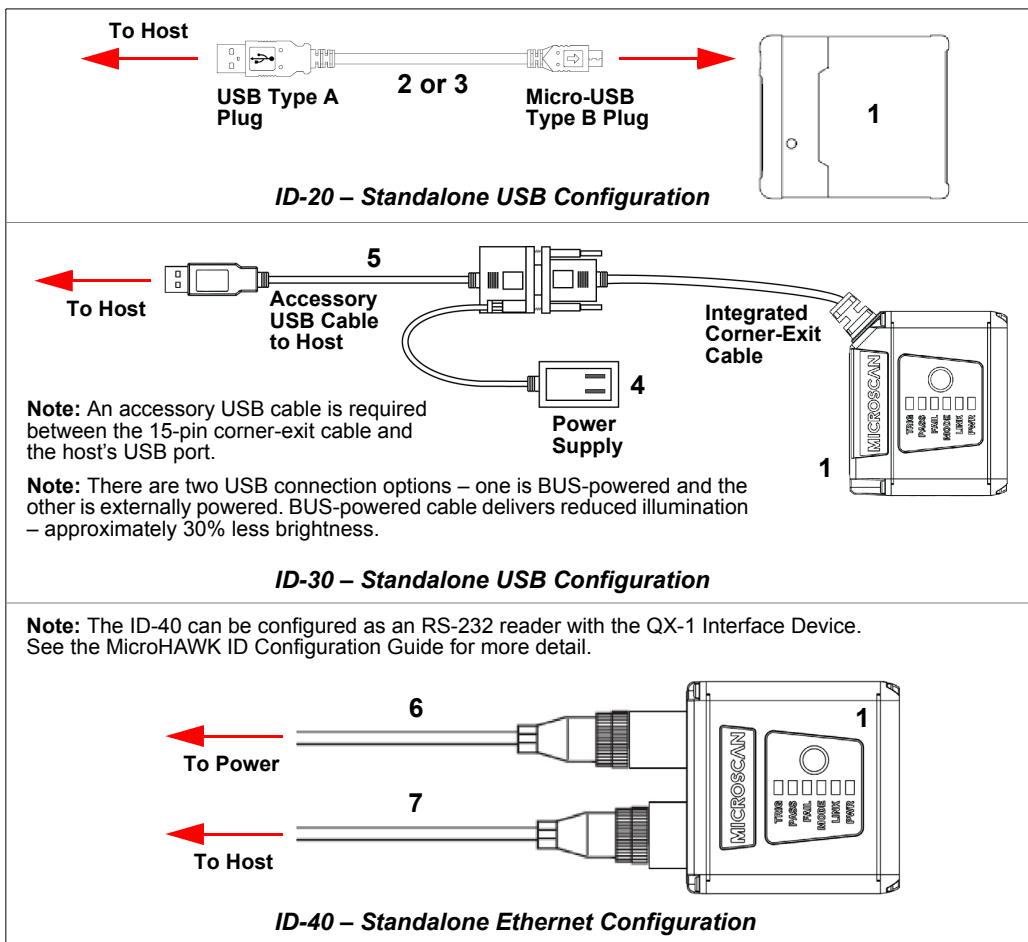

Step 2 — Mount and Position the Reader

- Position the reader several inches from the symbol. You may need to reposition the reader a few times to find the ideal distance.
- Tip the reader relative to the symbol to avoid the glare of direct (specular) reflection.
- Symbols can be rotated (tilted) at any angle; however, for best results symbols should be aligned with the field of view. In the case of linear symbols, aligning the bars in the direction of their movement (ladder orientation) will minimize the chances of blurring and will result in more consistent decodes.

Important: Avoid excessive skew or pitch. Maximum skew is $\pm 30^\circ$; maximum pitch is $\pm 30^\circ$. The illustration below shows approximate skew axis, pitch axis, and tilt axis.

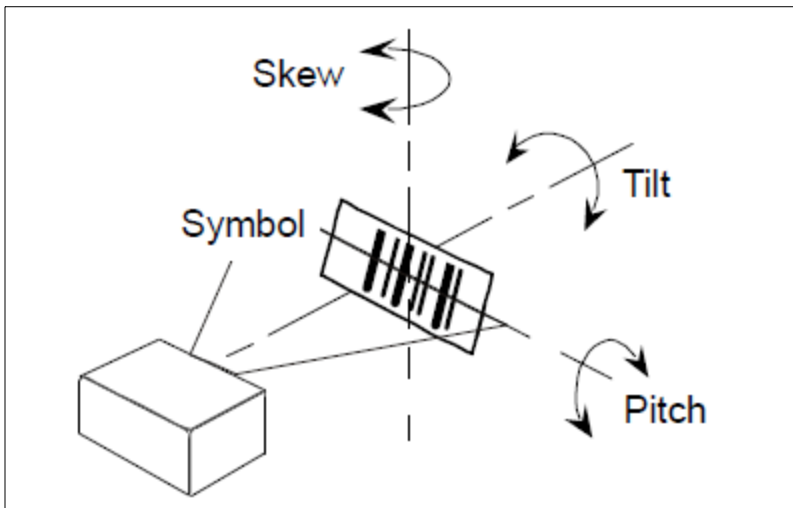

Reader and Symbol Orientation

Step 3 — Install ESP

ESP Software can be found on Microscan's **Tools Drive (37-00010-01)** that is packaged with the reader if the Drive was ordered at the time of purchase. ESP can also be installed from the **Download Center**, located at: www.microscan.com.

- Follow the prompts to install ESP from the Microscan Tools Drive or Download Center.
- Click the ESP icon on your desktop to run the program.



Minimum System Requirements

- 233 MHz Pentium® PC
- Windows® 8, 7, Vista, or XP operating system (32-bit or 64-bit)
- Internet Explorer® 6.0 or higher
- 128 MB RAM or greater
- 160 MB free disk space
- 800 x 600 256 color display (1024 x 768 32-bit color recommended)

Step 4 — Select Model

When you start **ESP**, the following menu will appear:

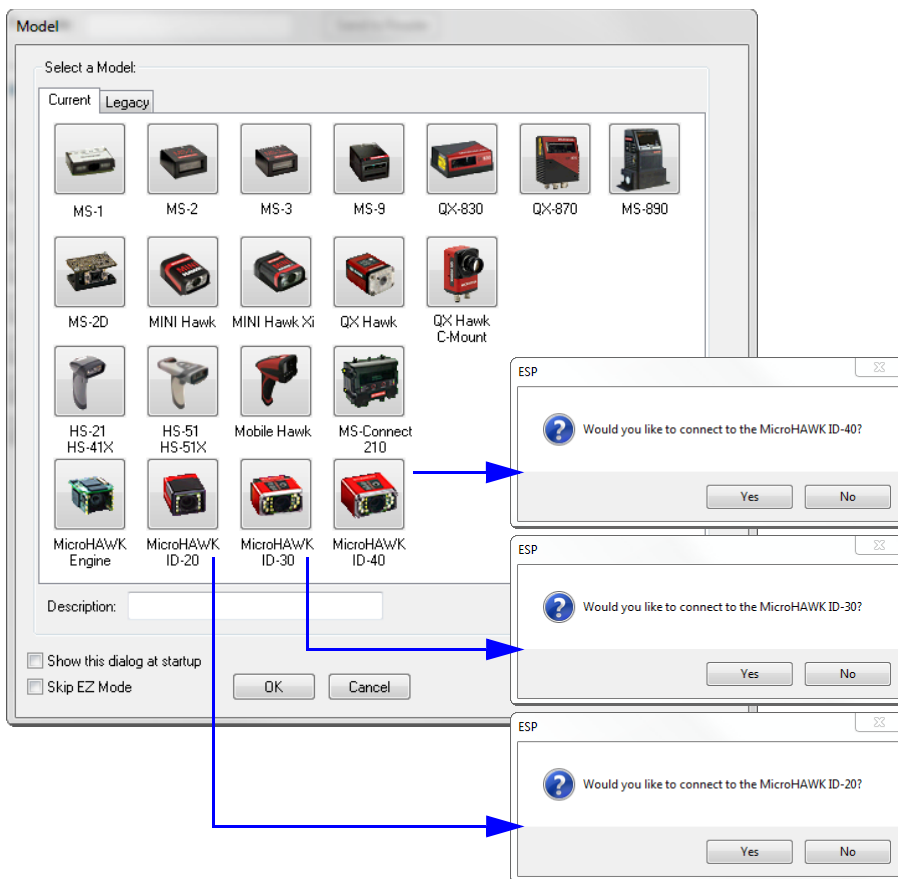

1. Click the button showing your version of the MicroHAWK.
2. Click **OK** or double-click one of the MicroHAWK buttons to select your reader.
3. Depending on the MicroHAWK version you have selected, you will see the appropriate **Would you like to connect to the MicroHAWK ID-[XX]?** dialog after selecting your reader and clicking **OK**.
4. Click **Yes** when asked if you would like to connect.

Note: If you need to select another model later, click the **Switch Model** button near the top of the screen or use **Model > New Model** in the menu toolbar.

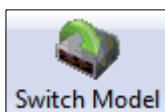

Step 5 — Connect

- Click **Connect** on the menu toolbar, and then select **Connection Wizard**.
- Select the communication interface required by your application.
- Configure settings as required by the application, and click **Connect**.

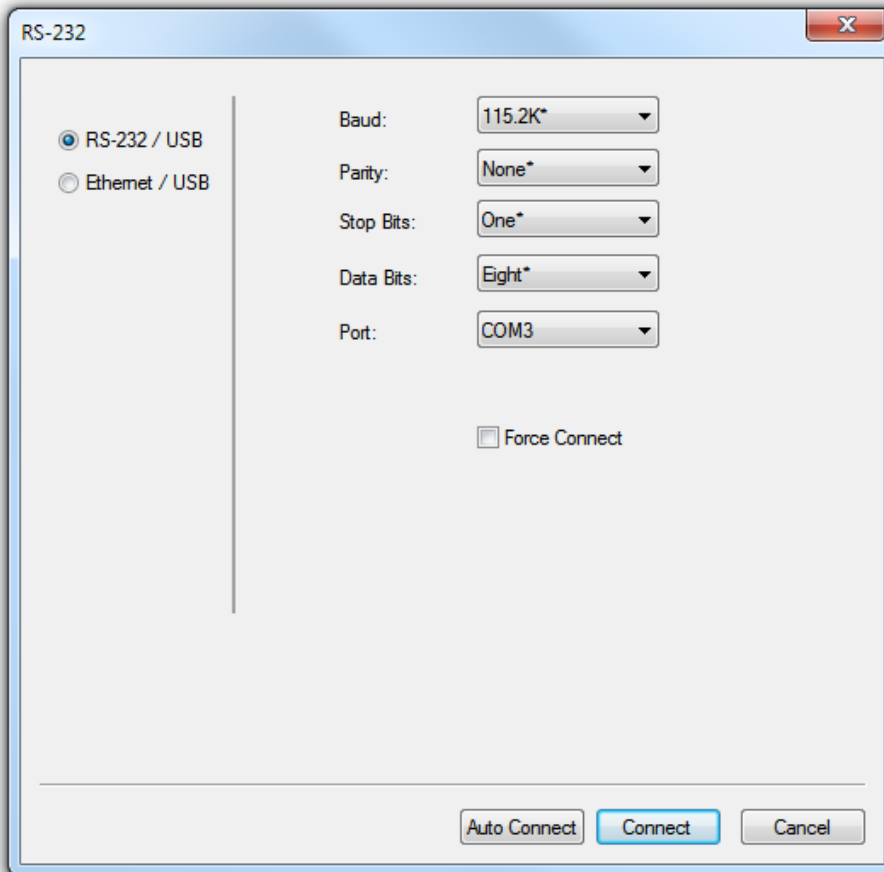

- When a connection is established, the green indicator in the status bar at the bottom right of the screen will be visible:

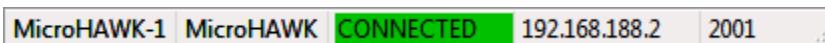

Important: For best connection results, be sure that no decodable symbols are within the reader's field of view while attempting to connect.

Step 6 — Locate the Symbol in the Field of View

- In ESP's **EZ Mode**, click the **Locate** button to enable the blue target pattern.

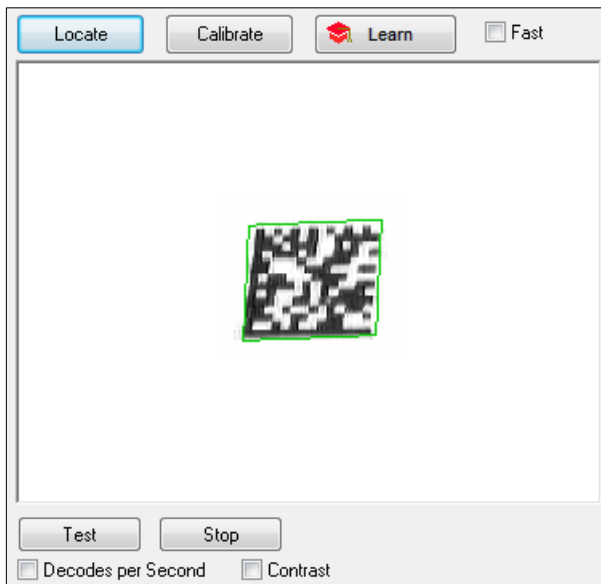

The symbol in the field of view will appear in the video view beneath the **Locate** and **Calibrate** buttons, and you will see the blue target pattern projected from the front of the reader.

- Center the target pattern on the symbol.
Important: The entire symbol should fall within the field of view (FOV) of the reader. The field of view is what appears in **ESP's Locate/Calibrate** window in **EZ Mode**.
- Click the **Stop** button to end the **Locate** function.



Step 7 — Calibrate

MicroHAWK ID settings can be adjusted automatically in **ESP** for optimum symbol decoding performance.

During the calibration routine, the reader will flash its amber Read Rate percent LEDs and red illumination LEDs while searching camera settings and determining the best configuration for decoding symbol data. Upon successful completion of this routine, a green LED pattern will flash brightly and illuminate the symbol.

Calibrate by ESP

- Click the **Calibrate** button.



- The reader will search camera settings to determine the best configuration for decoding symbol data.

A successful calibration will display a green frame around the symbol, and the following message will appear: **Uploading all reader parameters**. After a moment the symbol data will be presented in the field below the image display window.

Note: If you choose to calibrate the reader by sending a **<@CAL>** command, a decode is also required for the calibration process to be completed successfully.

Step 8 — Test Read Rate

Read Rate indicates the number of successful decodes per second achieved by the reader.

Test Read Rate by ESP

1. Click the **Test** button to start the Read Rate test and **Stop** to end it.

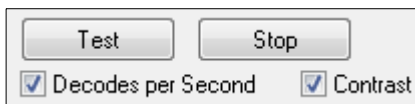

If a symbol has been successfully decoded, the symbol's data and related features will be presented in the field below the image display window. Also, while the symbol is being inspected, the Read Rate LEDs will indicate the corresponding Read Rate percentage on the back of the unit.

2. To end the test, click the **Stop** button.

Note: Read Rate can also be tested using the **Read Rate** interface in **Utilities**.

Test Read Rate by Serial Command

You can also start a test with the **<C>** or **<Cp>** command and end it with the **<J>** command.

Step 9 — Configure the Reader in ESP

Click the **App Mode** button to make configuration changes to the MicroHAWK ID reader.

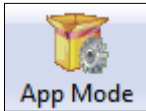

The following modes are accessible by clicking the buttons in the first row of **App Mode** icons:



- Click **EZ Mode** to return to EZ Mode from App Mode.
- Click **Autoconnect** to establish communication (appears as **Connect** for the ID-40).
- Click **Send/Recv** to send or receive commands.
- Click **Switch Model** to open the model menu, to return to a previous reader model, or to remove a previous reader model.
- Click **Parameters** to show the tabbed tree controls for **Communication**, **Read Cycle**, **Symbologies**, **I/O Parameters**, **Symbol Quality**, **Matchcode**, and **Diagnostics**.
- Click **Setup** to access a **Camera Setup** tree control and the tabbed user interfaces for **Video**, **Evaluation**, **Calibration**, **WOI (Window of Interest)**, **Configuration Database**, **Ordered Output**, **Output Format**, and **Dynamic Setup**.
- Click **Terminal** to display decoded symbol data and to send serial commands to the reader using text or macros.
- Click **Utilities** to access the tabbed user interfaces for **Read Rate**, **Counters**, **Device Control**, **Differences from Default**, **Master Database**, and **Firmware**.

Step 10 — Save Configuration in ESP

To make changes to a configuration setting:

1. **Left-click** on the **+** to expand the desired tree.
2. **Double-click** on the desired parameter and click once in the selection box to view options.

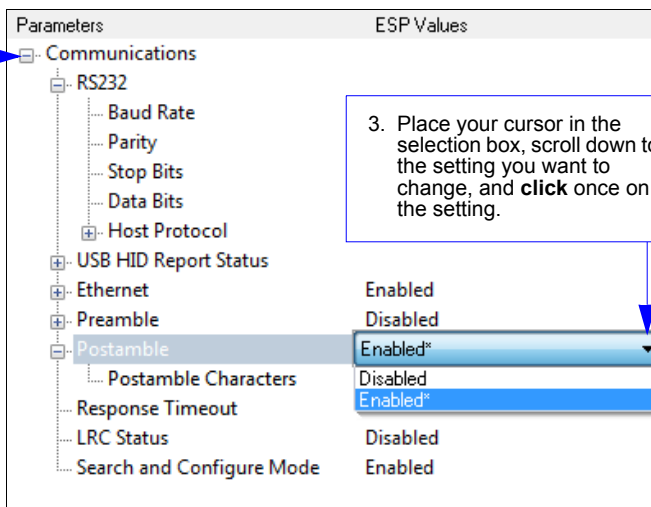

4. **Left-click** again on the open screen to complete your selection.
5. **Right-click** on the open screen and select **Save to Reader** to implement the command in the reader.

Saving Options

- **Send, No Save.** Changes will be lost when power is re-applied to the reader.
- **Send and Save.** This activates all changes in current memory *and* saves to the reader for power-on.

MicroHAWK ID Part Number Structure

MicroHAWK ID part numbers follow the format **7ABX-YZZZ-LPPP**.

7 = MicroHAWK.

Example Part Number: 7312-2000-1005

Description: MicroHAWK ID-30, Auto ID, IP54 Enclosure, 5V, USB, SXGA 1.2 Megapixel, Mono, High Density, Autofocus, Red Outer LEDs, High Speed X-Mode Decoder.

(A) Model

- 1: Engine, No Case, USB
- 2: ID-20, IP40 Case, USB
- 3: ID-30, IP54 Case, 5V, USB
- 4: ID-40, IP65 Case, 24V, Ethernet

(B) Software

- 1: Auto ID

(X) Sensor

- 1: WVGA 0.3 Megapixel, Mono
- 2: SXGA, 1.2 Megapixel, Mono
- 3: QSXGA, 5 Megapixel, Color

Sensor Table

	Pixels (H x V)	Shutter	Frames per Second (Standard / High)
WVGA	752 x 480, 0.3 MP, Mono	Global	10 fps / 60 fps
SXGA	1280 x 960, 1.2 MP, Mono	Global	10 fps / 42 fps
QSXGA	2592 x 1944, 5 MP, Color	Rolling	5 fps

(Y) Optics

- 0: Custom
- 1: Standard Density
- 2: High Density

(ZZZ) Focus Distance

- 000: Autofocus
- 050: 50 mm = 1.96 in.
- 064: 64 mm = 2.51 in.
- 081: 81 mm = 3.18 in.
- 102: 102 mm = 4.02 in.
- 133: 133 mm = 5.23 in.
- 190: 190 mm = 7.48 in.
- 300: 300 mm = 11.81 in.

(L) Outer LED Color

- 0: N/A (Engine and ID-20)
- 1: Red
- 2: White

(PPP) Speed and Decoder

- 000: Standard Speed, 1D Decoder
- 001: High Speed, 1D Decoder
- 002: Standard Speed, 1D/2D Decoder
- 003: Standard Speed, X-Mode Decoder
- 004: High Speed, 1D/2D Decoder
- 005: High Speed, X-Mode Decoder

Notes:

- **(A) Model:** The MicroHAWK Engine is available for OEM-certified partners only.
- **(L) Outer LED Color:** Outer LEDs provide extra illumination. Base level illumination included with all readers.
- **(PPP) Speed and Decoder:** 1D omnidirectional decoding functionality is included with all readers. The 1D/2D Decoder option is useful for printed labels. X-Mode is the full decoder package for 1D, 2D, DPM, and damaged symbols.
- **Field Upgrades:** Not available for optics or illumination due to factory settings for optical alignment, LED balancing, and sealing for IP enclosure rating. However, the reader's speed and decoder version are field-upgradeable via licenses.

2 Using ESP

Contents

EZ Mode.....	2-2
App Mode.....	2-3
Menu Toolbar.....	2-4
View.....	2-13
Navigating in ESP.....	2-14
Send/Receive Options.....	2-15

This section is designed to help you understand the basic structure and elements of **ESP** (**E**asy **S**etup **P**rogram).

When you open **ESP**, unless otherwise specified in the **ESP Preferences** dialog accessible from the **Options** heading on the menu toolbar, you will enter **EZ Mode** for initial setup. From there, you can enter **App Mode**, where you can access several configuration menus: **Communications**, **Read Cycle**, **Symbologies**, **I/O Parameters**, **Symbol Quality**, **Matchcode**, and **Diagnostics**, as well as a **Camera Setup** interface, a **Terminal** interface, and a **Utilities** interface.

ESP can be used to configure the MicroHAWK ID in three different ways:

- **Tree Controls:** Each configuration menu contains a list of all commands and command parameters that pertain to that specific element of reader operation. For example, the **I/O Parameters** menu shows a **Calibration Options** command (which corresponds to the <K529> serial command), and then a list of the parameters **Gain**, **Exposure**, **Symbol Type**, **Window of Interest Framing**, **Window of Interest Margin**, **Linescan Height**, and **Processing**. Each of these parameters is configurable dropdown menus and spin boxes.
- **Graphic User Interfaces:** Reader settings can be configured using radio buttons, sliders, spin boxes, check boxes, and various drag-and-drop functions.
- **Terminal:** **ESP**'s **Terminal** allows you to send serial commands directly to the reader by typing them in the **Send** text field.

For **ESP** system requirements, see **Minimum System Requirements** in the **Install ESP** step of the **Quick Start** section.

EZ Mode

In **EZ Mode** you are presented with the **Locate**, **Calibrate**, and **Test** options. After connecting to your reader, **EZ Mode** is the screen you will see. You will be provided with on-screen instructions that will help you with positioning, testing, and calibration.

Test

Click the **Test** button to start the Read Rate test for a quick indication of the reader's read capabilities and the limits of your application. When **Decodes per Second** is unchecked, the test will count the percentage of decodes relative to the number of actual scans. Click **Stop** to end the test.

Calibrate

The calibration routine that will optimize the reader by comparing Read Rates at various camera and image processing settings.

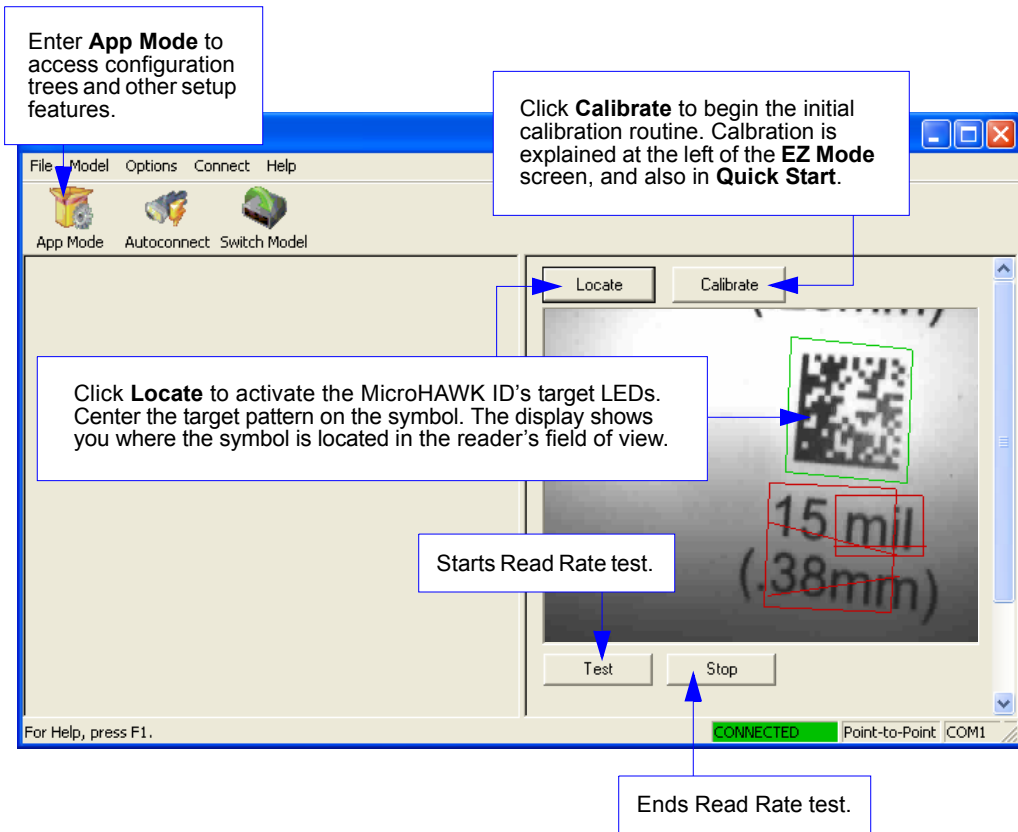

Menu Toolbar

File > New

Whenever **New** is selected, the default configuration of **ESP** is loaded.

Open/Save

When **Save** or **Save As** is selected, the **ESP** configuration is saved to the host computer's hard drive and available whenever the same file is selected under **Open**.

Important: When you save menu changes to your hard drive, these changes are not saved to your reader. The illustration below shows how settings can be saved and received between **ESP** and the reader, and **ESP** and the host hard drive.

File	
New	Ctrl+N
Open...	Ctrl+O
Save	Ctrl+S
Save As...	
Print...	Ctrl+P
Import...	
Export...	
Recent File	
Exit	

Import/Export

Import converts the ASCII settings from a text file to **ESP** configuration settings.

Export converts the active **ESP** configuration settings to an ASCII text file.

Model

In the **Model** menu you can select any of the models supported by **ESP**. When you choose a different model, the connection to your present model will be terminated.

To connect to another model, select **New Model**, choose a new model from the **pop-up menu** that appears, and click **OK**.

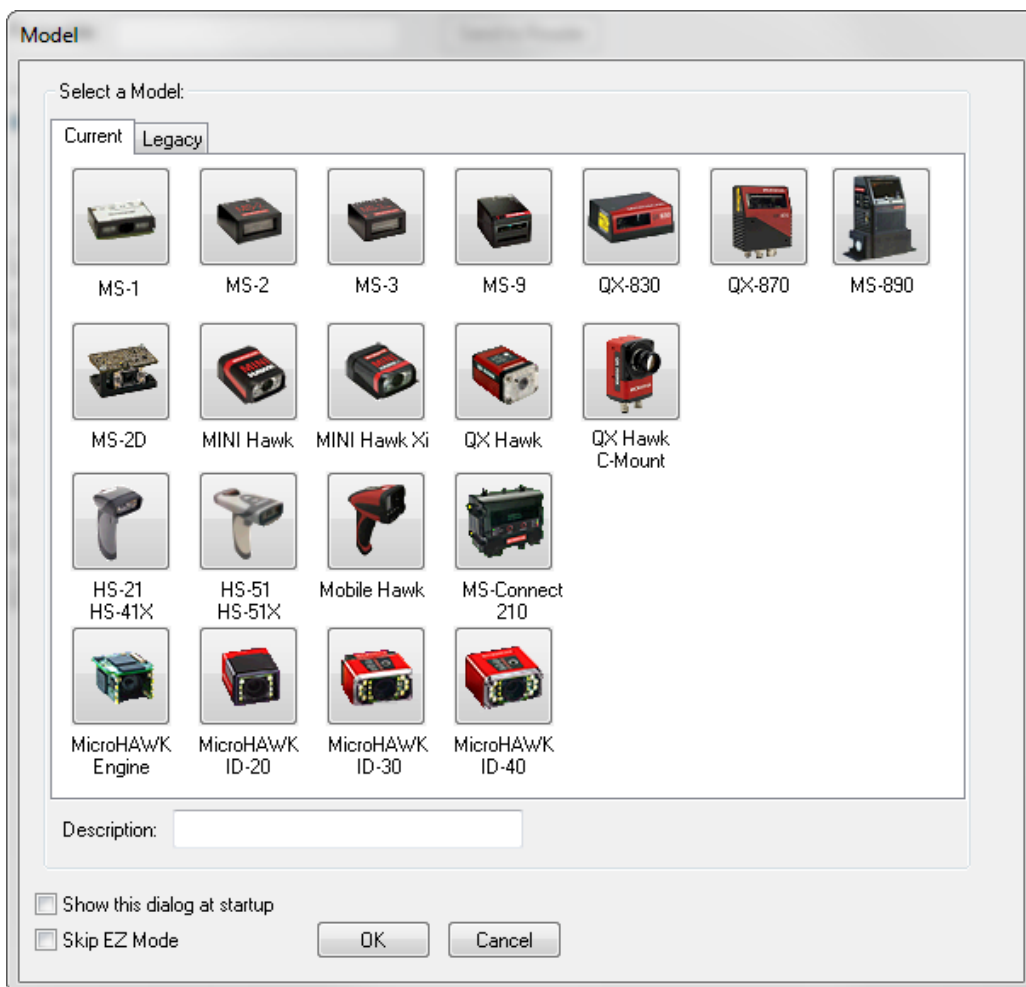

Note: When you save a **.esp** file, you are saving the settings of all models defined in that file.

Options

The **Options** menu allows you to save memos and set up **ESP Preferences**.

Note: Preferences will be saved and loaded into **ESP** whenever **ESP** is opened next, whether or not you save the **ESP** file.

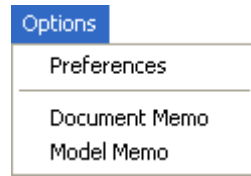

Preferences > General Tab

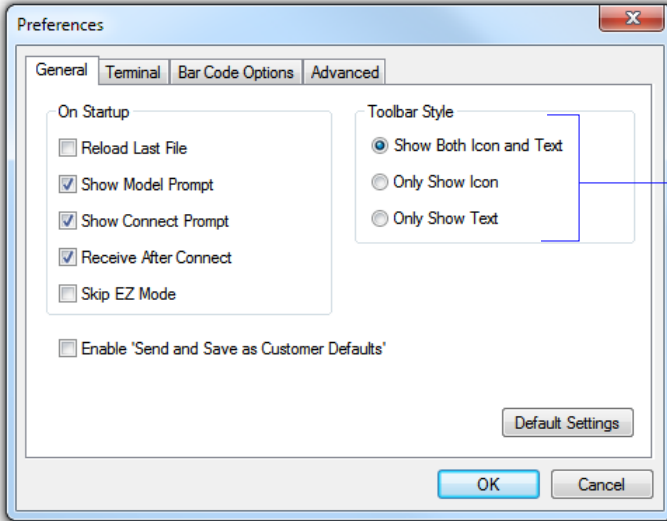

The **Toolbar Style** options allow you to determine how **ESP** will display the mode options in the two rows at the top of the screen.

Reload Last File

At startup, reloads the last file saved to the host computer's hard drive.

Show Model Prompt

At startup, shows the model menu displaying all supported readers.

Show Connect Prompt

At startup, displays the **Would you like to connect to the MicroHAWK ID?** prompt.

Receive After Connect

At startup, loads the reader's settings into **ESP**. (This is not recommended if you want to preserve your **ESP** settings for future use.)

Skip EZ Mode

At startup, skips **EZ Mode** and opens directly in **App Mode**.

Enable 'Send and Save as Customer Defaults'

At startup, enables the **Send and Save as Customer Defaults** option in the **Send/Recv** command.

Preferences > Terminal Tab

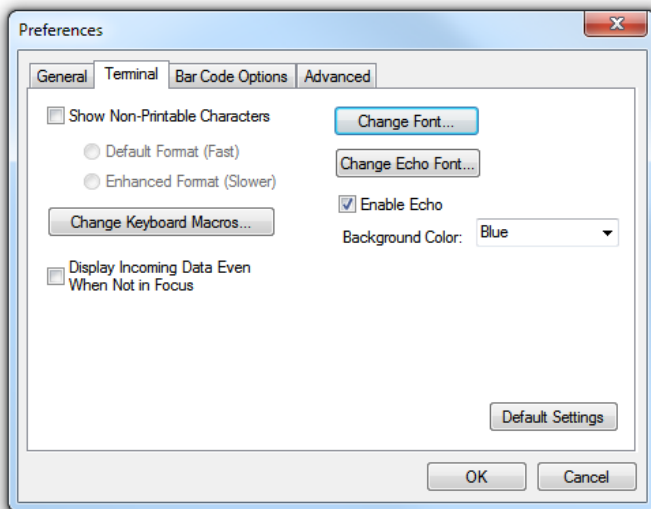

Show Non-Printable Characters

When **Show Non-Printable Characters** is enabled, characters such as “CRLF” will be displayed in the **Terminal** window. When **Enhanced Format** is checked, the characters are displayed with more detailed formatting.

Change Keyboard Macros

Clicking the **Change Keyboard Macros** button brings up the **Function Keys** dialog. In this dialog you can select the desired function key and then enter your macro keystrokes in the associated key map. For example, to make **Ctrl-F2** the keystroke to send a trigger character, select **F2**, then in the **Ctrl** row, enter **<trigger character>** and click **OK**. Then whenever the **Ctrl-F2** keystroke is pressed, the trigger character will start the read cycle.

Note: The **F1** key is reserved for opening **ESP Help** and the **F3** key is reserved for the **Find Next** function.

Change Font

Allows you to modify the font used for decode data received from the reader on the **Terminal** screen.

Change Echo Font

Allows you to modify the font used for command characters typed into the **Terminal** view.

Enable Echo

Allows you to enter command characters in **Terminal**.

Display Incoming Data Even When Not in Focus

When **Display Incoming Data Even When Not in Focus** is enabled, data from the reader will continue to appear in the terminal even when **ESP** is not the top window.

Preferences > Bar Code Options Tab

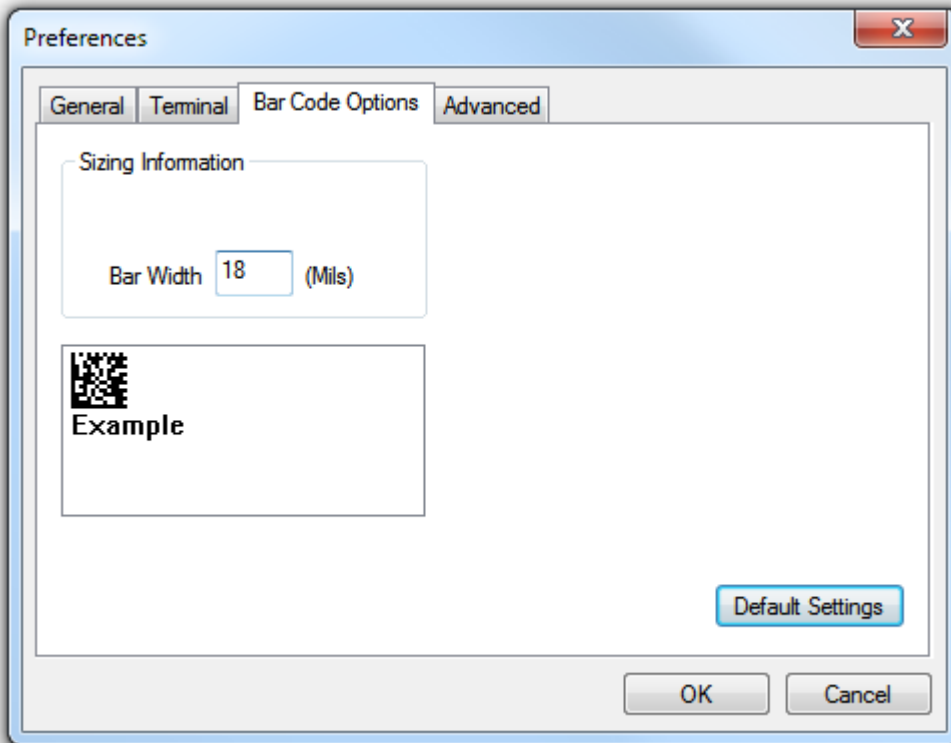

The **Bar Code Options** dialog allows you to set the size of user-created symbols.

Sizing Information

Sets the bar width or module width (in **mils**, or thousandths of an inch) of user-created symbols.

Example: A bar width of 18 is 0.018 inches.

Preferences > Advanced Tab

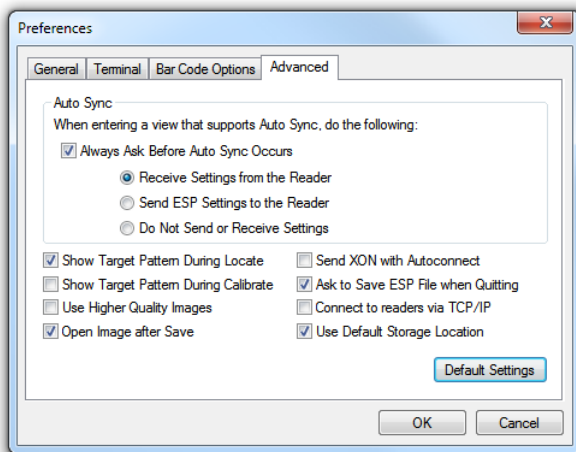

The **Auto Sync** options at the top of the **Advanced** tab allow you to determine whether Auto Sync will be enabled automatically in sections of **ESP** where it is used, or if it will ask you before it enables Auto Sync functions.

Always Ask Before Auto Sync Occurs

If you check this option box, you are then able to determine what specific Auto Sync functions will be enabled. **Receive Settings from the Reader** will automatically send the reader's settings to **ESP** when Auto Sync is enabled. **Send ESP Settings to the Reader** will automatically send all reader configuration settings chosen in **ESP** to the reader. **Do Not Send or Receive Settings** creates a condition in which Auto Sync will not automatically send reader settings to **ESP**, or send **ESP** settings to the reader.

Show Target Pattern During Locate

Allows you to determine whether the blue LED target pattern will be on or off during the **Locate** routine.

Show Target Pattern During Calibrate

Allows you to determine whether the blue LED target pattern will be on or off during the **Calibrate** routine.

Use Higher Quality Images

Sets **ESP** to output images at a higher resolution than standard JPEG format.

Open Image after Save

When **Open Image after Save** is enabled, **ESP** automatically opens saved image captures. Images can be saved from the **Evaluation** tab in the **Camera** view, or by right-clicking an image in any other image capture view and then saving.

Send XON with Autoconnect

Sends an **XON (Begin Transmission)** command to the reader before starting **Autoconnect**.

Preferences > Advanced Tab (cont.)

Ask to Save ESP File when Quitting

When enabled, prompts the user to save a **.esp** file when ending a session.

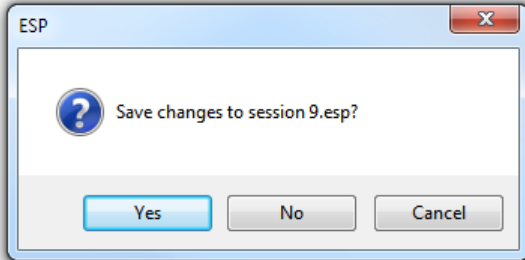

The **.esp** file will be saved in the location of your choice.

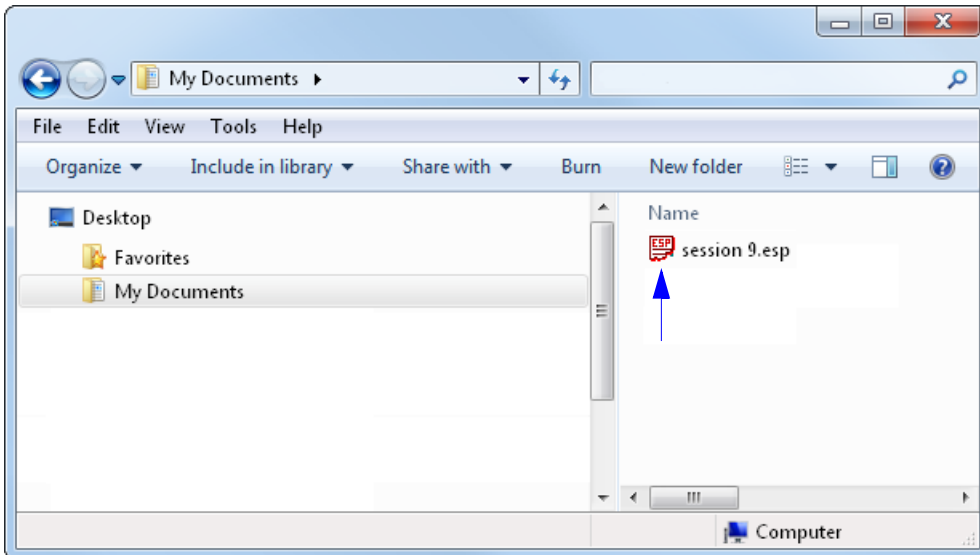

Connect to Readers via TCP/IP

When enabled, shows a **TCP/IP** option on the **Connection Wizard**.

Use Default Storage Location

When enabled, automatically stores data in **ESP's** Application Data folder.

Document Memo

The information you type in the **Document Memo** field will appear in a context-sensitive text box whenever your cursor hovers over the **Document Memo** item on the **Options** menu.

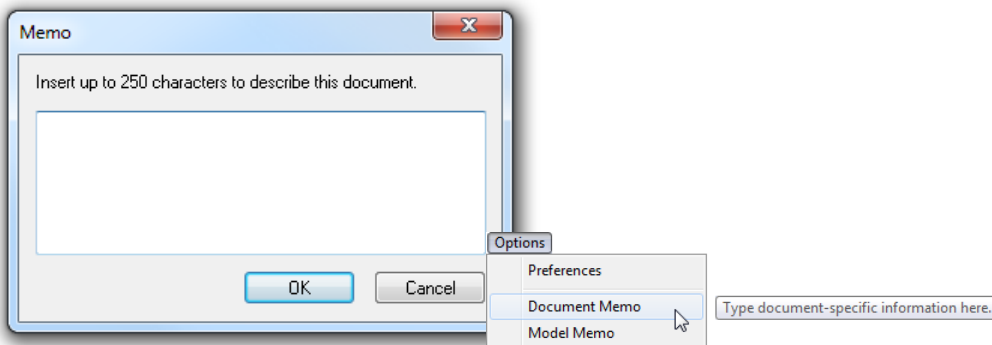

Model Memo

Similar to **Document Memo**, the information you type in the **Model Memo** field will appear in a context-sensitive text box whenever your cursor hovers over the **Model Memo** item on the **Options** menu. Memos created in **Model Memo** are specific to the model enabled when the message was created.

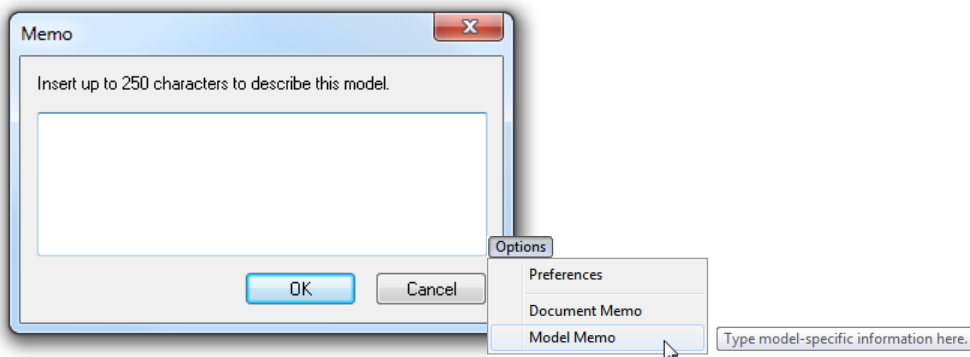

Note: Memos must be saved in a **.esp** file if you want them to be available in your next session. If you do not save your current session, any memos that you have entered during the session will be discarded, and will be unavailable in your next session.

Connect

The **Connect** dropdown menu allows the user to access the **Connection Wizard**, as well as the **Autoconnect** dialog. **Connect** and **Disconnect** can also be performed directly from the dropdown menu without opening a dialog.

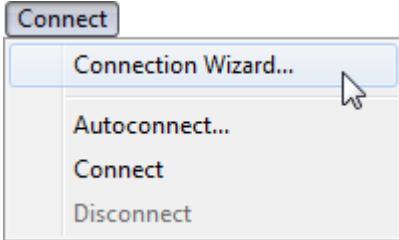

Connection Wizard

To connect using the **Connection Wizard**:

- Click **Connect** on **ESP**'s menu toolbar, and then select **Connection Wizard**.
- Select the communication interface required by your application.
- Configure settings as required by the application, and click **Connect**.

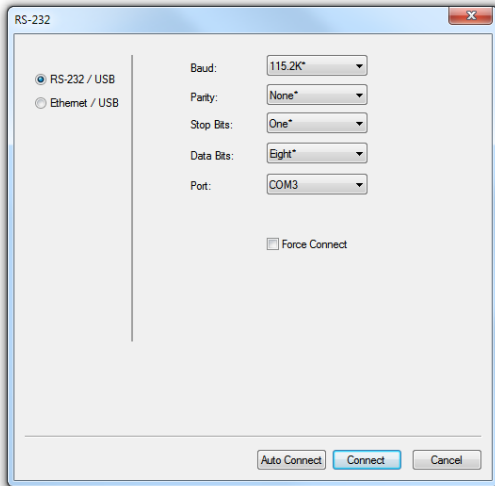

- When a connection is established, the green indicator in the status bar at the bottom right of the screen will be visible.

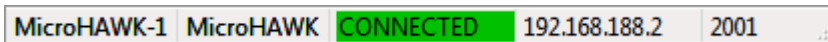

- If your RS-232 connection attempt fails, click the **Auto Connect** button to establish a connection between the MicroHAWK ID and the host.

View

The **View** menu allows you to move quickly between **Parameters**, **Setup**, **Terminal**, and **Utilities** without using the icon buttons on the **App Mode** toolbar. It also allows you to access the **Bar Code Dialog**.

Bar Code Dialog

In the **Bar Code Dialog** you can create symbols by typing the text you wish to encode. This is a useful tool for creating configuration symbols, allowing you to configure your reader by reading the symbols you create.

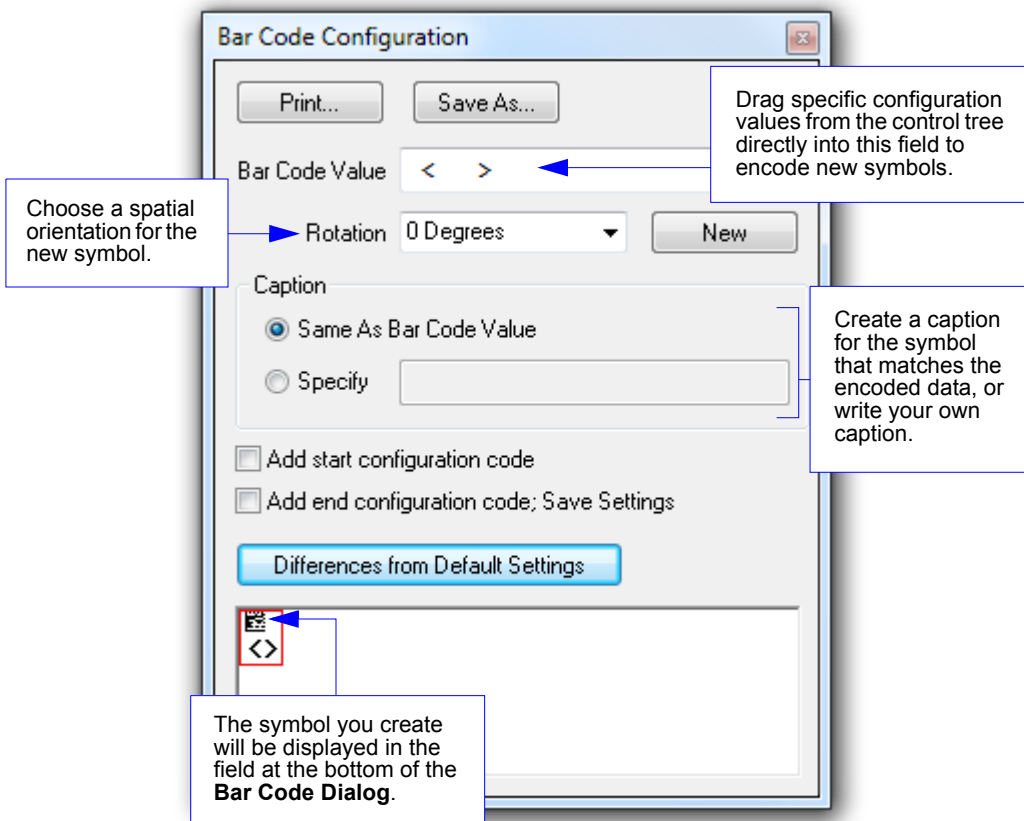

Navigating in ESP

Click the **App Mode** button to change reader settings, or to access the **Utilities**, **Camera**, **Terminal**, or **Output Format** views.

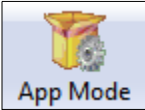

To return to **EZ Mode**, click the **EZ Mode** button.

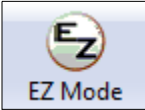

To make changes to configuration settings in the tree controls:

1. **Left-click** on the + to expand menu items.
2. **Double-click** the desired parameter and **single-click** in the selection box to view options.
3. Place your cursor in the selection box, scroll down to the setting you want to change, and **single-click** the setting.

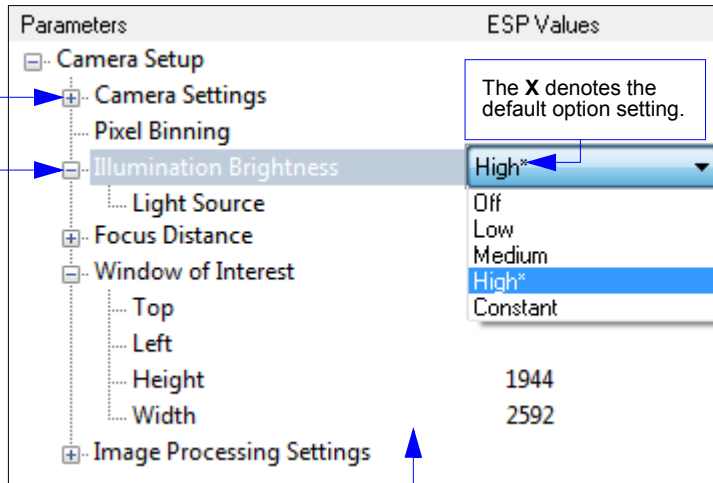

4. **Left-click** again on the open screen to complete the selection.
5. **Right-click** on the open screen and select **Save to Reader** to implement the command in the reader. You can send the command without saving it, or you can send and save the command simultaneously.

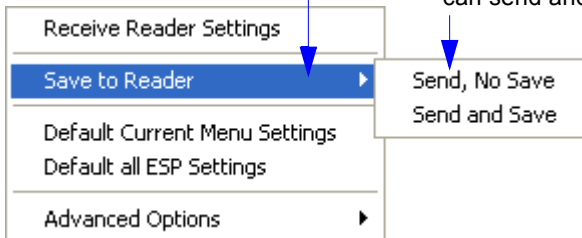

Send/Receive Options

To access **Receive**, **Save**, and **Default** options, click the **Send/Recv** button. You can also access these options by right-clicking in any of the configuration views.



Receiving

From the **Send/Recv** menu, select **Receive Reader Settings**.

Caution: Do not select this option if you do not want to upload the reader's settings. For example, if your **ESP** file has a number of custom settings that you want to maintain and download into the reader, these settings would be lost by choosing **Yes**.

This is useful if you want to receive (upload) the reader's settings and save them as a file for future use. For example, if your reader has settings that you do not want to change, choosing **Yes** would allow you to load those settings to **ESP** and save them in an **ESP** file for later retrieval.

Receiving the reader's settings will also assure that you will not be subsequently saving any unwanted changes that you or someone else has made previously in **ESP**.

Saving

Send, No Save (<A>)

Saves **ESP** settings to current memory.

Send and Save (<Z>)

Activates all changes in current memory *and* saves to the reader for power-on.

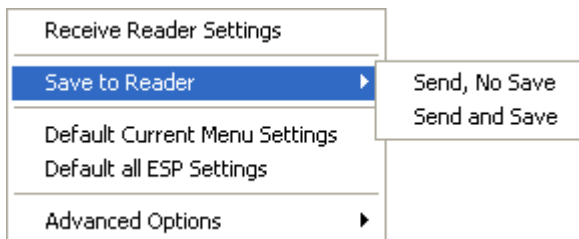

Send and Save as Customer Defaults (<Zc>)

Saves your default settings for quick retrieval.

This option will be visible only if you have checked **Enable 'Send and Save as Customer Defaults'** in **ESP Preferences**.

Defaulting

When you select **Default Current Menu Settings** or **Default all ESP Settings**, you are only defaulting the **ESP** settings.

Advanced Options

Send Current View

This is the same as **Save to Reader** > **Send No Save** except that only the commands in the current configuration tree are sent.

Send Current Command

This is the same as **Send Current View**, except that it saves only the command that is currently selected.

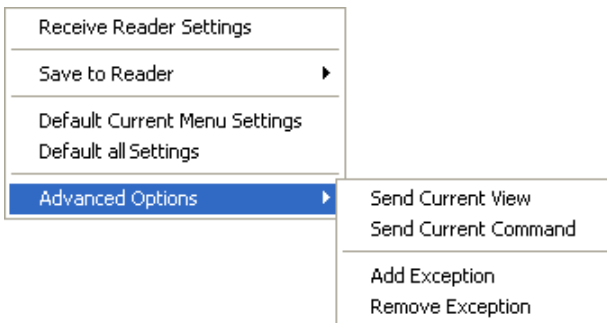

Add/Remove Exception

After you perform a **Receive Reader Settings** command¹ and you click on the **Add Exception** option, you may see a list of serial commands. These are commands that may be in your reader's firmware, but not included in, or different from, your current version of **ESP**.

You can edit these commands by double-clicking on them and changing them as needed.

It is important to note that these commands will be saved to your reader whenever you send a **Save to Reader** command, or an **<A>** or a **<Z>** command.

Also, if there is a corresponding **ESP** menu item, the **ESP Value** column for that item will be blank following a **Receive Reader Settings** command.

1. From the **Send/Recv** button or by right-clicking in any blank section of a tree control view.

3 Communications

Contents

Communications by ESP	3-2
Communications Serial Commands.....	3-3
Host Port Connections	3-4
Host Port Protocol.....	3-5
ACK/NAK Options.....	3-6
Polling Mode Options.....	3-7
Ethernet	3-8
Response Timeout.....	3-14
LRC (Longitudinal Redundancy Check) Status	3-15
Protocol Configuration Examples.....	3-16
Preamble.....	3-17
Postamble	3-18
USB HID/Keyboard.....	3-19
EtherNet/IP Byte Swapping Enabled	3-24
PROFINET.....	3-25
USB Mass Storage Driver.....	3-26
Entering ASCII Characters as Hex Values	3-27

This section explains how to set up communications with a host.

With Microscan's **ESP** (Easy Setup Program), configuration changes can be made in the **ESP** menus and then sent and saved to the reader. The user can also send serial commands to the reader via **ESP**'s **Terminal** window.

Communications by ESP

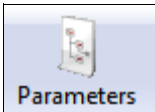

Click the **Parameters** button and then the **Communication** tab.

Parameters	ESP Values
[-] Communications	
[-] RS232	
... Baud Rate	115.2K
... Parity	None
... Stop Bits	One
... Data Bits	Eight
[+] Host Protocol	Point-to-Point
[+] USB HID Report Status	
[+] Ethernet	Enabled
[+] Preamble	Disabled
[+] Postamble	Enabled*
... Postamble Characters	Disabled
... Response Timeout	Enabled*
... LRC Status	Disabled
... Search and Configure Mode	Enabled

To open nested options, **single-click** the **+**.

To change a setting, **double-click** the setting and use your cursor to scroll through the options.

Communications Serial Commands

Host Port Connections	<K100,baud rate,parity,stop bits,data bits>
Ethernet	<K126,status,IP address,subnet,gateway,IP address mode>
Ethernet TCP Ports	<K127,TCP Port 1,TCP Port 2>
Search and Configure Mode	<K128,status,timed window>
EtherNet/IP	<K129,status>
Host Protocol	<K140,protocol,address>
Preamble	<K141,status,preamble characters>
Postamble	<K142,status,postamble characters>
Response Timeout	<K143,response timeout>
LRC Status	<K145,status>
ACK/NAK Options	<K147,RES,REQ,STX,ETX,ACK,NAK>
Polling Mode Options	<K148,RES,REQ,STX,ETX,ACK,NAK>
USB HID/Keyboard	<K149,Microscan Report Enabled,Keyboard Report Enabled,Keyboard Language,USB VCOM Status, UART Status>
EtherNet/IP Byte Swapping Enabled	<K163,status>
PROFINET	<K164,status>
USB Mass Storage Driver	<K900,status>

Host Port Connections

The host port can be configured with RS-232 connections.

The following settings define the basic transmission speeds and digital standards that ensure common formatting.

Baud Rate, Host Port

Usage: Can be used to transfer data faster or to match host port settings.

Definition: The rate at which the reader and host transfer data back and forth.

Serial Cmd: <**K100,baud rate,parity,stop bits,data bits**>

Default: **115.2K**

Options:

0 = 600	1 = 1200	2 = 2400
3 = 4800	4 = 9600	5 = 19.2K
6 = 38.4K	7 = 57.6K	8 = 115.2K
9 = 230K		

Parity, Host Port

Usage: Only changed if necessary to match host setting.

Definition: An error detection routine in which one data bit per character is set to 1 or 0 so that the total number of bits in the data field is either even or odd.

Serial Cmd: <**K100,baud rate,parity,stop bits,data bits**>

Default: **None**

Options: **0 = None** 1 = Even 2 = Odd

Stop Bits, Host Port

Usage: Only changed if necessary to match host setting.

Definition: One or two bits added to the end of each character to indicate the end of the character.

Serial Cmd: <**K100,baud rate,parity,stop bits,data bits**>

Default: **One**

Options: **0 = One** 1 = Two

Data Bits, Host Port

Usage: Only changed if necessary to match host setting.

Definition: One or two bits added to the end of each character to indicate the end of the character.

Serial Cmd: <**K100,baud rate,parity,stop bits,data bits**>

Default: **Eight**

Options: **0 = Seven** **1 = Eight**

Host Port Protocol

- Usage:* In general, the point-to-point protocols will work well in most applications. They require no address and must use RS-232 communications standards.
- Definition:* Protocols define the sequence and format in which information is transferred between the reader and the host.
- Serial Cmd:* <K140,protocol,address>
- Default:* **Point-to-Point**
- Options:* **0 = Point-to-Point**
4 = ACK/NAK
5 = Polling Mode

Note: In all protocol modes, the preamble <K141> and postamble <K142> character strings can be used to frame the decode data, and both are included in calculating the LRC (Longitudinal Redundancy Check).

Point-to-Point (Standard)

- Usage:* Used only with RS-232.
- Definition:* Standard **Point-to-Point** requires no address and sends the data to the host whenever it is available, without a request or handshake from the host.
- Serial Cmd:* <K140,0>

ACK/NAK

- Definition:* See the **ACK/NAK Options** command <K147>.
- Serial Cmd:* <K140,4>

Polling Mode

- Definition:* See the **Polling Mode Options** command <K148>.
- Serial Cmd:* <K140,5>

Poll Address

- Serial Cmd:* <K140,protocol,address>
- Default:* 1
- Options:* 1 to 50
1 = Poll address 0x1C, Select address 0x1D
2 = Poll address 0x1E, Select address 0x1F
...
50 = Poll address 0x7E, Select address 0x7F

ACK/NAK Options

Definition: These parameters take effect for **ACK/NAK <K140,4>** on the main RS-232 port and are completely independent of the **Polling Mode Options <K148>**. The reader always follows the protocol in both directions (to and from the host). There is no option to disable it from either direction.

Serial Cmd: <K147,RES,REQ,STX,ETX,ACK,NAK>

RES-NAK Defaults

RES: (Reset)	00 (disabled)
REQ: (Request)	00 (disabled)
STX: (Start of Text)	00 (disabled)
ETX: (End of Text)	00 (disabled)
ACK: (Acknowledge)	06
NAK: (Negative Acknowledge)	15

The following are general outlines of the **ACK/NAK** protocol. Items that are framed by brackets ([]) can either be disabled or enabled. LRC does not include STX, but it does include preamble, postamble, and ETX.

Symbol Data Output

TX to host: [STX] [preamble] SYMBOL DATA [postamble] [ETX] [LRC]

Response from host: ACK/NAK. Sent when LRC, ETX, postamble, or timeout (waiting for more data) are detected (if REQ is disabled) depending on what is enabled.

Commands from Host to Reader

TX to Reader: [STX] <command> [ETX] [LRC]

Response from Reader: ACK/NAK. Sent when LRC, ETX, or command-ending angle bracket '>' are received, depending on what is enabled.

Command Response from Reader to Host

TX to host: [STX] [preamble] COMMAND RESPONSE DATA [postamble] [ETX] [LRC]

Response from host: ACK/NAK. Sent when LRC, ETX, postamble, command-ending angle bracket '>', or timeout (waiting for more data) are detected, depending on what is enabled.

As with **Polling Mode <K140,5>**, the reader can optionally perform the REQ and RES event sequences in ACK/NAK mode. If the sender does not receive an ACK or NAK, it will send REQ to request such a response (if enabled). When the sender receives an ACK, too many NAKs, or times out (if already enabled), it will send a RES (if enabled) to terminate the transaction.

Note: See **ACK/NAK Data Flow Examples** for sample ACK/NAK communication scenarios.

Polling Mode Options

Definition: These parameters only take effect for **Polling Mode <K140,5>** on the main RS-232 port and are completely independent of the **ACK/NAK Options <K147>**.

The values of protocol characters can be changed, but the protocol events cannot be disabled. The polling mode address is configured in the **<K140>** command (see **Poll Address**).

If RS-232 is enabled, **<K102,0>**, **Polling Mode** will operate as a **Point-to-Point** polling protocol. This is because the RS-232 transmitter is always left on when enabled.

Serial Cmd: **<K148,RES,REQ,STX,ETX,ACK,NAK>**

RES-NAK Defaults

<i>RES: (Reset)</i>	04
<i>REQ: (Request)</i>	05
<i>STX: (Start of Text)</i>	02
<i>ETX: (End of Text)</i>	03
<i>ACK: (Acknowledge)</i>	06
<i>NAK: (Negative Acknowledge)</i>	15

Note: See **Polling Mode Data Flow Examples** for sample **Polling Mode** communication scenarios.

Ethernet

Enables or disables Ethernet connectivity in the reader. This corresponds to the <K126> command. It requires a <Zrdall> to return to default settings.

[-] Ethernet	Enabled
IP Address	192.168.0.100
Subnet	255.255.0.0
Gateway	0.0.0.0
IP Address Mode	Static
[-] TCP Port 1	2001
Symbol Data Output	Enabled
Extra Symbol Information	Enabled
Diagnostics Output	Enabled
External Source Processing Mode	Command
[-] TCP Port 2	2003
Symbol Data Output	Enabled
Extra Symbol Information	Enabled
Diagnostics Output	Enabled
External Source Processing Mode	Command

IP Address

This is the IP address of the reader when it is in Static IP Address Mode.

[-] Ethernet	Enabled
IP Address	192.168.0.100
Subnet	255.255.0.0
Gateway	0.0.0.0
IP Address Mode	Static
[-] TCP Port 1	2001
Symbol Data Output	Enabled
Extra Symbol Information	Enabled
Diagnostics Output	Enabled
External Source Processing Mode	Command
[-] TCP Port 2	2003
Symbol Data Output	Enabled
Extra Symbol Information	Enabled
Diagnostics Output	Enabled
External Source Processing Mode	Command

Subnet

This is the subnet of the reader when it is in Static IP Address Mode.

[-] Ethernet	Enabled
IP Address	192.168.0.100
Subnet	255.255.0.0
Gateway	U.U.U.U
IP Address Mode	Static
[-] TCP Port 1	2001
Symbol Data Output	Enabled
Extra Symbol Information	Enabled
Diagnostics Output	Enabled
External Source Processing Mode	Command
[-] TCP Port 2	2003
Symbol Data Output	Enabled
Extra Symbol Information	Enabled
Diagnostics Output	Enabled
External Source Processing Mode	Command

Gateway

This is the gateway IP address of the reader when it is in Static IP Address Mode.

[-] Ethernet	Enabled
IP Address	192.168.0.100
Subnet	255.255.0.0
Gateway	0.0.0.0
IP Address Mode	Static
[-] TCP Port 1	2001
Symbol Data Output	Enabled
Extra Symbol Information	Enabled
Diagnostics Output	Enabled
External Source Processing Mode	Command
[-] TCP Port 2	2003
Symbol Data Output	Enabled
Extra Symbol Information	Enabled
Diagnostics Output	Enabled
External Source Processing Mode	Command

IP Address Mode

Determines how the reader's IP address will be defined.

[-] Ethernet	Enabled
IP Address	192.168.0.100
Subnet	255.255.0.0
Gateway	0.0.0.0
IP Address Mode	Static*
[-] TCP Port 1	Static*
Symbol Data Output	DHCP
Extra Symbol Information	Enabled
Diagnostics Output	Enabled
External Source Processing Mode	Command
[-] TCP Port 2	2003
Symbol Data Output	Enabled
Extra Symbol Information	Enabled
Diagnostics Output	Enabled
External Source Processing Mode	Command

Static

In **Static Mode**, the reader uses the user-defined IP address entered in ESP. This is the default state for an Ethernet-enabled MicroHAWK.

DHCP

In **DHCP Mode**, the reader automatically acquires the IP address, Subnet, and Gateway addresses from a DHCP or BOOTP server. This is the default state for a USB MicroHAWK.

TCP Port 1

One of two TCP ports for Ethernet communication with the reader. The default setting is **2001**.

[-] Ethernet	Enabled
IP Address	192.168.0.100
Subnet	255.255.0.0
Gateway	0.0.0.0
IP Address Mode	Static
[-] TCP Port 1	2001 1024 - 65535
Symbol Data Output	Enabled
Extra Symbol Information	Enabled
Diagnostics Output	Enabled
External Source Processing Mode	Command
[-] TCP Port 2	2003
Symbol Data Output	Enabled
Extra Symbol Information	Enabled
Diagnostics Output	Enabled
External Source Processing Mode	Command

Symbol Data Output

Enables or disables decoded symbol data output from the reader.

Extra Symbol Information

Enables or disables extra symbol information output from the reader.

Diagnostics Output

Enables or disables diagnostics output from the reader.

External Source Processing Mode

Enables or disables processing of commands or data from sources external to the reader.

Command

Command enables command processing in the reader.

Data

Data enables Ethernet TCP Port 1 as a data source port.

Note: The data path between **in** the source port and **out** the source port is always two-way. Data is copied from source data ports and all those source ports' data is transmitted to the destination port, and from the destination port to the source port.

TCP Port 2

One of two TCP ports for Ethernet communication with the reader. The default setting is **2003**.

[-] Ethernet	Enabled
IP Address	192.168.0.100
Subnet	255.255.0.0
Gateway	0.0.0.0
IP Address Mode	Static
[-] TCP Port 1	2001
Symbol Data Output	Enabled
Extra Symbol Information	Enabled
Diagnostics Output	Enabled
External Source Processing Mode	Command
[-] TCP Port 2	2003
Symbol Data Output	Enabled
Extra Symbol Information	Enabled
Diagnostics Output	Enabled
External Source Processing Mode	Command

Symbol Data Output

Enables or disables decoded symbol data output from the reader.

Extra Symbol Information

Enables or disables extra symbol information output from the reader.

Diagnostics Output

Enables or disables diagnostics output from the reader.

External Source Processing Mode

Enables or disables processing of commands or data from sources external to the reader.

Command

Command enables command processing in the reader.

Data

Data enables Ethernet TCP Port 2 as a data source port.

Note: The data path between **in** the source port and **out** the source port is always two-way. Data is copied from source data ports and all those source ports' data is transmitted to the destination port, and from the destination port to the source port.

Search and Configure Mode

Search and Configure Mode	Enabled*
	Disabled
	Enabled*
	Timed Window

Search and Configure Mode is intended primarily for initial setup of an reader in a network. This parameter controls whether or not the reader will respond to ESP's **Search** function in the Ethernet TCP/IP connect dialog section of the **Connection Wizard**:

Name	IP Address	MAC ID
	10.10.4.132	00:0B:43:0F:6B:6B

After the reader is in full use in an application, you may want the reader to continue to appear in the **Search** response list for future searches. This can help prevent disruption of the system that may occur is ESP were to show only unconfigured units.

Changes to this parameter are saved to NOVRAM and are set to default on power on.

A Reset **<A>** is required for settings to take effect.

Important: Once this setting is Disabled, ESP will only be able to connect to the reader if you know the IP address and enter it in the IP Address field of the Ethernet TCP/IP connect dialog. Search and Configure Mode can be re-enabled by defaulting the reader.

Enabled

When enabled, **Search and Configure Mode** will find the reader and settings can be changed.

Timed Window

When **Timed Window** is selected, Search and Configure Mode will find the reader and settings can be changed, but only 60 seconds from the last reset. After 60 seconds, Search and Configure Mode will be disabled.

Response Timeout

Usage: Only used when a response is required from the host. The reader can be set to wait indefinitely by setting **Response Timeout** to zero.

Definition: The time that the reader will wait before timing out if **ACK**, **NAK**, and **ETX** are enabled, and a host response is expected.

Serial Cmd: **<K143,response timeout>**

Default: **12** (in 1 ms increments)

Options: 0 to 255 (A zero (0) setting causes an indefinite wait.)

LRC (Longitudinal Redundancy Check) Status

Usage: Used when extra data integrity is required.

Definition: An error-checking routine that verifies the accuracy of transmissions. It is the exclusive OR of all characters following the **STX** (start of text) up to and including the **ETX** (end of text). What this means is that the binary representation of all the characters in a transmission are cumulatively added in a column and each resulting odd integer is assigned a 1 and each even integer a 0 (two 1s = 0, two 0s = 0, a 1 and a 0 = 1). The extra LRC character is then appended to the transmission, and the receiver (usually the host) performs the same addition and compares the results.

Serial Cmd: <**K145,status**>

Default: **Disabled**

Options: **0 = Disabled** 1 = Enabled

Protocol Configuration Examples

Point-to-Point (Main Port)

<K100,8,0,1,1> Baud Rate: **115.2K**; Parity: **None**; Stop Bits: **2**; Data Bits: **8**
<K140,0> Point-to-Point
<K102,0> RS-232 enabled

Polling Mode (Main Port)

<K100,4,0,1,1> Baud Rate: **9600**; Parity: **None**; Stop Bits: **2**; Data Bits: **8**
<K140,5,23> Polling Mode; Address: **23**
<K102,0> RS-232 Point-to-Point polling
<K143,30> 30 ms Response Timeout

“User-Defined” Polling Mode (Main Port)

<K100,4,0,1,1> Baud Rate: **9600**; Parity: **None**; Stop Bits: **2**; Data Bits: **8**
<K140,5,12> Polling Mode; Address: **12**
<K148,,08,09,18,0B,0C,0D> Default RES (0x04), REQ=0x08; EOT=0x09; STX=0x18;
ETX=0x0B; ACK=0x0C; NAK=0x0D
<K102,0> RS-232 Point-to-Point polling
<K143,40> 40 ms Response Timeout

ACK/NAK (Main Port)

<K100,9,0,1,1> Baud Rate: **230K**; Parity: **None**; Stop Bits: **2**; Data Bits: **8**
<K140,4> ACK/NAK
<K147,,01,1B,2E,1F> Default RES and REQ (00, disabled); STX=0x01; ETX=0x1B;
ACK=0x2E; NAK=0x1F
<K102,0> RS-232 enabled
<K143,50> 50 ms Response Timeout

Preamble

Preamble Status

- Usage:** Useful for identifying and controlling incoming data. For example, defining the preamble as a carriage return and a line feed causes each decoded message to be displayed on its own line.
- Definition:** Defines a one to four character data string that can be added to the front of the decoded data.
- Serial Cmd:** <**K141,status,preamble character(s)**>
- Default:** **Disabled**
- Options:** **0 = Disabled** 1 = Enabled (within any protocol)

Preamble Characters

- Serial Cmd:** <**K141,status,preamble character(s)**>
- Default:** **^M** corresponds to: **carriage return**.
- Options:** To enter control characters within a serial command, hold down the **Ctrl** key while typing the desired character.

Example: <**K141,1,CNTL-m**> to enter the control character **^M**.

Postamble

Postamble Status

Usage: Useful for identifying and controlling incoming data. For example, defining the postamble as a carriage return and a line feed causes each decoded message to be displayed on its own line.

Definition: Allows the user to enable or disable up to four postamble characters that can be added to the end of the decoded data.

Serial Cmd: <**K142,status,postamble character(s)**>

Default: **Enabled**

Options: 0 = Disabled **1 = Enabled (within any protocol)**

Postamble Characters

Serial Cmd: <**K142,status,postamble character(s)**>

Default: **^M^J** corresponds to: **carriage return/line feed**.

Options: To enter control characters within a serial command, hold down the control key while typing the desired character.

Example: <**K142,1,CNTL-m CNTL-j**> to enter **^M^J**.

USB HID/Keyboard

Definition: These parameters cause the reader to reboot after a **<Z>** or **<A>** command. The data packet is structured for input and output as follows:

Byte 1 = Report Type (Always 1)

Byte 2 = Data Length (Hex Format)

Byte 3 – 64 = Data to Command Processor

Serial Cmd: **<K149, Microscan Report Enabled, Keyboard Report Enabled, Keyboard Language, USB VCOM Status, UART Status>**

Microscan Report Enabled

Serial Cmd: **<K149, Microscan Report Enabled, Keyboard Report Enabled, Keyboard Language, USB VCOM Status, UART Status>**

Default: **0 = Disabled**

Options: **0 = Disabled**

1 = Enabled

Keyboard Report Enabled

Serial Cmd: **<K149, Microscan Report Enabled, Keyboard Report Enabled, Keyboard Language, USB VCOM Status, UART Status>**

Default: **0 = Disabled**

Options: **0 = Disabled**

1 = Enabled

Keyboard Language

Definition: Used by the reader to help identify what keyboard layout to use when the keyboard drive is outputting data. If the unit does not have the keyboard layout assigned to this parameter, then it will default to the **en-US** keyboard layout. On the next page is the list of acceptable languages with predefined keyboard layouts. If they are pre-loaded into the reader's firmware they are shown in bold. All other languages will need to be manually loaded as a keyboard.def file or added to the reader's firmware.

Serial Cmd: **<K149, Microscan Report Enabled, Keyboard Report Enabled, Keyboard Language, USB VCOM Status, UART Status>**

Default: **en-US**

Options: ASCII string, up to 25 characters

Keyboard Languages

Language	Display Name	Loaded into Firmware
af-ZA	Afrikaans - South Africa	No
sq-AL	Albanian - Albania	No
ar-DZ	Arabic - Algeria	No
ar-BH	Arabic - Bahrain	No
ar-EG	Arabic - Egypt	No
ar-IQ	Arabic - Iraq	No
ar-JO	Arabic - Jordan	No
ar-KW	Arabic - Kuwait	No
ar-LB	Arabic - Lebanon	No
ar-LY	Arabic - Libya	No
ar-MA	Arabic - Morocco	No
ar-OM	Arabic - Oman	No
ar-QA	Arabic - Qatar	No
ar-SA	Arabic - Saudi Arabia	No
ar-SY	Arabic - Syria	No
ar-TN	Arabic - Tunisia	No
ar-AE	Arabic - United Arab Emirates	No
ar-YE	Arabic - Yemen	No
hy-AM	Armenian - Armenia	No
Cy-az-AZ	Azeri (Cyrillic) - Azerbaijan	No
Lt-az-AZ	Azeri (Latin) - Azerbaijan	No
eu-ES	Basque - Basque	No
be-BY	Belarusian - Belarus	No
bg-BG	Bulgarian - Bulgaria	No
ca-ES	Catalan - Catalan	No
zh-CN	Chinese - China	No
zh-HK	Chinese - Hong Kong SAR	No
zh-MO	Chinese - Macau SAR	No
zh-SG	Chinese - Singapore	No
zh-TW	Chinese - Taiwan	No
zh-CHS	Chinese (Simplified)	No
zh-CHT	Chinese (Traditional)	No
hr-HR	Croatian - Croatia	No
cs-CZ	Czech - Czech Republic	No
da-DK	Danish - Denmark	No
div-MV	Dhivehi - Maldives	No
nl-BE	Dutch - Belgium	No
nl-NL	Dutch - The Netherlands	No
en-AU	English - Australia	No
en-BZ	English - Belize	No
en-CA	English - Canada	No
en-CB	English - Caribbean	No
en-IE	English - Ireland	No
en-JM	English - Jamaica	No
en-NZ	English - New Zealand	No
en-PH	English - Philippines	No
en-ZA	English - South Africa	No
en-TT	English - Trinidad and Tobago	No
en-GB	English - United Kingdom	No

Keyboard Languages (continued)

en-US	English - United States	Yes
en-ZW	English - Zimbabwe	No
et-EE	Estonian - Estonia	No
fo-FO	Faroese - Faroe Islands	No
fa-IR	Farsi - Iran	No
fi-FI	Finnish - Finland	No
fr-BE	French - Belgium	No
fr-CA	French - Canada	Yes
fr-FR	French - France	No
fr-LU	French - Luxembourg	No
fr-MC	French - Monaco	No
fr-CH	French - Switzerland	No
gl-ES	Galician - Galician	No
ka-GE	Georgian - Georgia	No
de-AT	German - Austria	No
de-DE	German - Germany	No
de-LI	German - Liechtenstein	No
de-LU	German - Luxembourg	No
de-CH	German - Switzerland	No
el-GR	Greek - Greece	No
gu-IN	Gujarati - India	No
he-IL	Hebrew - Israel	No
hi-IN	Hindi - India	No
hu-HU	Hungarian - Hungary	No
is-IS	Icelandic - Iceland	No
id-ID	Indonesian - Indonesia	No
it-IT	Italian - Italy	No
it-CH	Italian - Switzerland	No
ja-JP	Japanese - Japan	No
kn-IN	Kannada - India	No
kk-KZ	Kazakh - Kazakhstan	No
kok-IN	Konkani - India	No
ko-KR	Korean - Korea	No
ky-KZ	Kyrgyz - Kazakhstan	No
lv-LV	Latvian - Latvia	No
lt-LT	Lithuanian - Lithuania	No
mk-MK	Macedonian (FYROM)	No
ms-BN	Malay - Brunei	No
ms-MY	Malay - Malaysia	No
mr-IN	Marathi - India	No
mn-MN	Mongolian - Mongolia	No
nb-NO	Norwegian (Bokmål) - Norway	No
nn-NO	Norwegian (Nynorsk) - Norway	No
pl-PL	Polish - Poland	No
pt-BR	Portuguese - Brazil	No
pt-PT	Portuguese - Portugal	No
pa-IN	Punjabi - India	No
ro-RO	Romanian - Romania	No
ru-RU	Russian - Russia	No
sa-IN	Sanskrit - India	No
Cy-sr-SP	Serbian (Cyrillic) - Serbia	No
Lt-sr-SP	Serbian (Latin) - Serbia	No

Keyboard Languages (continued)

sk-SK	Slovak - Slovakia	No
sl-SI	Slovenian - Slovenia	No
es-AR	Spanish - Argentina	No
es-BO	Spanish - Bolivia	No
es-CL	Spanish - Chile	No
es-CO	Spanish - Colombia	No
es-CR	Spanish - Costa Rica	No
es-DO	Spanish - D.R.	No
es-EC	Spanish - Ecuador	No
es-SV	Spanish - El Salvador	No
es-GT	Spanish - Guatemala	No
es-HN	Spanish - Honduras	No
es-MX	Spanish - Mexico	Yes
es-NI	Spanish - Nicaragua	No
es-PA	Spanish - Panama	No
es-PY	Spanish - Paraguay	No
es-PE	Spanish - Peru	No
es-PR	Spanish - Puerto Rico	No
es-ES	Spanish - Spain	No
es-UY	Spanish - Uruguay	No
es-VE	Spanish - Venezuela	No
sw-KE	Swahili - Kenya	No
sv-FI	Swedish - Finland	No
sv-SE	Swedish - Sweden	No
syr-SY	Syriac - Syria	No
ta-IN	Tamil - India	No
tt-RU	Tatar - Russia	No
te-IN	Telugu - India	No
th-TH	Thai - Thailand	No
tr-TR	Turkish - Turkey	No
uk-UA	Ukrainian - Ukraine	No
ur-PK	Urdu - Pakistan	No
Cy-uz-UZ	Uzbek (Cyrillic) - Uzbekistan	No
Lt-uz-UZ	Uzbek (Latin) - Uzbekistan	No
vi-VN	Vietnamese - Vietnam	No

USB VCOM (Virtual COM) Status

Definition: This command enables the **USB Virtual COM Port Driver** if your reader supports the driver. The reader will reset so the driver can be used.

Serial Cmd: <**K149**,*Microscan Report Enabled,Keyboard Report Enabled,Keyboard Language,USB VCOM Status,UART Status*>

Options: **0 = Disabled (Default for ID-40)**
1 = Enabled (Default for Engine, ID-20, and ID-30)

UART Status

Definition: This command allows the reader to communicate on the reader's **UART** if the reader is UART-capable. The reader will reset so the UART can be used.

Serial Cmd: <**K149**,*Microscan Report Enabled,Keyboard Report Enabled,Keyboard Language,USB VCOM Status,UART Status*>

Options: **0 = Disabled (Default for ID-20)**
1 = Enabled (Default for Engine, ID-30, and ID-40)

EtherNet/IP Byte Swapping Enabled

Definition: Enables or disables EtherNet/IP byte swapping for decode data.

Serial Cmd: <**K163,status**>

Default: **Disabled**

Options: **0 = Disabled**

1 = Enabled

PROFINET

Definition: Enables or disables the PROFINET communications protocol.

Serial Cmd: <**K164,status**>

Default: **Disabled**

Options: **0 = Disabled**
1 = Enabled

USB Mass Storage Driver

Definition: Enables USB MicroHAWK readers to display a Mass Storage device on the host PC.

Serial Cmd: **<K900,status>**

Default: **Disabled**

Options: **0 = Disabled**

1 = Enabled

Entering ASCII Characters as Hex Values

Commands that require ASCII text fields, such as **Preamble** and **Postamble** commands, can be sent to the reader as hex values.

Serial Cmd Format: <**Knnnh,00-FF**>

To enter ASCII fields as hex values (00 to FF), add a lower-case **h** directly after the command's **K** number, and then enter the hex value that corresponds with the desired ASCII character.

Example:

Consider the **Postamble** command:

Serial Cmd: <**K142,status,postamble character(s)**>

Imagine that your application requires the ASCII character **>** to be the postamble in your symbol decode output.

The ASCII characters **<**, **>**, and **,** can only be entered as hex values. So, to make **>** the postamble in your symbol decode output, enter the **Postamble** command as follows:

<K142h,,3E>

Note that the "status" field contains only a **,**. This is because the only field that is being changed is the "postamble character(s)" field. (See **Serial Configuration Command Conventions** for a more detailed explanation of this command shortcut.)

Entering ASCII Characters as Hex Values



4 Calibration

Contents

- Calibration Serial Commands 4-2
- Calibration Overview 4-2
- Calibration Options 4-3
- Calibration by ESP 4-10
- Initiating Calibration 4-12
- Additional Notes about Calibration..... 4-13

This section shows the MicroHAWK ID's calibration options, and explains the different ways that those options can be configured.

Calibration Serial Commands

Calibration Options	<K529,gain,exposure,focus position,symbol type,WOI framing,WOI margin,line scan height,processing>
---------------------	--

Calibration Overview

Calibration is one of the most powerful features of the MicroHAWK ID. The calibration process can be initiated by serial command or in the **ESP** user interface.

When the reader enters calibration, it runs through an optimization cycle that sets the ideal parameters for reading symbols at the highest possible level of performance. Calibration can be specially configured to optimize specific parameters, such as gain, exposure, and symbol type.

Calibration Options

This command specifies the operation of the calibration feature. The default configuration performs calibration on gain and symbol type. The calibration process optimizes the gain setting for the configured exposure.

Gain

- Definition:** When enabled, gain is calibrated to provide the best available image quality and performance.
When disabled, gain is fixed and is not part of the calibration process.
- Serial Cmd:** <**K529,gain,exposure,focus position,symbol type,WOI framing,WOI margin,line scan height,processing**>
- Default:** **Enabled (Decode Required)**
- Options:** 0 = Disabled
1 = Enabled (Decode Required)
2 = Quick Calibrate

Note: If you choose to calibrate the reader by sending a <**@CAL**> command, a decode is also required for the calibration process to be completed successfully.

Disabled

When disabled, gain is fixed and is not part of the calibration process.

Enabled

When enabled, gain is calibrated to provide the best image quality and performance for the symbol present in the field of view. Calibration requires that a decodable symbol be placed in the field of view, as feedback from the symbol decoding process is used to select the best gain setting. If a symbol is not decoded the process will result in a fail condition. Gain is enabled by default.

Quick Calibrate

Quick Calibrate uses the automatic gain control (AGC) feature of the image sensor to adjust the gain value such that the current image falls into a desirable region of the image sensor's sensitivity range, ensuring optimal image luminance. The image sensor converges on the optimal gain value within a few image frames.

Exposure

Definition: Unless the application is static, exposure should be configured based on the application's line speed. The table below is a general guideline for exposure configurations at various line speeds.

Serial Cmd: <K529,gain,**exposure**,focus position,symbol type,WOI framing,WOI margin, line scan height,processing>

Default: **Enabled (Decode Required)**

Options: 0 = Disabled

1 = Enabled (Decode Required)

2 = Quick Calibrate

Note: If you choose to calibrate the reader by sending a <@CAL> command, a decode is also required for the calibration process to be completed successfully.

Note: This table shows guidelines for exposure settings based on various line speeds. The settings shown depend on the reader's optical configuration and on symbol element size.

Exposure	Line Speed
100,000 – 4,000	Static
4,000 – 1,250	5" / sec
1,250 – 700	10" / sec
700 – 500	15" / sec
500 – 400	20" / sec

Disabled

When disabled, exposure is fixed and is not part of the calibration process.

Enabled

When enabled, exposure is calibrated to provide the best image quality and performance for the symbol present in the field of view. Calibration requires that a decodable symbol be placed in the field of view, as feedback from the symbol decoding process is used to select the best exposure setting. If a symbol is not decoded the process will result in a fail condition. Exposure is enabled by default.

Quick Calibrate

Quick Calibrate uses the automatic exposure control feature of the image sensor to adjust the exposure value such that the current image falls into a desirable region of the image sensor's sensitivity range, ensuring optimal image luminance. The image sensor converges on the optimal exposure value within a few image frames.

Focus Position

Definition: The reader's focus position can be configured by entering the target distance value, so focus position can usually be configured without calibration. However, if it is necessary to calibrate the focus distance there are two methods: the standard **Search Method** and a **Quick Focus** method, both of which are defined below.

Serial Cmd: <K529,gain,exposure,**focus position**,symbol type,WOI framing,WOI margin, line scan height,processing>

Default: **Enabled (Decode Required)**

Options: 0 = Disabled
1 = Enabled (Decode Required)
 2 = Quick Calibrate

Disabled

The focus position is fixed and is not part of the calibration process.

Enabled (Search Method)

Focus position is calibrated to provide the best image quality and performance. This method is a simple search algorithm that cycles through focus settings and configures camera settings to try and locate the desired focus as quickly as possible. This is accomplished when a symbol is decoded. Once a focus distance that produces a successful decode has been located, the algorithm fine tunes the search to locate the inside and outside focal distances. The final focus distance is between the inside and outside values. This method may be time-consuming if the focus is not found on the first pass.

Quick Focus

Quick Focus quickly locates the focus setting for an object at the center of the field of view. This is accomplished with minimal image processing, by analyzing a histogram of the image frame. Before performing focus calibration, a value for exposure and gain is determined. The process then steps through the focus range of the system capturing the required number of image frames for each focal position. Then a histogram is performed on each image frame, and the histogram results for each focal position are averaged. When the process is finished, the data is analyzed and the optimal focus position is determined.

Note: This method may not work for all applications. This method is not ideal for very small symbols.

Symbol Type

Serial Cmd: <**K529**,gain,exposure,focus position,**symbol type**,WOI framing,WOI margin,line scan height,processing>

Default: **Enabled**

Options: 0 = Disabled **1 = Enabled**

Disabled

When this feature is disabled, only the current enabled symbologies will be considered during the calibration process.

Enabled

When this feature is enabled, autodiscrimination is in effect during the calibration process. All supported symbologies except PDF417 and Pharmacode will be attempted during calibration. Any new symbologies successfully decoded during calibration will remain enabled at the end of the process. All enabled symbologies will remain enabled. For example, assume that only Code 39 is enabled at the beginning of calibration. If a Code 128 symbol is decoded during calibration, then Code 128 as well as Code 39 will be enabled.

Window of Interest (WOI) Framing

Definition: If WOI Framing is enabled, the camera's Window of Interest will be set to a full size image when calibration begins. Once a symbol is decoded, the camera WOI will be zoomed in both vertically and horizontally (regardless of which WOI mode is enabled) to include the symbol plus an additional margin. This is done to speed up the calibration process. When a successful calibration is complete, the camera WOI will be adjusted according to the mode enabled. Otherwise, the original WOI configuration will be retained.

Serial Cmd: `<K529,gain,exposure,focus position,symbol type,WOI framing,WOI margin, line scan height,processing>`

Default: **Disabled**

Options: **0 = Disabled**
 1 = Row and Column
 2 = Row
 3 = Column
 4 = Straight Line
 5 = Straight Line Framed

If WOI framing is not enabled, the current WOI configuration will be used until a symbol has been decoded. After a symbol is decoded, the WOI is framed exactly as it would be if a WOI framing mode was enabled. When calibration completes, the original WOI configuration is restored.

Disabled

When this feature is disabled, the Window of Interest is not modified after the calibration process is complete.

Row and Column

If the calibration process is successful, the Window of Interest will be modified to frame the symbol as well as an additional margin area around the symbol, determined by the **WOI Margin** parameter.

Row

If the calibration process is successful, the Window of Interest rows will be modified to horizontally frame the symbol, plus an additional margin area around the symbol, determined by the WOI Margin parameter.

Column

If the calibration process is successful, the Window of Interest columns will be modified to vertically frame the symbol, plus an additional margin area around the symbol, determined by the WOI Margin parameter.

Straight Line

This feature is intended for use with linear symbologies. If the calibration process is successful, the orientation of the symbol is determined and the Window of Interest is modified according to the symbol orientation. The scan line orientation is determined to be vertical if the symbol tilt is between 225° and 315°, or between 45° and 135°. Otherwise, the scan line will be horizontal.

If the symbol is vertical, the image column size will be set by the scan height parameter, and will be configured for full row resolution. If the symbol is horizontal, the image row size will be set by the scan height parameter, and will be configured for full column resolution. The scan line will be centered in the middle of the symbol. If the symbol is tilted such that the scan line will not pass completely through the symbol, the scan width will be adjusted to include the entire symbol. Refer to the diagram below:



Straight Line Framed

This parameter is the same as “Straight Line”, except that the Window of Interest will also frame the scan line on the symbol length as well. The scan line includes the symbol plus an additional margin area determined by the WOI Margin parameter.

Window of Interest (WOI) Margin

Definition: Sets the margin size that is applied to the calibrated symbol. This parameter is expressed in number of pixels. If the margin causes the image to exceed the maximum image size, it will be reduced accordingly.

Serial Cmd: <**K529**,gain,exposure,focus position,symbol type,WOI framing,**WOI margin**, line scan height,processing>

Default: **75 (pixels)**

Options: 20 to 1280

Line Scan Height

Definition: This parameter is only used with the Straight Line modes. It sets the scan height of the straight-line image, and it is expressed in number of pixels.

Serial Cmd: <**K529**,gain,exposure,focus position,symbol type,WOI framing,WOI margin, **line scan height**,processing>

Default: **64 (pixels)**

Options: 3 to 1280

Processing

Definition: This setting defines the amount of time and effort the reader will spend attempting to decode a symbol for each parameter configuration.

Serial Cmd: <**K529**,gain,exposure,focus position,symbol type,WOI framing,WOI margin, line scan height,**processing**>

Default: **Medium**

Options: 0 = Low

1 = Medium

2 = High

3 = Definable

Low

The reader will spend a low amount of effort attempting to decode the given symbol for each parameter configuration.

Medium

The reader will spend a medium amount of effort attempting to decode the given symbol for each parameter configuration.

High

The reader will spend a high amount of effort attempting to decode the given symbol for each parameter configuration.

Definable

The processing time for each image frame is defined by **Image Processing Timeout**.

Calibration by ESP

ESP's **Calibration** view incorporates all the functionality of the <K529> (**Calibration Options**) command in a single easy-to-use, intuitive interface. This calibration process allows the user much finer control of individual parameters than the calibration routine in **EZ Mode** or on the **Video** tab.

Before/During Calibration

Before and **After** tabs give the user an authentic representation of the difference in what the reader "sees" before and after the calibration routine.

Exposure, Gain, and Image Quality values are all tracked in real-time during the calibration process.

Gain and Shutter Speed are configurable in the **Calibration** interface.

Determines the amount of time and effort the reader will spend attempting to decode a symbol for each parameter configuration. (**Low, Medium, High, Definable**).

Dropdown menu of **1D** and **2D** symbologies, and a check box for enabling or disabling **Composite** symbologies.

Initiates the calibration routine.

Cancel
Save

Calibrates the calibration process, if necessary.

The **Window of Interest** section of the **Calibration** interface allows the user to make precise adjustments to **WOI Framing**, **WOI Margin** (in pixels), and the scan height of the straight-line image (in pixels).

Beginning calibration...
Processing
Medium*

250 32 8792
Shutter Gain Quality

Gain 32
Shutter Speed 250

Symbology Type
[ECC 200, Code 39]
 Composite Enabled

Window of Interest
WOI Framing Disabled*
WOI Margin 75
Linescan Height 64

After Calibration

The screenshot displays the 'After' calibration results. At the top left, there are two image thumbnails labeled 'Before' and 'After'. The 'After' image shows a significantly sharper barcode. To the right of the images are three vertical indicator bars for 'Shutter' (value 250), 'Gain' (value 38), and 'Quality' (value 8792). Below these is a horizontal progress bar that is fully filled with blue. The interface includes several control panels: 'Capture Settings' with 'Gain' set to 38 and 'Shutter Speed' set to 250; 'Processing' with a dropdown set to 'Medium*'; 'Symbology Type' set to '(ECC 200, Code 39)'; a checked 'Composite Enabled' checkbox; and 'Window of Interest' settings with 'WOI Framing' set to 'Disabled*', 'WOI Margin' set to 75, and 'Linescan Height' set to 64. At the bottom right, there are three buttons: 'Calibrate', 'Cancel', and 'Save'. A callout box points to the 'Save' button.

Before After

250 38 8792

Shutter Gain Quality

The **Shutter**, **Gain**, and **Quality** indicator bars remain stationary at the end of calibration to provide a visual reference for the final values of these four parameters.

Capture Settings

Gain 38

Shutter Speed 250

Processing

Medium*

Symbology Type

(ECC 200, Code 39)

Composite Enabled

Window of Interest

WOI Framing Disabled*

WOI Margin 75

Linescan Height 64

Calibrate

Cancel

Save

Notice the improved image resolution after the calibration process is complete.

The calibration progress bar indicates that the process has been completed.

Saves the optimal configuration parameters determined by calibration results.

Initiating Calibration

Calibration can be initiated by serial command or from the **Calibration** interface in **ESP**. A symbol must be in the reader's field of view during the calibration process.

In **ESP**, the **Calibrate** button starts the calibration routine.

A rectangular button with a light gray background and a thin black border. The word "Calibrate" is centered on the button in a black, sans-serif font.

Note: If you choose to calibrate the reader by sending a **<@CAL>** command, a decode is also required for the calibration process to be completed successfully.

Additional Notes about Calibration

The following conditions apply to the reader's calibration process. Some of these items are noted at various points throughout this section, or in other sections of the reader's documentation.

1. If **Window of Interest Framing** is enabled, the WOI will be set to full frame when calibration begins. If **WOI Framing** is disabled, the current WOI configuration will be used for the **Search Pass**.
2. **Image Processing Mode** will not be altered during calibration.
3. **Thresholding Mode** will be set to **Adaptive** during calibration. At the completion of a successful calibration, the threshold mode will remain set to Adaptive regardless of its previous setting. Otherwise, the value will revert back to its original state. This is so the reader can continue to decode after calibration is finished.
4. If **Symbol Type** is enabled for calibration (**Autodiscriminate**), then **Interleaved 2 of 5 Range Mode Status (Interleaved 2 of 5) <K472>** will be enabled. This allows variable-length Interleaved 2 of 5 symbols to be decoded. If an Interleaved 2 of 5 symbol is decoded during calibration, then code length # 1 will be set to the decoded symbol length at the end of calibration. Otherwise, the symbol lengths will be restored to their original configurations.
5. **Pharmacode** is not calibrated.
6. The symbol size, dimension, and orientation parameters of the **No Symbol / Bad Symbol** and **Symbol Qualification** command **<K718>** will be updated if calibration is successfully completed.
7. All symbol types that were enabled before calibration will still be enabled after calibration. For example, if Data Matrix ECC 200 was enabled before calibration, and the calibration routine was performed on a Code 128 symbol, then after calibration is completed both Data Matrix ECC 200 and Code 128 will be enabled.
8. Calibration does not modify the global **Composite** status **<K453>**. The global Composite status must be configured properly before calibration.
9. If the user requires calibration of a **stacked** symbology **<K482>**, **<K483>**, or **<K484>**, that symbology must be enabled and configured appropriately before calibration.
10. The **Search** process will use the configurable Window of Interest for image captures. However, when the search process is completed, the WOI will be reduced to include only the symbol of interest and some additional boundary area.

5 Read Cycle

Contents

Read Cycle by ESP	5-2
Read Cycle Serial Commands.....	5-3
Read Cycle Setup.....	5-4
Multisymbol.....	5-5
Trigger Mode and Filter Duration.....	5-6
External Trigger Polarity	5-11
Serial Trigger	5-12
Start Trigger Character (Non-Delimited).....	5-13
Stop Trigger Character (Non-Delimited).....	5-14
End of Read Cycle.....	5-15
Capture Mode.....	5-17
Capture Timing	5-22
Image Processing Timeout.....	5-24
Image Storage	5-25
Minimum Good Reads	5-27

After you've established communications and completed basic read rate testing, you will need to address the spatial and timing parameters associated with your application. This section explains those parameters.

Read Cycle by ESP

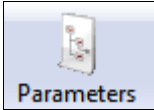

Click the **Parameters** button and then the **Read Cycle** tab.

Parameters	ESP Values
[-] Read Cycle	
[+] Multisymbol	
[-] Trigger	
... Mode	Continuous Read Auto
[+] Trigger Filter Duration	
... External Trigger State	Active Closed
[+] Serial Trigger	
... Decodes Before Output	1
[-] End of Read Cycle	
... Mode	Timeout*
... Read Cycle Timeout	
[+] Capture Mode	
[+] Capture Time	
[+] Store No Read Image	
[+] Image Processing Settings	

Timeout*

Timeout*

New Trigger

Timeout or New Trigger

Last Frame

Last Frame or New Trigger

To open nested options, **single-click** the +.

To change a setting, **double-click** the setting and use your cursor to scroll through the options.

Read Cycle Serial Commands

Trigger Mode/Filter Duration	<K200,trigger mode,leading edge trigger filter,trailing edge trigger filter>
Serial Trigger Character	<K201,serial trigger character>
External Trigger State	<K202,external trigger state>
End of Read Cycle	<K220,end of read cycle mode,read cycle timeout>
Decodes Before Output	<K221,decodes before output>
Multisymbol	<K222,number of symbols,multisymbol separator>
Start Trigger Character	<K229,start character>
Stop Trigger Character	<K230,stop character>
Capture Mode	<K241,capture mode,number of rapid captures,rapid capture mode,number of continuous captures,images per read cycle limit,read cycle history limit>
Capture Time	<K242,time before first capture,time between captures 1 and 2,time between captures 2 and 3,time between captures 3 and 4,time between captures 4 and 5,time between captures 5 and 6,time between captures 6 and 7,time between captures 7 and 8>
Image Storage	<K244,image storage type,image store mode>
Image Processing Timeout	<K245,image processing timeout>

Read Cycle Setup

Setting up read cycle and triggering parameters will involve a series of decisions based on your particular application, as follows:

1. Select the number of symbols to be read in a single cycle. The MicroHAWK ID can read multiple symbols in a single image frame.
2. Decide on the trigger type to be used: if serial, choose a serial character; if external, choose either **Level** or **Edge**.
3. Designate how the read cycle should end (**Timeout**, **New Trigger**, **Last Frame**).
4. Select **Capture Mode**, **Continuous Mode**, or **Rapid Mode**.
5. Select **Number of Captures** (if in **Rapid Capture Mode**).
6. Set the **Time Before First Capture** and **Time Between Captures**, if any.

Note: The capture rate increases as the frame size decreases.

Multisymbol

- Usage:** Multisymbol is commonly used in shipping applications where a shipping symbol contains individual symbols for part number, quantity, etc. This feature allows on trigger to pick up all the symbols.
- Definition:** **Multisymbol** allows the user to define up to 100 symbols that can be read in a single read cycle.
- Conditions:** The following conditions apply:
- Each symbol must be different to be read, unless in **Rapid Capture Mode**, configured for “triggered capture”.
 - The maximum number of characters in a read cycle is 3,000 for all symbols.
 - All No-Read messages are posted at the end of the data string, unless output filtering is enabled.
 - If more than one symbol is within the field of view at the same time, symbol data may not be displayed in the order of appearance.
 - If **Matchcode Type** is set to **Sequential** or if **Trigger** is set to **Continuous Read 1 Output**, the reader will behave as if **Number of Symbols** were set to **1**, regardless of the user-defined configuration.

Number of Symbols

- Definition:** **Number of Symbols** is the number of different symbols that can be read in a single read cycle.
- Serial Cmd:** `<K222,number of symbols, multisymbol separator>`
- Default:** 1
- Options:** 1 to 100

Multisymbol Separator

- Usage:** Used to delimit or separate data fields with a user defined character.
- Definition:** Any valid ASCII character, inserted between each symbol read when Multisymbol is set to any number greater than 1.
- Serial Cmd:** `<K222,number of symbols,multisymbol separator>`
- Default:** , (comma)
- Options:** Any available ASCII character.
- Note:** If No-Read messages are disabled and there are No-Reads occurring, separators will only be inserted between symbol data outputs.

Trigger Mode and Filter Duration

Trigger Mode

Definition: The **Trigger** is the event that initiates a read cycle.

Note: When calibrating the reader or testing read rate, the current trigger setting will be disregarded.

Serial Cmd: <K200,**trigger mode**,*leading edge trigger filter*,*trailing edge trigger filter*>

Default: **Continuous Read**

Options: **0 = Continuous Read**

1 = Continuous Read 1 Output

2 = External Level

3 = External Edge

4 = Serial Data

5 = Serial Data and Edge

6 = Continuous Read Auto

Continuous Read

Usage: **Continuous Read** is useful in testing symbol readability or reader functions. It is not recommended for normal operations.

Definition: In **Continuous Read**, trigger input options are disabled, the reader is always in the read cycle, and it will attempt to decode and transmit every capture. If a single symbol stays within read range for multiple read cycles, its data will be transmitted repeatedly until it leaves the read range.

The reader sends replies to serial commands that require responses when symbol data is transmitted, or read cycle timeout is enabled and a timeout occurs *and* at least one captured image has been processed. Depending on the combination of enabled symbologies, the reader may take longer than the timeout to process a captured image.

Note: When to Output and No-Read options have no affect on **Continuous Read**.

Serial Cmd: <K200,**0**>

Continuous Read 1 Output

Usage: **Continuous Read 1 Output** can be useful in applications where it is not feasible to use a trigger and all succeeding symbols contain different information. It is also effective in applications where the objects are presented by hand.

Definition: In **Continuous Read 1 Output** the reader self-triggers whenever it decodes a new symbol or a timeout occurs.
If **End of Read Cycle** is set to **Timeout** and the symbol doesn't change, the output is repeated at the end of each timeout period. For example, if **Timeout** is set to one second, the reader sends the symbol data immediately and repeats the output at intervals of one second for as long as it continues to capture the symbol.
If **End of Read Cycle** is set to **New Trigger**, the reader will send the current symbol data immediately, *but only once*. A new symbol appearing in the reader's range will be read and sent immediately, provided it is not identical to the previous symbol.

Serial Cmd: <K200,1>

Caution: In automated environments, **Continuous Read 1 Output** is not recommended because there is typically no reliable way to verify that a symbol was missed.

Note: If **Trigger Mode** is set to **Continuous Read 1 Output**, the reader will behave as if **Number of Symbols** were set to 1, regardless of the user-defined configuration.

External Level

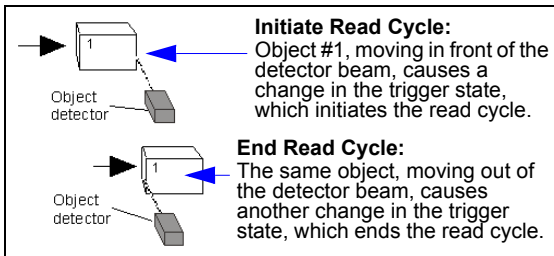

Usage: This mode is effective in an application where the speeds of the conveying apparatus are variable and the time the reader spends reading each object is not predictable. It also allows the user to determine if a No-Read has occurred.

Definition: **External Level** allows the read cycle (active state) to begin when a trigger (change of state) from an external sensing device is received. The read cycle persists until the object moves out of the sensor range and the active trigger state changes again.

Serial Cmd: <K200,2>

Important: **Level** and **Edge** apply to the active logic state (**Active Open** or **Active Closed**) that exists while the object is in a read cycle, between the rising edge and the falling edge. **Rising edge** is the trigger signal associated with the appearance of an object. **Falling edge** is the trigger signal associated with the subsequent disappearance of the object. This applies both to **External Level** and **External Edge**.

External Edge

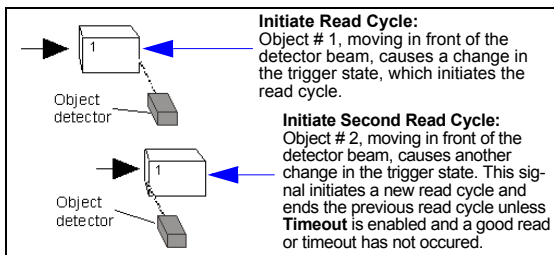

Usage: This mode is highly recommended in any application where conveying speed is constant, or if spacing, object size, or read cycle timeouts are consistent.

Definition: **External Edge**, as with **Level**, allows the read cycle (active state) to begin when a trigger (change of state) from an external sensing device is received. However, the passing of an object out of sensor range does not end the read cycle. The read cycle ends with a good read output, or, depending on the **End of Read Cycle** setting, a timeout or new trigger occurs.

Serial Cmd: <K200,3>

Serial Data

Usage: **Serial Data** is effective in a highly controlled environment where the host knows precisely when the object is in the field of view. It is also useful in determining if a No-Read has occurred.

Definition: In **Serial Data**, the reader accepts an ASCII character from the host or controlling device as a trigger to start a read cycle. A **Serial Data** trigger behaves the same as an **External Edge** trigger.

Serial commands are entered inside angle brackets, as shown here: **<t>**.

Serial Cmd: **<K200,4>**

Note: In **Serial Data**, sending a non-delimited start serial character will start a read cycle; however, a non-delimited stop serial character has no effect.

Serial Data and Edge

Usage: **Serial Data or External Edge** is seldom used but can be useful in an application that primarily uses an external sensing device but occasionally needs to be triggered manually.

Definition: In this mode the reader accepts either a serial ASCII character or an external trigger pulse to start the read cycle.

Serial Cmd: **<K200,5>**

Note: In **Serial Data**, sending a non-delimited start serial character will start a read cycle; however, a non-delimited stop serial character has no effect.

Continuous Read Auto

Definition: Behaves identically to Continuous Read but maintains optimal self-adjusting photometry and focus parameters. As a result, the photometry parameters (Exposure and Gain) in the **<K541>** command as well as the focus parameter in the **<K525>** command are continuously updated with the optimal configuration parameters. In this mode, the illumination does not strobe, but instead is always active, as images are continuously captured. If the **<K525,,,Auto Focus Mode>** field is set to **1**, and if there is a series of no-reads, this mode will self-start a focus pass. **<K525,,, # noreads>** defines how many no-reads must occur before the focus pass will start.

Serial Cmd: **<K200,6>**

Leading Edge Trigger Filter

Usage: Used to ignore spurious triggers when **Trigger Mode** is set to External Edge or External Level.

Definition: To consider a change in state on the trigger input, the level must be stable for the trigger filter duration. In an edge mode, the reader will trigger a read cycle if the active state has been uninterrupted for the entire trigger filter duration. In a level mode, the leading edge is filtered such that on an active edge, the state must be held interrupted for the trigger filter duration before a trigger will occur.

Serial Cmd: <**K200**,trigger mode,leading edge trigger filter,trailing edge trigger filter>

Default: **313** (~10 ms)

Options: 1 to 65535 (Trigger filter range: 32.0 μ s to 2.10 seconds)

Trailing Edge Trigger Filter

Usage: Used to ignore spurious triggers when **Trigger Mode** is set to External Edge or External Level.

Definition: To consider a change in state on the trigger input, the level must be stable for the trigger filter duration. In an edge mode, the reader will trigger a read cycle if the active state has been uninterrupted for the entire trigger filter duration. In a level mode, the trailing edge is filtered such that on the falling edge, the state must be held for the trigger filter duration before the trigger will be deemed inactive.

Serial Cmd: <**K200**,trigger mode,leading edge trigger filter,trailing edge trigger filter>

Default: **313** (~10 ms)

Options: 1 to 65535 (Trigger filter range: 32.0 μ s to 2.10 seconds)

External Trigger Polarity

- Usage:* Allows users to select the trigger polarity that will be used in their application.
- Definition:* Determines the active state of the trigger signal applied to the cable input of the reader.
- Serial Cmd:* <**K202,active state**>
- Default:* **Positive**
- Options:* 0 = Negative **1 = Positive**

Serial Trigger

Usage: Allows the user to define the trigger character and delimiters that start and stop the read cycle.

Definition: A serial trigger is considered an online host command and requires the same command format as all host commands. It must be entered within angle bracket delimiters < > or, in the case of non-delimited triggers, it must define individual start and stop characters.

Serial Trigger Character (Delimited)

Usage: Allows the user to define the trigger character that initiates the read cycle.

Definition: A single ASCII host serial trigger character that initiates the read cycle. A delimited trigger character is one that either starts or ends the read cycle and is enclosed by delimiters such as < >.

Serial Cmd: <**K201,serial trigger character**>

Default: **Space bar**

Options: Any single ASCII character, including control characters, except NUL (0x00 in hex), an existing host command character, or an on-line protocol character. Control characters entered on the command line are displayed in the menu as mnemonic characters.

Note: **Serial Data** or **Serial Data or External Edge** triggering mode must be enabled for **Serial Trigger Character** to take effect.

Start Trigger Character (Non-Delimited)

- Usage:* Useful in applications where different characters are required to start a read cycle.
- Definition:* A single ASCII host serial trigger character that starts the read cycle and is not enclosed by delimiters such as < and >. Non-delimited **Start** characters can be defined and will function according to the trigger event. When defining **Start** trigger characters, the following rules apply:
- In **External Edge** the reader looks only for the **Start** trigger character and ignores any **Stop** trigger character that may be defined.
 - In **External Level** the **Start** trigger character begins the read cycle and the **Stop** trigger character ends it. Note that even after a symbol has been decoded and the symbol data transmitted, the reader remains in **External Level** trigger read cycle until a **Stop** character is received.
 - In **Serial Data or External Edge** trigger mode, either a **Start** trigger character or a hardware trigger can start an edge trigger read cycle.
- Serial Cmd:* <**K229,start character**>
- Default:* **NUL** (00 in hex) (disabled)
- Options:* Two hex digits representing any ASCII character except **XON** and **XOFF**.

Stop Trigger Character (Non-Delimited)

Usage: Useful in applications where different characters are required to end a read cycle.

Definition: A single ASCII host serial trigger character that ends the read cycle and is not enclosed by delimiters such as < and >.

Non-delimited **Stop** characters can be defined and will function according to the trigger event.

When defining **Stop** trigger characters, the following rules apply:

- In **External Edge** the reader looks only for the **Start** trigger character and ignores any **Stop** trigger character that may be defined.
- In **External Level** the **Start** trigger character begins the read cycle and the **Stop** trigger character ends it. Note that even after a symbol has been decoded and the symbol data transmitted, the reader remains in **External Level** trigger read cycle until a **Stop** character is received.
- In **Serial Data or External Edge** trigger mode, either a **Start** trigger character or a hardware trigger can start an edge trigger read cycle.

Serial Cmd: <K230,stop character>

Default: **NUL** (00 in hex) (disabled)

Options: Two hex digits representing an ASCII character.

End of Read Cycle

Definition: The read cycle is the time during which the reader will attempt to capture and decode a symbol. A read cycle can be ended by a timeout, a new trigger, or by the last frame in a capture sequence or a combination of the above.

End of Read Cycle Mode

Note: When operating in Continuous Read or Continuous Read 1 Output, the reader is always in the read cycle.

Serial Cmd: <K220,end of read cycle,read cycle timeout>

Default: **Timeout**

Options: **0 = Timeout**
 1 = New Trigger
 2 = Timeout or new Trigger
 3 = Last Frame
 4 = Last Frame or New Trigger

Timeout

Usage: Typically used with **Serial Data or External Edge** and **Continuous Read 1 Output**.

It is effective in highly controlled applications when the maximum length of time between objects can be predicted. It assures that a read cycle ends before the next symbol appears, giving the system extra time to decode and transmit the data to the host.

Definition: **Timeout** ends the read cycle, causing the reader to stop reading symbols and send the symbol data or No-Read message when the time set in **Timeout** elapses (times out), *if* **When to Output** is set to **End of Read Cycle**.

If in **Continuous Read 1 Output**, a timeout initiates a new read cycle and allows the same symbol to be read again.

With **External Edge**, **Serial Data**, or **Serial Data or External Edge** enabled, a timeout ends the read cycle and symbol data or a No-Read message is sent to the host.

With **External Level** enabled, the read cycle does not end until the falling edge trigger occurs or a timeout occurs. The next read cycle does not begin until the next rising edge trigger.

New Trigger

Usage: **New Trigger** is an effective way to end a read cycle when objects move past the reader at irregular intervals (not timing-dependent).

Definition: **New Trigger** ends the current read cycle and initiates a new one when a new trigger occurs. **New Trigger** refers only to a rising edge trigger. With **External Edge**, **Serial Data**, or **Serial Data or External Edge** enabled, an edge or serial trigger ends a read cycle and initiates the next read cycle. In the case of **External Level**, a falling edge trigger ends the read cycle but the next read cycle does not begin until the occurrence of the next rising edge trigger.

Timeout or New Trigger

Usage: Useful in applications that require an alternative way to end the read cycle. For example, if an assembly line should stop completely or the intervals between objects are highly irregular.

Definition: **Timeout or New Trigger** is identical to **Timeout** except that a timeout or a new trigger (whichever occurs first) ends the read cycle.

Last Frame

Usage: Useful in applications in which the number of captures needed can be defined but the timeout duration varies.

Definition: **Last Frame** only applies to **Rapid Capture Mode**.

Last Frame or New Trigger

Usage: Useful in applications in which line speeds are irregular and a new labelled object could appear before the last frame in a **Rapid Capture** sequence.

Definition: **Last Frame or New Trigger** is identical to **New Trigger** except that a new trigger or last frame (whichever occurs first) ends the read cycle.

Read Cycle Timeout

Definition: **Read Cycle Timeout** is the duration of the read cycle.

Serial Cmd: <K220,end of read cycle,read cycle timeout>

Default: **200** (x10 ms)

Options: 1 to 65535

Capture Mode

Definition: **Capture Mode** relates to the way that images are captured and processed.

Serial Cmd: <K241,capture mode,number of captures,rapid capture mode,number of continuous captures,images per read cycle limit,read cycle history>

Default: **Continuous Capture**

Options: 0 = Rapid Capture 1 = **Continuous Capture**

Rapid Capture

Definition: In a rapid capture mode, one or multiple captures (as many as 32) can be taken at an interval specified by the time-between-captures parameter. In this mode, the only limiting time factor is integration and transfer timing.

Continuous Capture

Usage: **Continuous Capture** is useful in applications with slower line speeds or where symbol spacing may be random or not time-dependent.

Definition: In **Continuous Capture Mode**, image captures are taken throughout the read cycle in a multi-buffered format (see diagram below). The reader begins processing the first captured image at the same time that it captures the second image. Captures will continue occurring throughout the read cycle until an end condition occurs, such as a timeout, a new trigger, the last frame in a capture sequence, or a combination of the above.

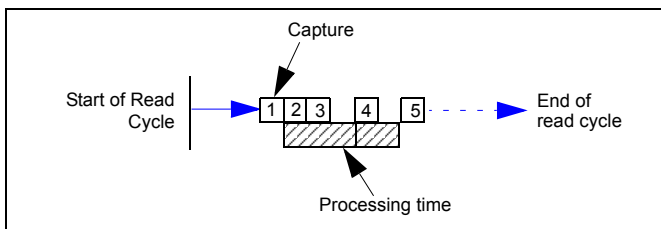

Number of Captures

Usage: **Number of Captures** is used to specify the number of captures to be processed in **Rapid Capture Mode**.

Definition: Sets the total number of captures that are processed during a read cycle in **Rapid Capture Mode**. This feature is used in conjunction with **Capture Timing** parameters to specify the capture sequence of a rapid capture read cycle.

Serial Cmd: <K241,capture mode,number of captures,rapid capture mode,number of continuous captures,images per read cycle limit,read cycle history>

Default: 1

Options: 1 to 255

Note: The range of maximum number of captures is dynamic. This range is dependent on the maximum image size in the system. A full-size image (1280 x 1024) reduces the maximum number of images to **6**. The smaller the image size, the greater the maximum number of captures. Once the image size is reduced to small enough dimensions, the maximum number of captures will be capped at **64**.

If a user enters a maximum capture value greater than that allowed, the value will be limited to the number of system images. This command also affects the number of stored images allowed in the system. If the maximum number of captures is selected, the number of stored images allowed will be **0**.

Rapid Capture Mode

Definition: In **Rapid Capture Mode**, one or multiple captures (as many as 32) can be taken at an interval specified by the time-between-captures parameter. In this mode, the only limiting time factor is integration and transfer timing.

Serial Cmd: <K241,capture mode,number of captures,rapid capture mode,number of continuous captures,images per read cycle limit,read cycle history>

Default: **Timed Capture**

Options: **0 = Timed Capture** 1 = Triggered Capture

Timed Capture

Usage: **Timed Rapid Capture** is useful in fast-moving applications in which symbols are only in the field of view for a short time and precise timing is required.

Definition: In **Timed Rapid Capture**, decoding occurs independent of and simultaneous with capturing, thus allowing precise timing or no delay at all between captures.

Also, consecutive captures are regarded as the same symbol if the output data is the same.

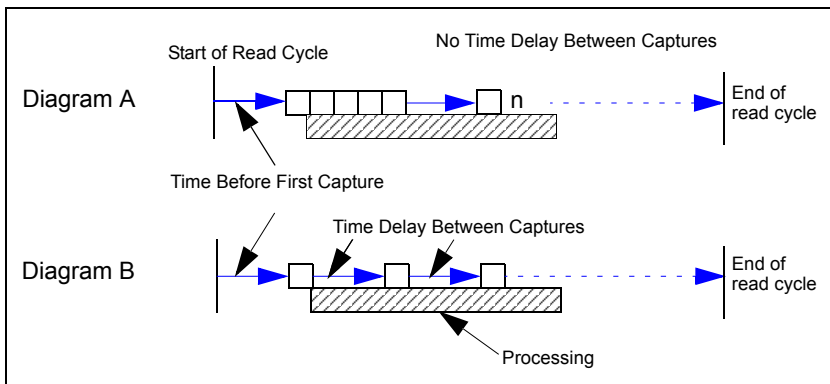

Triggered Capture

Usage: Useful in applications where each decode must be treated as a discrete event, regardless of symbol data.

Definition: The first trigger event starts the read cycle, and subsequent triggers will continue until the predetermined **Number of Captures** is met, or until the predetermined **End of Read Cycle** condition is met-- whichever occurs first.

Note: If **End of Read Cycle** is set for **New Trigger** and the read cycle qualifications have not been met, the read cycle will only end *once it receives the first trigger after reaching the predetermined **Number of Captures** setting.*

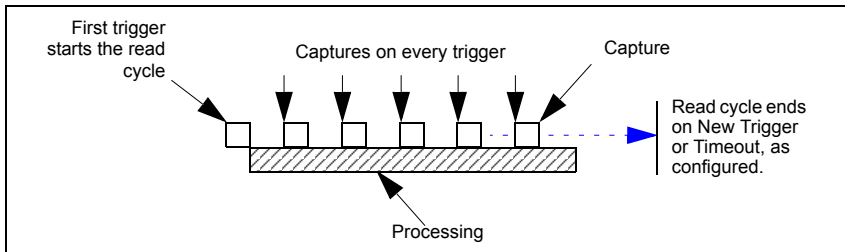

Number of Continuous Captures

Definition: Specifies the number of captures to process in Continuous Capture mode.

Serial Cmd: <**K241**,capture mode,number of captures,rapid capture mode,**number of continuous captures**,images per read cycle limit,read cycle history>

Default: 2

Options: 1 and 255

Images per Read Cycle Limit

Definition: Specifies the number of captures to process in a read cycle.

Serial Cmd: <**K241**,capture mode,number of captures,rapid capture mode,number of continuous captures,**images per read cycle limit**,read cycle history>

Default: 10

Options: 3 and 255

Read Cycle History

Definition: Specifies the number of images that can be stored in read cycle history.

Serial Cmd: <**K241**,capture mode,number of captures,rapid capture mode,number of continuous captures,**images per read cycle limit**,read cycle history>

Default: 10

Options: 0 and 255

Capture Timing

Note: Capture Timing applies only to **Rapid Capture Mode**.

Time Before First Capture

Usage: In almost any moving line application, a time delay is needed to ensure that a symbol will be in the reader's field of view at the beginning of the capture sequence.

Definition: **Time Before First Capture** in a moving line application is the time between an external trigger event and the occurrence of the first capture.

Serial Cmd: <K242,time before 1st capture,time between capture 1 and capture 2,,,,,,,time between capture 7 and capture 8>

Default: 0

Options: 0 to 65535 (2.097 seconds, in 32 μ S increments)

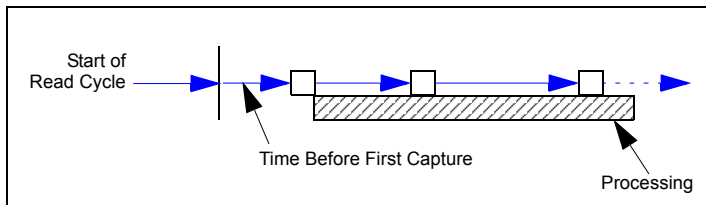

Time Between Captures

Usage: This is useful in applications where more than one symbol can appear during a single read cycle (multisymbol), or where line speeds are slow enough that captured frames might overlap or miss a symbol.

Definition: A time delay can be inserted between individual frame captures in **Rapid Capture Mode**.

Serial Cmd: <K242,time before 1st capture,time between captures [time 1,time 2,...time7]

Entering 0s will result in no time between captures.

Entering a different value in each field will vary the time delays accordingly.

Note: You must enter time values along with comma separators for each field you want to change. If you omit fields, or enter only commas, the fields will remain as previously set.

Important: If the reader is configured to capture more than 8 images, the last (or 8th) delay value will be repeated for the remaining captures.

Default: 0

Options: 0 to 65535 (2.097 seconds, in 32 μ S increments)

Note: Number of Captures and number of frame delays (**Time Between Captures**) must be the same.

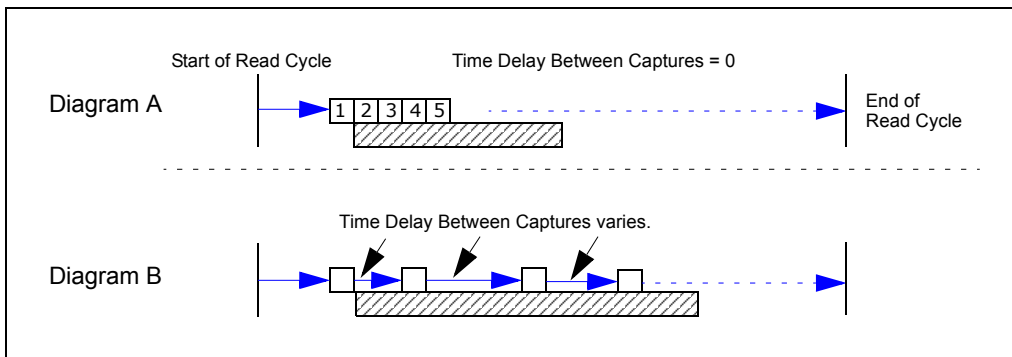

Image Processing Timeout

Usage: Useful in higher speed applications where image processing time is long enough that not all captures have an opportunity to be processed.

Definition: Specifies the maximum amount of time to process a captured image. When the timeout expires, the image processing is aborted. This timeout works in both **Rapid Capture** and **Continuous Capture** modes, as well as with the Configuration Database.

Serial Cmd: **<K245,image processing timeout>**

Default: **5000 ms (5 sec.)**

Options: 1 to 65535 (in 1 ms increments)

Notes:

- The timeout period does not include capture time.
- If a timeout occurs during processing and no symbols in the field of view have been decoded, the image will be recorded as a No-Read. For this reason, a longer timeout should be tried to ensure that the symbol is decoded successfully.

Image Storage

Image Storage Type

Definition: Allows the user to store images from separate read cycles and to retrieve them later. The number of available slots for storage depends on the mode of operation. If the reader is in **Rapid Capture Mode**, the number of images that can be stored is equivalent to the maximum number of the rapid count (the current rapid count setting). If the reader is in **Continuous Capture Mode**, a number of images equivalent to the maximum number of the rapid count minus 3.

Serial Cmd: <K244,image storage type,image storage mode>

Default: Disabled/Clear

Options: 0 = Disabled/Clear 1 = Store on No-Read

Disabled/Clear

Upon selection of this option, all saved images will be cleared and the reader will not store images for later viewing.

Store on No-Read

This option will cause the reader to store an image upon exiting the read cycle for retrieval at a later time. If multiple captures are present during the duration of a read cycle, the stored image will be the last image processed for that read cycle. This image is stored in RAM and can be retrieved as long as power is cycled to the reader, and as long as the reader has not been reset via a reset/save sequence. Other commands that can initialize storage in RAM are ones that change capture modes or put the reader in a test capture mode.

Image Storage Mode

Serial Cmd: <K244,image storage type,image storage mode>

Default: First Mode

Options: 0 = First Mode 1 = Last Mode

First Mode

This mode allows the reader to store images until the available image memory has been filled. At that point the reader will stop saving additional images. In this mode, you will always have the first image captured, because the saving process stops once memory has been filled.

Last Mode

In this mode, image storage continues after available memory limits are reached. The oldest image in memory is overwritten, so you will always have the most recent stored image.

Image Storage Example

The following example assumes that the reader is in a rapid capture mode of 3 captures.

Number of Symbols: 1
Frame # 1: No-Read
Frame # 2: No-Read
Frame # 3: Good Read, Symbol # 1
Read Cycle Result: Good Read
Stored Frame: None

Number of Symbols: 1
Frame # 1: No-Read
Frame # 2: No-Read
Frame # 3: No-Read
Read Cycle Result: No-Read
Stored Frame: Frame # 3

Number of Symbols: 2
Frame # 1: No-Read
Frame # 2: No-Read
Frame # 3: Good Read, Symbol # 1
Read Cycle Result: No-Read
Stored Frame: Frame # 2

Minimum Good Reads

- Definition:* This value specifies the number of times a symbol needs to be read to qualify as a good read.
- Serial Cmd:* <K221,*minimum good reads*>
- Default:* 1
- Options:* 1 to 255



6 Symbologies

Contents

Symbologies by ESP	6-2
Symbologies Serial Commands	6-3
Data Matrix	6-4
Aztec	6-6
QR Code	6-7
Micro QR Code.....	6-8
Code 39.....	6-9
Code 128/EAN 128	6-12
BC412	6-15
Interleaved 2 of 5.....	6-16
Code 93.....	6-19
Codabar.....	6-20
UPC/EAN	6-23
Pharmacode	6-27
Postal Symbologies.....	6-29
GS1 DataBar	6-34
PDF417	6-36
MicroPDF417	6-37
Composite	6-38
DotCode	6-39

This section describes the various symbol types that can be decoded by the MicroHAWK ID.

Symbologies by ESP

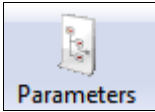

Click the **Parameters** button and then the **Symbologies** tab.

To change a setting, **double-click** the setting and use your cursor to scroll through the options.

Parameters	ESP Values
[-] Symbologies	
[-] 2D Symbologies	
[+] Data Matrix	
QR Code	Enabled
Micro QR Code	Enabled
Aztec Code	Disabled
[-] DotCode	Disabled
Rotation Mode	No Rotation* ▼
No Rotation*	No Rotation*
Low Rotation	Low Rotation
Omni Directional	Omni Directional
Disabled	Disabled
[+] 1D Symbologies	
[+] Stacked Symbologies	
[+] Composite	
Symbology ID	Disabled
Damaged Symbol Status	Disabled
Linear Security Level	Aggressive

To open nested options, **single-click** the +.

Symbologies Serial Commands

Composite	<K453,symbology status,separator status,separator character>
Aztec	<K458,status>
Micro QR Code	<K459,status>
Postal Symbologies	<K460,postal symbology type,POSTNET status,PLANET status,USPS4CB status>
Code 39	<K470,status,check character status,check character output status, large intercharacter gap,fixed symbol length status, fixed symbol length,full ASCII set>
Codabar	<K471,status,start/stop match,start/stop output,large intercharacter gap,fixed symbol length status,symbol length,check character type,check character output>
Interleaved 2 of 5	<K472,status,check character status,check character output status, symbol length #1, symbol length #2, guard bar status, range mode status>
UPC/EAN	<K473,UPC status,EAN status,supplemental status,separator status, separator character,supplemental type,format UPC-E as UPC-A>
Code 128/EAN 128	<K474,status,fixed symbol length status,fixed symbol length,EAN 128 status,output format,application record separator status,application record separator character,application record brackets,application record padding>
Code 93	<K475,status,fixed symbol length status,symbol length>
PDF417	<K476,status,unused,fixed symbol length status,symbol length>
Pharmacode	<K477,status,fixed bar count status,fixed bar count,minimum bar count,bar width mode,direction,fixed threshold value>
Data Matrix	<K479,ECC 200 status, ECC 000 status,ECC 050 status, ECC 080 status,ECC 100 status,ECC 140 status,ECC 120 status,ECC 130 status>
QR Code	<K480,status>
BC412	<K481,status,check character output,fixed symbol length status, fixed symbol length>
DataBar-14	<K482,status>
DataBar Limited	<K483,status>
DataBar Expanded	<K484,status,fixed symbol length status,fixed symbol length>
MicroPDF417	<K485,status,[unused],fixed symbol length status,fixed symbol length>
DotCode	<K497,status,rotation mode>

Data Matrix

Usage: Very useful where information needs to be packed into a small area, and/or where symbols need to be applied directly to the substrate with laser etching, chemical etching, dot peen, or other methods.

Definition: Data Matrix is a type of Matrix symbology and has subsets ECC 000 - ECC 200. ECC 200 symbols have an even number of rows and an even number of columns. Most of the symbols are square with sizes from 10x10 to 144x144. Some symbols, however, are rectangular, with sizes from 8x18 to 16x48. All ECC 200 symbols can be recognized by the upper right corner module being light (binary 0) instead of dark.

ECC 200

Definition: When enabled, will decode ECC 200 Data Matrix symbols.

Serial Cmd: <**K479,ECC 200 status,ECC 000 status,ECC 050 status,ECC 080 status,ECC 100 status,ECC 140 status,ECC 120 status,ECC 130 status**>

Default: **Enabled**

Note: This is the only symbol type enabled by default.

Options: 0 = Disabled **1 = Enabled**

ECC 000

Definition: When enabled, will decode ECC 000 symbols.

Serial Cmd: <**K479,ECC 200 status,ECC 000 status,ECC 050 status,ECC 080 status,ECC 100 status,ECC 140 status,ECC 120 status,ECC 130 status**>

Default: **Disabled**

Options: **0 = Disabled** 1 = Enabled

ECC 050

Definition: When enabled, will decode ECC 050 symbols.

Serial Cmd: <**K479,ECC 200 status,ECC 000 status,ECC 050 status,ECC 080 status,ECC 100 status,ECC 140 status,ECC 120 status,ECC 130 status**>

Default: **Disabled**

Options: **0 = Disabled** 1 = Enabled

ECC 080

Definition: When enabled, will decode ECC 080 symbols.

Serial Cmd: <**K479**,ECC 200 status,ECC 000 status,ECC 050 status,**ECC 080 status**,
ECC 100 status,ECC 140 status,ECC 120 status,ECC 130 status>

Default: **Disabled**

Options: **0 = Disabled** 1 = Enabled

ECC 100

Definition: When enabled, will decode ECC 100 symbols.

Serial Cmd: <**K479**,ECC 200 status,ECC 000 status,ECC 050 status,ECC 080 status,
ECC 100 status,ECC 140 status,ECC 120 status,ECC 130 status>

Default: **Disabled**

Options: **0 = Disabled** 1 = Enabled

ECC 140

Definition: When enabled, will decode ECC 140 symbols.

Serial Cmd: <**K479**,ECC 200 status,ECC 000 status,ECC 050 status,ECC 080 status,
ECC 100 status,**ECC 140 status**,ECC 120 status,ECC 130 status>

Default: **Disabled**

Options: **0 = Disabled** 1 = Enabled

ECC 120

Definition: When enabled, will decode ECC 120 symbols.

Serial Cmd: <**K479**,ECC 200 status,ECC 000 status,ECC 050 status,ECC 080 status,
ECC 100 status,ECC 140 status,**ECC 120 status**,ECC 130 status>

Default: **Disabled**

Options: **0 = Disabled** 1 = Enabled

ECC 130

Definition: When enabled, will decode ECC 130 symbols.

Serial Cmd: <**K479**,ECC 200 status,ECC 000 status,ECC 050 status,ECC 080 status,
ECC 100 status,ECC 140 status,ECC 120 status,**ECC 130 status**>

Default: **Disabled**

Options: **0 = Disabled** 1 = Enabled

Aztec

Usage: Used in document imaging, railway ticket validation, and some postal applications.

Definition: A 2D matrix symbology built on a square grid with a square “bull’s-eye” pattern at the center. **Aztec** can encode up to 3,832 numeric or 3,067 alphabetical characters, or 1,914 bytes of data.

The level of Reed-Solomon error correction used with Aztec is configurable, from 5% to 95% of the total data region. The recommended error correction level is 23% of symbol capacity plus codewords.

Serial Cmd: <**K458,status**>

Default: **Disabled**

Options: **0 = Disabled** 1 = Enabled

QR Code

Usage: Widely implemented in the automotive industry in Japan and throughout their worldwide supply chain.

Definition: QR Code is capable of handling numeric, alphanumeric, and byte data as well as kanji and kana characters. Up to 7,366 characters (numeric data) can be encoded using this symbol. Therefore, less space is required to encode the same amount of data in a QR Code symbol than in a conventional symbol, lowering the cost of labelling.

Three Position Detection Patterns in the symbol make omnidirectional, ultra-fast reading possible.

QR Code has error protection capability. Data can often be restored even if a part of the symbol has become dirty or damaged.

Serial Cmd: **<K480,status>**

Default: **Disabled**

Options: **0 = Disabled** 1 = Enabled

Micro QR Code

Usage: Used in various applications that require higher data density than that provided by standard QR Code. Some application examples are automotive inventory, vehicle ID, and mobile phone URL encodation.

Definition: **Micro QR Code** is a 2D matrix symbology that comes in 4 different symbol sizes, the largest capable of encoding 35 numeric characters.

Serial Cmd: **<K459,status>**

Default: **Disabled**

Options: **0 = Disabled** 1 = Enabled

Code 39

- Usage:** **Code 39** is considered the standard for non-retail 1D symbology.
- Definition:** An alphanumeric symbology with unique start/stop code patterns, composed of 9 black and white elements per character, of which 3 are wide.
- Serial Cmd:** *<K470,status,check character status,check character output status,large intercharacter gap,fixed symbol length status,fixed symbol length,full ASCII set>*
- Default:** **Enabled**
- Options:** 0 = Disabled 1 = **Enabled**

Check Character Status (Code 39)

- Serial Cmd:** *<K470,status,check character status,check character output status,large intercharacter gap,fixed symbol length status,fixed symbol length,full ASCII set>*
- Default:** **Disabled**
- Options:** 0 = **Disabled** 1 = Enabled

Check Character Output Status (Code 39)

- Usage:** **Check Character Output Status**, added to the symbol, provides additional data security.
- Definition:** When enabled, the check character character is read and compared along with the symbol data. When disabled, symbol data is sent without the check character.
- Note:** With **Check Character Output Status** and an **External** or **Serial** trigger option enabled, an invalid check character calculation will cause a No-Read message to be transmitted at the end of the read cycle.
- Serial Cmd:** *<K470,status,check character status,check character output status,large intercharacter gap,fixed symbol length status,fixed symbol length,full ASCII set>*
- Default:** **Disabled**
- Options:** 0 = **Disabled** 1 = Enabled

Large Intercharacter Gap (Code 39)

Usage: **Large Intercharacter Gap** is helpful for reading symbols that are printed out of specification.

Definition: When enabled, the reader can read symbols with gaps between symbol characters that exceed three times (3x) the narrow element width.

Serial Cmd: <**K470**,status,check character status,check character output status,**large intercharacter gap**,fixed symbol length status,fixed symbol length,full ASCII set>

Default: **Disabled**

Options: **0 = Disabled** 1 = Enabled

Fixed Symbol Length Status (Code 39)

Definition: When enabled, the reader will check the symbol length against the symbol length field. If disabled, any length will be considered valid.

Serial Cmd: <**K470**,status,check character status,check character output status,**large intercharacter gap**,**fixed symbol length status**,fixed symbol length,full ASCII set>

Default: **Disabled**

Options: **0 = Disabled** 1 = Enabled

Fixed Symbol Length (Code 39)

Usage: **Fixed Symbol Length** helps prevent truncations and increases data integrity by ensuring that only one symbol length will be accepted.

Definition: Specifies the exact number of characters that the reader will recognize (this does not include start and stop and check character characters). The reader ignores any symbology that does not match the specified length.

Serial Cmd: <**K470**,status,check character status,check character output status,**large intercharacter gap**,fixed symbol length status,**fixed symbol length**,full ASCII set>

Default: **10**

Options: 1 to 64

Full ASCII Set (Code 39)

- Usage:** Must be enabled when reading characters outside the standard character set (0-9, A-Z, etc.)
The user must know in advance whether or not to use the **Full ASCII Set** option. Since **Full ASCII Set** requires two code words to encode one character, it is less efficient.
- Definition:** Standard Code 39 encodes 43 characters; zero through nine, capital “A” through capital “Z”, minus symbol, plus symbol, forward slash, space, decimal point, dollar sign, and percent symbol. When **Full ASCII Set** is enabled, the reader can read the full ASCII character set, from 0 to 255.
- Serial Cmd:** <**K470**,status,check character status,check character output status,large intercharacter gap,fixed symbol length status,fixed symbol length,**full ASCII set**>
- Default:** **Disabled**
- Options:** **0 = Disabled** 1 = Enabled

Code 128/EAN 128

- Usage:** **Code 128** is a smaller symbology useful in applications with tight spots and high security needs.
- Definition:** A very dense alphanumeric symbology. It encodes all 128 ASCII characters, it is continuous, has variable length, and uses multiple element widths measured edge to edge.
- Serial Cmd:** *<K474,status,fixed symbol length status,fixed symbol length,EAN 128 status,output format,application record separator status,application record separator character,application record brackets,application record padding>*
- Default:** **Enabled**
- Options:** 0 = Disabled 1 = **Enabled**

Fixed Symbol Length Status (Code 128/EAN 128)

- Definition:** When enabled, the reader will check the symbol length against the symbol length field. If disabled, any length will be considered a valid symbol.
- Serial Cmd:** *<K474,status,fixed symbol length status,fixed symbol length,EAN 128 status,output format,application record separator status,application record separator character,application record brackets,application record padding>*
- Default:** **Disabled**
- Options:** 0 = **Disabled** 1 = Enabled

Fixed Symbol Length (Code 128/EAN 128)

- Usage:** **Fixed Symbol Length** helps prevent truncations and increases data integrity by ensuring that only one symbol length will be accepted.
- Definition:** This specifies the exact number of characters that the reader will recognize (this does not include start, stop, and check character characters). The reader ignores any symbol not having the specified length.
- Serial Cmd:** *<K474,status,fixed symbol length status,fixed symbol length,EAN 128 status,output format,application record separator status,application record separator character,application record brackets,application record padding>*
- Default:** **10**
- Options:** 1 to 64

EAN 128 Status (Code 128/EAN 128)

Definition: When this field is disabled, the reader will not check any Code 128 labels for conformance to EAN requirements, or perform any special formatting. When enabled, the reader can read symbols with or without a function 1 character in the first position. If a symbol has a function 1 character in the first position, it must conform to EAN format. Symbols that conform to EAN format will also be subject to the special output formatting options available in this command.

Note: Code 128 status must be enabled for EAN status to be active.

If EAN status is required, the reader will only decode symbols that have a function 1 character in the first position and that conform to EAN format. All symbols read will be subject to the special output formatting options available in this command.

Note: Code 128 status must be enabled for EAN status to be active.

Serial Cmd: <**K474**,*status, fixed symbol length status, fixed symbol length, EAN 128 status, output format, application record separator status, application record separator character, application record brackets, application record padding*>

Default: **Disabled**

Options: **0 = Disabled** 1 = Enabled 2 = Required

Output Format (Code 128/EAN 128)

Definition: In **Standard**, the reader will not apply special EAN output formatting options.

In **Application**, the reader will apply the special EAN output formatting options to decoded EAN-conforming symbols.

Serial Cmd: <**K474**,*status, fixed symbol length status, fixed symbol length, EAN 128 status, output format, application record separator status, application record separator character, application record brackets, application record padding*>

Default: **Standard**

Options: **0 = Standard** 1 = Application

Application Record Separator Status (Code 128/EAN 128)

Definition: When enabled, an EAN separator will be inserted into the output between fields whenever an EAN-conforming symbol is decoded and EAN output formatting applies.

Serial Cmd: <**K474**,*status, fixed symbol length status, fixed symbol length, EAN 128 status, output format, application record separator status, application record separator character, application record brackets, application record padding*>

Default: **Disabled**

Options: **0 = Disabled** 1 = Enabled

Application Record Separator Character (Code 128/EAN 128)

Definition: This is an ASCII character that serves as an EAN separator in formatted EAN output.

Serial Cmd: <**K474**,*status, fixed symbol length status, fixed symbol length, EAN 128 status, output format, application record separator status, **application record separator character**, application record brackets, application record padding*>

Default: ,

Options: Any ASCII character (7 bit)

Application Record Brackets (Code 128/EAN 128)

Definition: If an EAN-conforming symbol is decoded and EAN formatting applies, this feature places bracket characters around the application identifiers in the formatted output.

Serial Cmd: <**K474**,*status, fixed symbol length status, fixed symbol length, EAN 128 status, output format, application record separator status, application record separator character, **application record brackets**, application record padding*>

Default: **Disabled**

Options: **0 = Disabled** 1 = Enabled

Application Record Padding (Code 128/EAN 128)

Definition: This feature causes the reader to pad variable-length application fields with leading zeroes. This is not done for the last field of a symbol.

Serial Cmd: <**K474**,*status, fixed symbol length status, fixed symbol length, EAN 128 status, output format, application record separator status, application record separator character, application record brackets, **application record padding***>

Default: **Enabled**

Options: **0 = Disabled** **1 = Enabled**

BC412

- Usage:** Widely used in semiconductor manufacturing. Particularly useful where speed, accuracy, and ease of printing are required.
- Definition:** BC412 (Binary Code 412), a proprietary IBM symbology since 1988, is an alphanumeric symbol with a set of 35 characters, each encoded by a set of 4 bars in 12 module positions. All bars have a single width; it is the presence (1) or absence (0) of bars in each of the twelve module positions that make BC412 binary.
This symbology is also bi-directional and self-clocking, with a start character and a stop character.
- Serial Cmd:** <**K481**,*status*,*check character output*,*fixed symbol length status*,*fixed symbol length*>
- Default:** **Disabled**
- Options:** **0 = Disabled** 1 = Enabled

Check Character Output (BC412)

- Usage:** **Check Character Output**, added to the symbol, provides additional security.
- Definition:** When enabled, the check character character is read and compared along with the symbol data. When disabled, symbol data is sent without the check character.
- Serial Cmd:** <**K481**,*status*,**check character output**,*fixed symbol length status*,*fixed symbol length*>
- Default:** **Disabled**
- Options:** **0 = Disabled** 1 = Enabled

Fixed Symbol Length Status (BC412)

- Definition:** When enabled, the reader will check the symbol length against the symbol length field. If disabled, any length will be considered valid.
- Serial Cmd:** <**K481**,*status*,*check character output*,**fixed symbol length status**,*fixed symbol length*>
- Default:** **Disabled**
- Options:** **0 = Disabled** 1 = Enabled

Fixed Symbol Length (BC412)

- Definition:** When enabled, the check character character is read and compared along with the symbol data. When disabled, symbol data is sent without the check character.
- Serial Cmd:** <**K481**,*status*,*check character output*,*fixed symbol length status*,**fixed symbol length**>
- Default:** **10**
- Options:** 1 to 64

Interleaved 2 of 5

Usage: I-2/5 has been popular because it is the most dense symbology for printing numeric characters less than 10 characters in length; however, Microscan does not recommend this symbology for any new applications because of inherent problems such as truncation.

Definition: A dense, continuous, self-checking, numeric symbology. Characters are paired together so that each character has five elements, two wide and three narrow, representing numbers 0 through 9, with the bars representing the first character and the interleaved spaces representing the second character. (A check character is highly recommended).

Important: You must set Symbol Length in order to decode I-2/5 symbols, unless **Range Mode** is enabled.

Serial Cmd: <**K472,status,check character status,check character output status,symbol length #1,symbol length #2,guard bar status,range mode status**>

Default: **Enabled**

Options: 0 = Disabled 1 = **Enabled**

Check Character Status (Interleaved 2 of 5)

Usage: This option is not typically used, but it can be enabled for additional security in applications where the host requires redundant check character verification.

Definition: An error correcting routine in which the check character character is added.

Serial Cmd: <**K472,status,check character status,check character output status,symbol length #1,symbol length #2,guard bar status,range mode status**>

Default: **Disabled**

Options: 0 = **Disabled** 1 = Enabled

Check Character Output Status (Interleaved 2 of 5)

Definition: When enabled, a check character character is sent along with the symbol data for added data security.

Serial Cmd: <**K472,status,check character status,check character output status,symbol length #1,symbol length #2,guard bar status,range mode status**>

Default: **Disabled**

Options: 0 = **Disabled** 1 = Enabled

Symbol Length #1 (Interleaved 2 of 5)

- Usage:** Useful in applications where 1 2/5 symbols of a specific length are required.
- Definition:** The **Symbol Length # 1** field is one of two fields against which the decoded symbol is compared before accepting it as valid or rejecting it.
- Serial Cmd:** <K472,status,check character status,check character output,**symbol length #1,symbol length #2,guard bar status,range mode status**>
- Default:** 16
- Options:** 0 to 64, even only
- Important:** If **Range Mode** is disabled, the length of the symbol must match either **Symbol Length # 1** or **Symbol Length # 2** to be considered a valid symbol.
- If **Range Mode** is enabled, **Symbol Length # 1** and **Symbol Length # 2** form a range into which the length of the symbol must fall to be considered valid.

Symbol Length #2 (Interleaved 2 of 5)

- Usage:** Useful in applications where 1 2/5 symbols of a specific length are required.
- Definition:** The **Symbol Length # 2** field is one of two fields against which the decoded symbol is compared before accepting it as valid or rejecting it.
- Serial Cmd:** <K472,status,check character status,check character output,**symbol length #1,symbol length #2,guard bar status,range mode status**>
- Default:** 6
- Options:** 0 to 64, even only
- Important:** If **Range Mode** is disabled, the length of the symbol must match either **Symbol Length # 2** or **Symbol Length # 1** to be considered a valid symbol.
- If **Range Mode** is enabled, **Symbol Length # 2** and **Symbol Length # 1** form a range into which the length of the symbol must fall to be considered valid.

Guard Bar Status (Interleaved 2 of 5)

Note: Whenever **Guard Bar** is enabled, the presence of guard bars (also called “bearer bars”) is required for decoding to take place.

Usage: Useful when I-2/5 multisymbols are enabled to prevent false data output. This typically occurs with highly tilted or skewed symbols.

Definition: A guard bar is a heavy bar, at least twice the width of the wide bar, surrounding the printed I-2/5 symbol and helping to prevent false reads.

Serial Cmd: <K472,status,check character status,check character output,symbol length #1,symbol length #2,guard bar status,range mode status>

Default: Disabled

Options: 0 = Disabled 1 = Enabled

Range Mode Status (Interleaved 2 of 5)

Usage: Useful in applications where I 2/5 symbols of a specific length are required.

Definition: When **Range Mode** is disabled, the reader checks the value of the symbol length against the values set in **Symbol Length # 1** and **Symbol Length # 2**. If the symbol length does not match either of the preset values, then it is rejected as invalid.

When **Range Mode** is enabled, **Symbol Length # 1** and **Symbol Length # 2** are combined to form a range of valid symbol lengths. Any symbol length that does not fall into this range is rejected as an invalid symbol. Either of the preset symbol length values in the **Symbol Length # 1** and **Symbol Length # 2** fields can form the start or end of the range.

Serial Cmd: <K472,status,check character status,check character output,symbol length #1,symbol length #2,guard bar status,range mode status>

Default: Enabled

Options: 0 = Disabled 1 = Enabled

Code 93

- Usage:** Sometimes used in clinical applications.
- Definition:** Code 93 is a variable-length, continuous symbology employing four element widths. Each Code 93 character has nine modules that may be either black or white. Each character contains three bars and three spaces.
- Serial Cmd:** **<K475,status,fixed symbol length status,symbol length>**
- Default:** **Disabled**
- Options:** **0 = Disabled** 1 = Enabled

Fixed Symbol Length Status (Code 93)

- Definition:** When disabled, the reader will accept any Code 93 symbol provided is doesn't exceed the system's maximum capabilities.
When enabled, the reader will reject any Code 93 symbol that doesn't match the fixed symbol length.
- Serial Cmd:** **<K475,status,fixed symbol length status,symbol length>**
- Default:** **Disabled**
- Options:** **0 = Disabled** 1 = Enabled

Symbol Length (Code 93)

- Definition:** This is the symbol length value against which all Code 93 symbols will be compared.
- Serial Cmd:** **<K475,status,fixed symbol length status,symbol length>**
- Default:** **10**
- Options:** 1 to 64

Codabar

Usage: Used in photo-finishing and library applications. Previously used in medical applications, but not typically used in newer medical applications.

Definition: Codabar is a 16-bit character set (0 through 9, and the characters \$, :, /, ., +, and -) with start/stop codes and at least two distinctly different bar widths.

Serial Cmd: <K471,status,start/stop match,start/stop output,large intercharacter gap,fixed symbol length status,symbol length,check character type,check character output>

Default: Disabled

Options: 0 = Disabled 1 = Enabled

Start/Stop Match (Codabar)

Definition: When disabled, the reader will decode Codabar symbols whether or not the start and stop characters are the same.

When enabled, the reader will not decode Codabar symbols unless the start and stop characters are the same.

Serial Cmd: <K471,status,start/stop match,start/stop output,large intercharacter gap,fixed symbol length status,symbol length,check character type,check character output>

Default: Enabled

Options: 0 = Disabled 1 = Enabled

Start/Stop Output (Codabar)

Definition: When disabled, the start and stop characters will *not* be present in the data output of the decoded symbol.

When enabled, the start and stop characters *will* be present in the data output of the decoded symbol.

Note: Because the start and stop characters are included as part of the data, the characters must be included as part of the length in a fixed length mode of operation.

Serial Cmd: <K471,status,start/stop match,start/stop output,large intercharacter gap,fixed symbol length status,symbol length,check character type,check character output>

Default: Enabled

Options: 0 = Disabled 1 = Enabled

Large Intercharacter Gap (Codabar)

Definition: When disabled, the spaces between characters, or the “intercharacter gap”, are ignored during the decode process.

Note: If the intercharacter space is large enough to be considered a margin, the symbol will not decode, regardless of this parameter’s setting.

Serial Cmd: <**K471**,status,start/stop match,start/stop output,**large intercharacter gap**,fixed symbol length status,symbol length,check character type,check character output>

Default: **Disabled**

Options: **0 = Disabled** 1 = Enabled

Fixed Symbol Length Status (Codabar)

Definition: When disabled, the reader will accept any Codabar symbol provided it doesn’t exceed the system’s maximum capabilities.

When enabled, the reader will reject any Codabar symbol that doesn’t match the fixed length.

Serial Cmd: <**K471**,status,start/stop match,start/stop output,large intercharacter gap,**fixed symbol length status**,symbol length,check character type,check character output>

Default: **Disabled**

Options: **0 = Disabled** 1 = Enabled

Symbol Length (Codabar)

Definition: This is the value against which all Codabar symbol lengths will be compared.

Serial Cmd: <**K471**,status,start/stop match,start/stop output,large intercharacter gap,fixed symbol length status,**symbol length**,check character type,check character output>

Default: **10**

Options: 1 to 64

Check Character Type (Codabar)

Definition: When disabled, the reader will not perform any character checking calculations on decoded Codabar symbols.

When set to **Mod 16**, the reader will perform a modulus 16 check character calculation on the symbol. If the symbol does not pass this calculation, it will not be decoded.

When set to **NW7**, The reader will perform an NW7 modulus 11 check character calculation on the symbol. If the symbol does not pass this calculation, it will not be decoded.

When set to **Both**, the reader will perform both the Mod 16 and NW7 modulus 11 check character calculations on the symbol. If the symbol does not pass either calculation, it will not be decoded.

Serial Cmd: <K471,status,start/stop match,start/stop output,large intercharacter gap,fixed symbol length status,symbol length,**check character type**,check character output>

Default: Disabled

Options: 0 = Disabled 1 = Mod 16 2 = NW7 (Mod 11)
3 = Mod 16 and NW7

Check Character Output (Codabar)

Definition: When this field is disabled and a check character calculation is enabled, the reader will strip the verified check character from the symbol data output. This condition must be accounted for if a fixed length is also being used.

When enabled, the reader will output the check character as part of the symbol data. This condition must be accounted for if a fixed length is also being used.

Serial Cmd: <K471,status,start/stop match,start/stop output,large intercharacter gap,fixed symbol length status,symbol length,check character type,**check character output**>

Default: Disabled

Options: 0 = Disabled 1 = Enabled

UPC/EAN

Usage: Used primarily in point-of-sale applications in the retail industry. It is commonly used with Microscan readers in applications in combination with **Matchcode** when there is a need to verify that the right product is being placed in the right packaging.

Definition: **UPC** (Universal Product Code) is a fixed length, numeric, continuous symbology. UPC can have two- or five-digit supplemental bar code data following the normal code. The UPC Version A (UPC, A) symbol is used to encode a 12 digit number. The first digit is the number system character, the next five are the manufacturer number, the next five are the product number, and the last digit is the checksum character.
When enabled, the reader will read UPC Version A and UPC Version E only.

Serial Cmd: <**K473**,**UPC status**,**EAN status**,**supplementals status**,**separator status**,**separator character**,**supplemental type**,**format UPC-E as UPC-A**>

Default: **Enabled**

Options: 0 = Disabled **1 = Enabled**

EAN Status

Usage: **EAN** is the European version of the UPC symbology and is used in European market applications.

Note: **UPC** must be enabled for **EAN** to take effect.

Definition: EAN is a subset of UPC. When enabled, the reader will read UPC Version A, UPC Version E, EAN 13, and EAN 8. It also appends a leading zero to UPC Version A symbol information and transmits 13 digits. If transmitting 13 digits when reading UPC Version A symbols is not desired, disable EAN.

Note: The extra character identifies the country of origin.

Serial Cmd: <**K473**,**UPC status**,**EAN status**,**supplementals status**,**separator status**,**separator character**,**supplemental type**,**format UPC-E as UPC-A**>

Default: **Enabled**

Options: 0 = Disabled **1 = Enabled**

Supplementals Status (UPC/EAN)

Usage: Reads **Supplementals** typically used in publications and documentation.

Definition: A supplemental is a 2 to 5 digit symbol appended to the main symbol. When set to **Enabled** or **Required**, the reader reads supplemental code data that has been appended to the standard UPC or EAN codes.

Serial Cmd: <**K473**,UPC status,EAN status,**supplementals status**,separator status,separator character,supplemental type,format UPC-E as UPC-A>

Default: **Disabled**

Options: **0 = Disabled** 1 = Enabled 2 = Required

Disabled

UPC **Supplementals** will not be decoded.

Enabled

When enabled, the reader will try to decode a main and a supplemental. However, if a supplemental is not decoded, the main will be sent by itself at the end of the read cycle.

Required

When set to **Required**, both the main and the supplemental symbols must be read or a single No-Read condition results.

For example, if **Supplementals** is set to **Required**, **Separator** is enabled, and an asterisk is defined as the UPC separator character. Then the data is displayed as:

MAIN * SUPPLEMENTAL.

Note: Under no circumstances will the supplemental symbol data be sent without a main symbol.

Note: If additional symbols—other than the main or supplemental—will be read in the same read cycle, **Number of Symbols** should be set accordingly.

Separator Status (UPC/EAN)

Usage: Allows users to distinguish between the main and **Supplemental** symbols.

Definition: A character can be inserted between the standard UPC or EAN symbology and the supplemental symbology when **Supplementals** is set to **Enabled** or **Required**.

Serial Cmd: <**K473**,UPC status,EAN status,supplementals status,**separator status**,separator character,supplemental type,format UPC-E as UPC-A>

Default: **Disabled**

Options: **0 = Disabled** 1 = Enabled

Separator Character (UPC/EAN)

Note: If **Separator Character** has been changed to any other character and you wish to redefine the separator as a comma, you will need to use **ESP**.

Usage: As required by the application.

Definition: Allows the user to change the separator character from a comma to a new character.

Serial Cmd: <**K473**,UPC status,EAN status,supplementals status,separator status,
separator character,supplemental type,format UPC-E as UPC-A>

Default: , (**comma**)

Options: Any ASCII character.

Note: Whenever **Separator Character** is defined as a comma (,) sending a <**K473,s?**> command will return the current settings, including the separator character comma which appears after the separator status comma.

Supplemental Type (UPC/EAN)

Usage: As required by symbology used in application.

Definition: Allows the user to select 2 character or 5 character supplements, or both.

Serial Cmd: <**K473**,UPC status,EAN status,supplementals status,separator status,separator character,**supplemental type**,format UPC-E as UPC-A>

Default: **Both**

Options: **0 = Both** 1 = 2 characters only 2 = 5 characters only

Both

Either 2 character or 5 character supplementals will be considered valid.

2 Characters Only

Only two character supplementals will be considered valid.

5 Characters Only

Only five character supplementals will be considered valid.

Format UPC-E as UPC-A (UPC/EAN)

Definition: When disabled, the reader will output the version E symbols in their encoded 6-character format.

When enabled, the reader will format the symbol as either a 12-character UPC-A symbol or an EAN-13 symbol, depending on the state of the EAN status parameter. This formatting reverses the zero suppression that is used to generate the symbol in the UPC specification.

Serial Cmd: <**K473**,UPC status,EAN status,supplementals status,separator status,separator character,supplemental type,**format UPC-E as UPC-A**>

Default: **Disabled**

Options: **0 = Disabled** 1 = Enabled

Pharmacode

- Usage:** Used mostly with packaging for the pharmaceuticals industry.
- Definition:** Encodes up to five different numbers, each with its own color, which may be entered in decimal or “binary” format with a 1 represented by a thick bar and a 0 represented by a thin bar. Bar width is independent of height. In decimal format, each part can be up to 999,999. In binary format, each input can have up to 19 ones and zeros.
Important: When Pharmacode is enabled, other linear symbologies will not decode properly. Disable Pharmacode before reading other linear symbologies.
- Serial Cmd:** <**K477**,*status*,*fixed symbol length status*,*fixed symbol length*,*minimum number of bars*,*bar width status*,*direction*,*fixed threshold value*>
- Default:** **Disabled**
- Options:** **0 = Disabled** 1 = Enabled

Fixed Symbol Length Status (Pharmacode)

- Definition:** When enabled, the reader will check the symbol length against the symbol length field. If disabled, any length will be considered valid.
- Serial Cmd:** <**K477**,*status*,**fixed symbol length status**,*fixed symbol length*,*minimum number of bars*,*bar width status*,*direction*,*fixed threshold value*>
- Default:** **Disabled**
- Options:** **0 = Disabled** 1 = Enabled

Fixed Symbol Length (Pharmacode)

- Definition:** Specifies the exact number of bars that must be present for the reader to recognize and decode the Pharmacode symbol.
- Serial Cmd:** <**K477**,*status*,*fixed symbol length status*,**fixed symbol length**,*minimum number of bars*,*bar width status*,*direction*,*fixed threshold value*>
- Default:** **5**
- Options:** 1 to 16

Minimum Number of Bars (Pharmacode)

- Definition:** Sets the minimum number of bars that a Pharmacode symbol must have to be considered valid.
- Serial Cmd:** <**K477**,*status*,*fixed symbol length status*,*fixed symbol length*,**minimum number of bars**,*bar width status*,*direction*,*fixed threshold value*>
- Default:** **2**
- Options:** 1 to 16

Bar Width Status (Pharmacode)

Definition: If set to **Mixed**, the reader will autodiscriminate between narrow bars and wide bars. If set to **All Narrow**, all bars will be considered as narrow bars. If set to **All Wide**, all bars will be considered as wide bars. If set to **Fixed Threshold**, it will use the fixed threshold value to determine whether the bars are narrow or wide. The **Bar Width Status** setting will be ignored when the reader is able to tell the difference between the narrow and the wide bars.

Serial Cmd: <K477,status,fixed symbol length status,fixed symbol length,minimum number of bars,bar width status,direction,fixed threshold value>

Default: **Mixed**

Options: **0 = Mixed**
1 = All Narrow
2 = All Wide
3 = Fixed Threshold

Direction (Pharmacode)

Definition: Specifies the direction in which a symbol can be read.

Serial Cmd: <K477,status,fixed symbol length status,fixed symbol length,minimum number of bars,bar width status,direction,fixed threshold value>

Default: **Forward**

Options: **0 = Forward** 1 = Reverse

Fixed Threshold Value (Pharmacode)

Definition: Used when **Bar Width Status** is set to **Fixed Threshold**. Defines the minimum difference in pixels that will distinguish a narrow bar from a wide bar.

Serial Cmd: <K477,status,fixed symbol length status,fixed symbol length,minimum number of bars,bar width status,direction,fixed threshold value>

Default: **10**

Options: 1 to 65535

Postal Symbologies

Important: Postal Symbologies must have a minimum pixels-per-element value of **4** to be decoded reliably by the MicroHAWK ID.

The reader must be configured to specific read range, field of view, and camera parameters before decoding Postal Symbologies.

For optimal decode results, position the symbol as close to the center of the reader's field of view as possible.

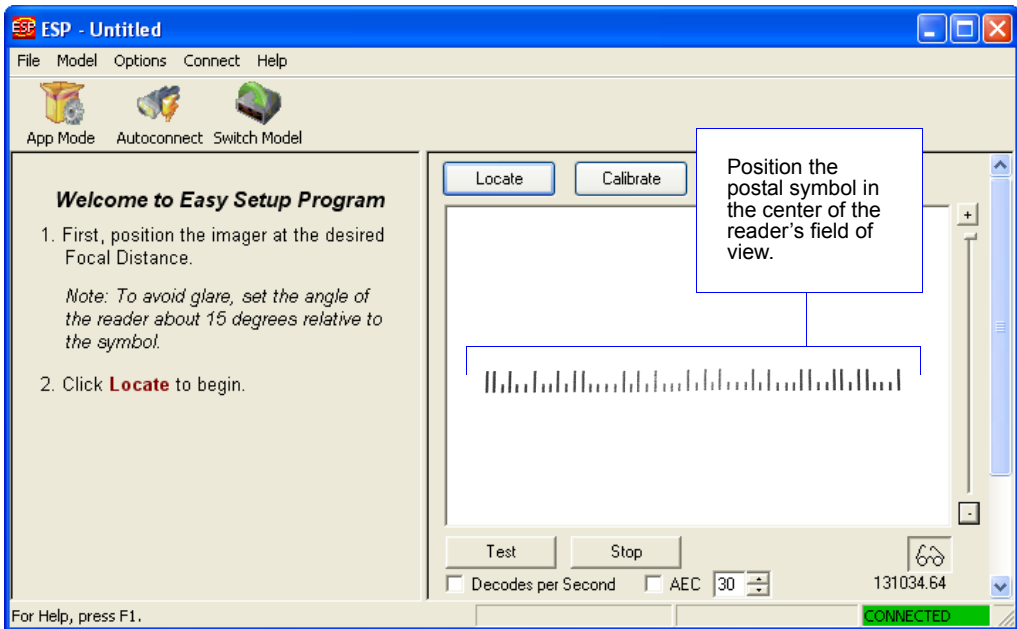

Postal Symbology Type

Usage: The following 1D **Postal Symbologies** are used in mail sortation, auditing, certified mail, registered mail, metered mail, and point-of-sale (POS) applications.

Definition: Determines the postal symbology that will be decoded by the reader.

Serial Cmd: <**K460,postal symbology type,POSTNET status,PLANET status,USPS4CB status**>

Default: **Disabled**

Options: **0 = Disabled**

1 = U.S. Post (POSTNET, PLANET, USPS4CB)

2 = Australia Post

3 = Japan Post

4 = Royal Mail

5 = KIX

6 = UPU

U.S. Post (POSTNET, PLANET, USPS4CB)

When **U.S. Post** is enabled (<**K460,1**>), the reader will only decode **POSTNET**, **PLANET**, and **USPS4CB** symbols.

Important: POSTNET Status, PLANET Status, and USPS4CB Status are enabled by default. However, if any of the three U.S. Post symbologies is set to **disabled** individually, symbols of that type will not be decoded by the reader even when U.S. Post is enabled.

For example, if **U.S. Post** is enabled but **POSTNET Status** is disabled (<**K460,1,0**>), **POSTNET** symbols will not be decoded by the reader.

See **POSTNET Status, PLANET Status, and GS1 DataBar** for more detail about U.S. Post symbologies.

Australia Post

When **Australia Post** is enabled (<**K460,2**>), the reader will only decode Australia Post symbols.

Japan Post

When **Japan Post** is enabled (<**K460,3**>), the reader will only decode Japan Post symbols.

Royal Mail

When **Royal Mail** is enabled (<**K460,4**>), the reader will only decode Royal Mail symbols.

KIX

When **KIX** is enabled (<**K460,5**>), the reader will only decode KIX symbols.

UPU

When **UPU** is enabled, the reader will decode UPU symbols.

For example, if **Postal Symbology Type** is set to **UPU** and **POSTNET Status** is enabled and (<**K460,6,1**>), the reader will attempt to decode both UPU and POSTNET symbols.

POSTNET Status

Usage: **POSTNET** is used by the United States Postal Service to direct mail. The ZIP Code or ZIP+4 Code is encoded in the symbol. Data is encoded in half-height and full-height bars, making POSTNET a “2-state” symbology. The delivery point (usually the last two digits of the address or post office box number) is also typically encoded in POSTNET symbols.

Definition: If **U.S. Post** and **POSTNET Status** are both enabled, the reader will decode POSTNET symbols.

Serial Cmd: <**K460**,postal symbology type,**POSTNET status**,**PLANET status**,**USPS4CB status**>

Default: **Enabled**

Options: 0 = Disabled

1 = Enabled

PLANET Status

Usage: **PLANET (Postal Alphanumeric Encoding Technique)** is a symbology used by the United States Postal Service to track and identify items during delivery. Each PLANET symbol is either 12 or 14 digits long, and encodes data in half-height and full-height bars, making PLANET a “2-state” symbology. The symbol always starts and ends with a full-height bar, or “guard rail”, and each individual digit is represented by a set of five bars in which two of the bars are always short.

Definition: If **U.S. Post** and **PLANET Status** are both enabled, the reader will decode PLANET symbols.

Serial Cmd: <**K460**,postal symbology type,**POSTNET status**,**PLANET status**,**USPS4CB status**>

Default: **Enabled**

Options: 0 = Disabled

1 = Enabled

USPS4CB Status

Usage: **USPS4CB**, also called **Intelligent Mail**, is used by the United States Postal Service to sort and track individual items as well as flats of mail. USPS4CB combines the capabilities of POSTNET and PLANET, and can encode 31 digits (65 bars). USPS4CB symbols are slightly longer than POSTNET symbols, and offer additional flexibility in choosing symbol height and width. Data is encoded in four types of bars ("states"), each of which is identified by a name and a value. This type of postal symbol is known as "4-state". Each bar has a "tracker", or middle section, to which an "ascender" (top section) or "descender" (bottom section) may be added. The 4-state format allows the symbol to contain more information, and makes it easier to decode. 4-state symbols can also be printed easily in a variety of media, including dot matrix, inkjet, and laser.

Definition: If **U.S. Post** and **USPS4CB Status** are both enabled, the reader will decode USPS4CB symbols.

Serial Cmd: <**K460**,postal symbology type,POSTNET status,PLANET status,**USPS4CB status**>

Default: **Enabled**

Options: 0 = Disabled

1 = **Enabled**

GS1 DataBar

DataBar Expanded

Usage: Used to encode primary and supplementary data in retail point-of-sale and other applications.

Definition: DataBar Expanded is a variable length symbology that can encode supplementary information in addition to the 14-digit EAN item identification number and is capable of encoding up to 74 numeric or 41 alphabetic characters.

Serial Cmd: <**K484,status,fixed symbol length status,fixed symbol length**>

Default: **Disabled**

Options: **0 = Disabled** 1 = Enabled

Where appropriate, use 1 (non-stacked) for better performance over 2 (stacked and non-stacked).

Fixed Symbol Length Status (DataBar Expanded)

Definition: When enabled, the reader will check the symbol length against the symbol length field, minus the embedded check character. If disabled, any length would be considered valid.

Serial Cmd: <**K484,status,fixed symbol length status,fixed symbol length**>

Default: **Disabled**

Options: **0 = Disabled** 1 = Enabled

Fixed Symbol Length (DataBar Expanded)

Usage: **Fixed Symbol Length** helps prevent truncations and increases data integrity by ensuring that only one symbol length will be accepted.

Definition: Specifies the exact number of characters that the reader will recognize (this does not include start, stop, and check character characters). The reader ignores any symbol not having the specified length.

Serial Cmd: <**K484,status,fixed symbol length status,fixed symbol length**>

Default: **14**

Options: 1 to 74

DataBar Limited

- Usage:* DataBar Limited is designed to be read by laser and CCD readers. It is not recommended for omnidirectional slot scanners.
- Definition:* Encodes a smaller 14-digit symbol (74 modules wide) that is not omnidirectional.
- Serial Cmd:* **<K483,status>**
- Default:* **Disabled**
- Options:* **0 = Disabled** 1 = Enabled

DataBar-14

- Usage:* Used in the grocery, retail, and prescription drug industries where 14-digit EAN item identification may be needed.
- Definition:* DataBar-14 is a fixed symbol length symbology that encodes 14 digits, including a 1-digit indicator. DataBar-14 is 96 modules wide. It can be stacked in two rows, it can read omnidirectionally if printed in full height, or horizontally if height-truncated for small marking.
- Serial Cmd:* **<K482,status>**
- Default:* **Disabled**
- Options:* **0 = Disabled** 1 = Enabled

PDF417

Usage: Used in applications where a large amount of information (over 32 characters) needs to be encoded within a symbol, typically where the symbol is transported from one facility to another. For example, an automobile assembly line might use a single symbol with multiple fields of information that will be read at several stations along the way, without reference to a database.

Definition: A two-dimensional, multi-row (3 to 90), continuous, variable length symbology that has high data capacity for storing up to 2,700 numeric characters, 1,800 printable ASCII characters, or 1,100 binary characters per symbol. Each symbol character consists of 4 bars and 4 spaces in a 17-module structure.

Serial Cmd: <K476,status,[unused],fixed symbol length status,fixed symbol length>

Default: **Enabled**

Options: 0 = Disabled **1 = Enabled**

Note: Sending <a1> will cause PDF417 data to be prefaced with information consisting of error correction level (ECC Level *n*), number of rows (*n* Rows), number of columns (*n* Columns), number of informative code words (*n* Info Code Words) and the number of data characters (*n* Data Characters). This feature can be disabled by re-sending <a1>.

Fixed Symbol Length Status (PDF417)

Serial Cmd: <K476,status,[unused],fixed symbol length status,fixed symbol length>

Default: **Disabled**

Options: **0 = Disabled** 1 = Enabled

Fixed Symbol Length (PDF417)

Usage: Used to increase data integrity by ensuring that only one symbol length will be accepted.

Definition: When enabled, the PDF symbol must contain the same number of characters as the symbol length setting before it can be considered a good read. The reader will ignore any symbol not having the specified length.

Serial Cmd: <K476,status,[unused],fixed symbol length status,fixed symbol length>

Default: **10**

Options: 1 to 2710

Note: **Fixed Symbol Length Status** must be enabled for **Fixed Symbol Length** to take effect.

MicroPDF417

- Usage:** Used for labelling small items that need large data capacity.
- Definition:** A variant of PDF417, a very efficient and compact stacked symbology that can encode up to 250 alphanumeric characters or 366 numeric characters per symbol.
- Serial Cmd:** <K485,status,[unused],fixed symbol length status,fixed symbol length>
- Default:** Disabled
- Options:** 0 = Disabled 1 = Enabled

Fixed Symbol Length Status (MicroPDF417)

- Serial Cmd:** <K485,status,[unused],fixed symbol length status,fixed symbol length>
- Default:** Disabled
- Options:** 0 = Disabled 1 = Enabled

Fixed Symbol Length (MicroPDF417)

- Usage:** Used to increase data integrity by ensuring that only one symbol length will be accepted.
- Definition:** When enabled, the MicroPDF417 symbol must contain the same number of characters as the symbol length setting before it can be considered a good read. The reader will ignore any symbol not having the specified length.
- Serial Cmd:** <K485,status,[unused],fixed symbol length status,fixed symbol length>
- Default:** 10
- Options:** 1 to 366

Note: Fixed Symbol Length Status must be enabled for Fixed Symbol Length to take effect.

Composite

When set to **Enabled** or **Required**, will decode the 2D composite component of a linear symbol. The linear symbol can be DataBar-14, DataBar Expanded, DataBar Limited, EAN-128, UPC-A, EAN-13, EAN-8, and UPC-E.

Usage: Allows reading by both linear and 2D readers.

Definition: Combines 2D and linear width-modulated symbology on the same symbol where different messages can be read by each reader type.

Serial Cmd: <**K453,mode,separator status,separator**>

Default: **Disabled**

Options: **0 = Disabled** 1 = Enabled 2 = Required

Enabled

If **Composite** is set to **Enabled**, the reader will decode both the 2D composite and linear components. However, if the 2D composite component is not decoded, the linear data will be sent by itself at the end of the read cycle.

Required

If set to **Required**, the reader must decode both components, or a No-Read will occur.

Separator Status (Composite)

Usage: Allows the user to distinguish between the main and **Supplemental** symbols.

Definition: Separates the linear and the composite component.

Serial Cmd: <**K453,mode,separator status,separator**>

Default: **Disabled**

Options: **0 = Disabled** 1 = Enabled

Separator Character (Composite)

Note: The Separator Character will be the same as the character defined in the **Multisymbol Separator** field of the <**K222**> command.

Usage: As required by the application.

Definition: Allows the user to change the separator character from a comma to a new character.

Serial Cmd: <**K453,mode,separator status,separator**>

Default: , (comma)

Options: Any ASCII character.

DotCode

Important: When **DotCode** is enabled, no other symbologies will be decodable. You must disable DotCode to decode symbols of any other type.

DotCode Status

Serial Cmd: <**K497,status,rotation mode**>

Default: **0 = Disabled**

Options: **0 = Disabled**

1 = Enabled

Disabled

The reader will not attempt to decode DotCode symbols.

Enabled

The reader will attempt to decode DotCode symbols.

Rotation Mode

Serial Cmd: <**K497,status,rotation mode**>

Default: **0 = No Rotation**

Options: **0 = No Rotation**

1 = Enabled

2 = Omnidirectional

No Rotation

The reader will decode horizontal and vertical symbols (**+/- approximately 3 degrees**).

Low Rotation

The reader will decode **+/- approximately 10 degrees** from the horizontal or vertical symbols. It is slightly slower than the No Rotation option.

Omnidirectional

The reader will support **360 degree** reading. Omnidirectional is significantly slower than the other two options.

DotCode

7 I/O Parameters

Contents

I/O Parameters by ESP	7-2
I/O Parameters Serial Commands	7-3
Symbol Data Output	7-4
No-Read Message	7-8
Read Duration Output	7-9
Output Indicators	7-10
LED Configuration	7-14
Serial Verification	7-15
Setup Button	7-16
Setup Button Modes	7-18
Configurable Output 1	7-20
Trend Analysis Output 1	7-23
ISO/IEC 16022 Symbol Quality Output 1	7-26
Diagnostic Output 1	7-29
Configurable Output 2	7-30
Trend Analysis Output 2	7-30
ISO/IEC 16022 Symbol Quality Output 2	7-30
Diagnostic Output 2	7-30
Configurable Output 3	7-31
Trend Analysis Output 3	7-31
ISO/IEC 16022 Symbol Quality Output 3	7-31
Diagnostic Output 3	7-31
Power-On/Reset Counts	7-32
Time Since Reset	7-33
Service Message	7-34
User-Assigned Name	7-35
Frame Information	7-36
Image Output	7-37
Database Identifier Output	7-40
Quality Output	7-41
EZ Trax Output	7-42
Image Push to Host	7-45
Image Push to Host Detailed Setup	7-47

This section includes instructions on setting up conditions for changing input/output electrical transitions for control of the reader's internal and external devices. A discrete I/O (in/out) signal is an electrical transition from one voltage level to another so that digital switching can occur.

I/O Parameters by ESP

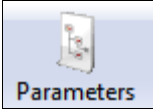

Click the **Parameters** button and then the **I/O** tab.

Parameters	ESP Values
<input checked="" type="checkbox"/> I/O Parameters	
<input checked="" type="checkbox"/> Symbol Data Output	Good Read
<input checked="" type="checkbox"/> No Read Message	Enabled
<input checked="" type="checkbox"/> Read Duration Output	Disabled
<input checked="" type="checkbox"/> Output Object Info	Disabled
<input checked="" type="checkbox"/> Output Indicators	
<input checked="" type="checkbox"/> Serial Verification	
<input checked="" type="checkbox"/> Image Storage	Disabled
<input checked="" type="checkbox"/> Image Storage Location	RAM
<input checked="" type="checkbox"/> EZ Trax Output	Disabled
<input checked="" type="checkbox"/> Setup Button	Enabled
<input checked="" type="checkbox"/> Calibration Options	
<input checked="" type="checkbox"/> Database Identifier Output	Disabled*
<input checked="" type="checkbox"/> Output 1 Parameters	Disabled*
<input checked="" type="checkbox"/> Output 2 Parameters	Enabled
<input checked="" type="checkbox"/> Output 3 Parameters	
<input checked="" type="checkbox"/> Quality Output	
Quality Output Separator	,
Decodes/Trigger Status	Disabled

To change a setting, **double-click** the setting and use your cursor to scroll through the options.

To open nested options, **single-click** the + and it will become a - as shown above.

I/O Parameters Serial Commands

Power On/Reset Counts	<K406,power-on,resets,power-on saves,customer default saves>
Time Since Reset (Read-Only)	<K407,hours,minutes>
Service Message	<K409,status,service message,threshold,resolution>
User-Defined Name	<K412,user-defined name>
Serial Verification	<K701,serial command echo status,control/hex output>
Quality Output Separator	<K704,quality output separator,decodes per trigger status>
Symbol Data Output	<K705,status,when to output,symbology identifier status>
Read Duration Output	<K706,status,separator>
No-Read Message	<K714,status,message>
Object Output Information	<K734,output frame number status,output coordinates status>
LED Configuration	<K737,ISO/IEC 16022 grade>
Green Flash and Target LEDs	<K750,green flash LED status,target pattern LED status,green flash duration>
EZ Trax Output	<K757,EZ Trax Enable,Transfer Port,EZ Trax Image Mode,Image Format,Image Quality,Object Info Enable,Grade Enable>
Database Identifier Output	<K759,status,separator character>
Image Push to Host	<K763,Image Storage Status,Stored Image Type,Image Storage,Image File Format,Image Quality,Image Scale,File Save Options>
Image Push to Host Detail Setup	<K763,Image Storage Location,FTP Host Info,Transfer Optimization, RAM Drive Size in MB,Save Image Until,Action at Image Storage Limit>
Setup Button	<K770,global status,default on power-on,load configuration database,save for power-on>
Setup Button Modes	<K771,button option 1,button option 2,button option 3,button option 4>
Trend Analysis Output 1	<K780,trend analysis mode,number of triggers,number to output on,decodes per trigger>
Trend Analysis Output 2	<K781,trend analysis mode,number of triggers,number to output on,decodes per trigger>
Trend Analysis Output 3	<K782,trend analysis mode,number of triggers,number to output on,decodes per trigger>
Diagnostic Output 1	<K790,service unit message status>
Diagnostic Output 2	<K791,service unit message status>
Diagnostic Output 3	<K792,service unit message status>
ISO/IEC 16022 Symbol Quality Output 1	<K800,output on symbol contrast,symbol contrast threshold,output on print growth,print growth threshold,output on axial non-uniformity,axial non-uniformity threshold,output on Unused ECC,Unused ECC threshold>
ISO/IEC 16022 Symbol Quality Output 2	<K801,output on symbol contrast,symbol contrast threshold,output on print growth,print growth threshold,output on axial non-uniformity,axial non-uniformity threshold,output on Unused ECC,Unused ECC threshold>
ISO/IEC 16022 Symbol Quality Output 3	<K802,output on symbol contrast,symbol contrast threshold,output on print growth,print growth threshold,output on axial non-uniformity,axial non-uniformity threshold,output on Unused ECC,Unused ECC threshold>
Output 1 Parameters	<K810,output on,output state,pulse width,output mode>
Output 2 Parameters	<K811,output on,output state,pulse width,output mode>
Output 3 Parameters	<K812,output on,output state,pulse width,output mode>

Symbol Data Output

Symbol Data Output Status

Note: **Symbol Data Output** relates to data and should not be confused with **Outputs 1, 2, and 3** listed in the **Output Parameters** which describe output states and functions.

Usage: Useful when the host needs symbol data only under certain conditions.

Definition: Defines the conditions under which decoded symbol data is transmitted to the host.

Serial Cmd: <**K705,symbol data output status,when to output,symbology identifier status**>

Default: **Good Read**

Options: 0 = Disabled

1 = Match

2 = Mismatch

3 = Any Good Read

4 = Only If All Good Reads

Note: **Symbol Data Output Status**, if set to **Match** or **Mismatch**, will not take effect unless **Matchcode Type** is enabled and a master symbol is loaded into memory.

Disabled

Usage: It is useful when an application only needs to use the discrete outputs and can allow the reader to do the decision-making. When **Disabled**, the host does not need the symbol data and the communication lines are used only for setup and status checks.

Definition: When set to **Disabled**, the reader will not transmit any data that is generated during a read cycle (symbols, No-Reads, etc.)

Match

Usage: **Match** is used in an application that requires specific symbol information and needs to sort, route, or verify based on matching the specific symbol data.

Definition: When set to **Match**, the reader transmits symbol data whenever a symbol matches a master symbol. However, if **Matchcode Type** is **Disabled**, it transmits on any good read.

Note: A No-Read can still be transmitted if **Enabled**.

Mismatch

Usage: Mismatch is typically used as a flag within the host system to prevent an item from being routed in the wrong container.

Definition: With Mismatch enabled, the reader transmits symbol data whenever the symbol data information does NOT match the master symbol.

Note: A No-Read can still be transmitted if **Enabled**.

Any Good Read

Usage: **Any Good Read** is used when an application requires all symbol data to be transmitted. It's typically used in tracking applications in which each object is uniquely identified.

Definition: With **Any Good Read** enabled, the reader outputs symbol data for any qualified symbol in the read cycle regardless of **Matchcode Type** setting. **No Read** is output if no symbols are qualified.

Only If All Good Reads

Definition: With **Only If All Good Reads** enabled, the reader outputs symbol data only when all symbols in the read cycle are qualified. **No Read** is output if no symbols are qualified.

When to Output Symbol Data

Definition: This command allows the user to choose when symbol data can be sent to the host.

Serial Cmd: <K705,symbol data output status,**when to output**,symbology identifier status>

Default: **As Soon As Possible**

Options: **0 = ASAP** 1 = End of Read Cycle

As Soon As Possible

Usage: **As Soon As Possible** is useful in applications in which symbol data needs to be moved quickly to the host, typically when the host is making decisions based on symbol data.

Definition: Enabling **As Soon As Possible** causes symbol data to be sent to the host immediately after a symbol has been successfully decoded.

Note: More than one decode might in fact be required to qualify as a good read, depending on how **Decodes Before Output** is set.

End of Read Cycle

Usage: **End of Read Cycle** is useful in timing-based systems in which the host is not ready to accept data at the time that it is decoded.

Definition: Enabling **End of Read Cycle** means that symbol data does not get sent to the host until the read cycle ends with a timeout or new trigger.

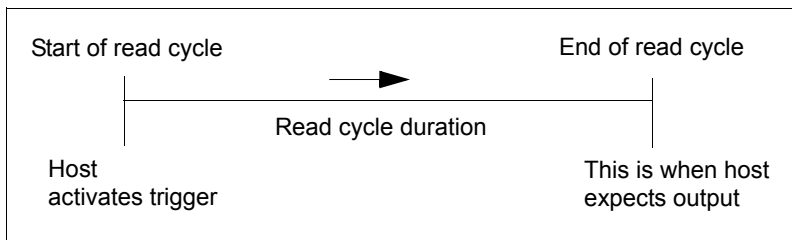

Symbology Identifier Status

Definition: This command allows the user to choose when symbol data can be sent to the host.

Serial Cmd: <**K705**,symbol data output status,when to output,**symbology identifier status**>

Default: **Disabled**

Options: **0 = Disabled** 1 = Enabled

Disabled

When set to **Disabled**, the symbol data output does not contain symbology information.

Enabled

When set to **Enabled**, the symbol data output contains a three-character symbology identifier sequence.

No-Read Message

Usage: Used in applications where the host needs serial verification that a symbol has not been read and especially useful in new print verification.

Definition: When enabled, and if no symbol has been decoded before timeout or the end of the read cycle, the No-Read message will be transmitted to the host.

No-Read Message Mode

Serial Cmd: <K714,**No-Read message status**,No-Read message>

Default: **Enabled**

Options: 0 = Disabled **1 = Enabled**

Disabled

Only symbol data is output after a read cycle.

Enabled

When the reader is in a triggered mode, a No-Read message will be appended for each failed read attempt.

No-Read Message

Definition: Any combination of ASCII characters can be defined as the No-Read message.

Serial Cmd: <K714,**No-Read message status**,**No-Read message**>

Default: **NOREAD**

Options: A string of up to 64 characters.

Note: No-Read Message will only be transmitted if **Symbol Data Output** is set to **Match**, **Mismatch**, or **Good Read**.

No-Read Message can be set to any ASCII character.

Read Duration Output

Usage: Useful in evaluating actual read cycle timing results, especially when initially setting up an application to determine maximum line speed (obtainable based on spacing between symbols.)

Definition: When enabled the duration of the read cycle (in milliseconds) is appended to the symbol data.

The read duration is the time from the beginning of the read cycle until data is output.

Read Duration Output Mode

Serial Cmd: <K706,status,separator>

Default: Disabled

Options: 0 = Disabled 1 = Enabled

Important: To measure the entire read cycle when in **External Level** trigger mode, set **When to Output Symbol Data** to **End of Read Cycle**.

This output can measure over 49 days' worth of duration; if exceeded, the "OVERFLOW" message will be output in place of the duration.

Read Duration Output Separator

Definition: User defined character that separates the symbol information from the **Read Duration Output**.

Serial Cmd: <K706,status,separator>

Default: [space character]

Options: Any ASCII character.

Output Indicators

The MicroHAWK ID has three LED arrays, as follows:

1. A target pattern of blue LEDs for centering the field of view, which is projected from the front of the reader.
2. An array of green LEDs projected from the front of the reader that can be programmed to flash in response to user-defined conditions.
3. A row of five status LEDs on the side of the reader.

Green Flash Mode

Usage: Used as a visual verification that a good read has occurred.

Definition: An array of green LEDs in the front of the reader can be programmed to flash in response to user-defined conditions.

Serial Cmd: <K750,green flash mode,target pattern status,green flash duration>

Default: **Good Read**

Options: 0 = Disabled

1 = Good Read

2 = Static Presentation

3 = Match

4 = Mismatch

5 = Strobe

Disabled

Green flash LEDs are disabled.

Good Read

Green flash LEDs will flash when a good read condition is met or when **Matchcode** is enabled and a match occurs.

Static Presentation Mode

Static Presentation Mode is used in conjunction with **Continuous Read Mode**: <K200,0>.

When operating in **Static Presentation Mode**, the red LEDs will illuminate while the reader is searching for a symbol in **Continuous Read Mode**. When a symbol is placed in the field of view and a good read occurs, the green LEDs will illuminate and stay on for the duration of time set in **Green Flash Duration**. Only one read will occur during that time unless more than one symbol is enabled in **Number of Symbols**.

Note: If **Static Presentation Mode** is selected but the reader is not in **Continuous Read**, the **Green Flash** will not occur.

To use Static Presentation:

1. Enable **Continuous Read**.
2. Select the number of symbols.
3. Enable **Static Presentation** in **Green Flash Mode**.
4. Select the read time in **Green Flash Duration**.

Match

The green LEDs will flash when a match condition is met. If multisymbol is enabled, then green flash LEDs will illuminate only if all symbols qualify as a match. If matchcode is disabled, then this mode will activate the LEDs on a good read.

Mismatch

Same as **Match**, except that LEDs will illuminate on a mismatch.

Strobe

Green flash LEDs will act as an illumination strobe for image capture. If it is required that the green flash LEDs be the *only* illumination for image capture, then the internal illumination LEDs can be disabled.

Target Pattern

Usage: Assists users in positioning and locating symbols in the center of the reader's field of view.

Definition: The user can control when the targeting system is ON or OFF, and can save this condition for power-on.

Serial Cmd: <K750,green flash mode,**target pattern status**,green flash duration>

Default: **Always ON**

Options:

- 0 = Always OFF
- 1 = ON only when not in the read cycle
- 2 = ON only when in the read cycle
- 3 = Always ON**

Always OFF

The target pattern will remain OFF at all times unless overridden by an operational command.

ON Only When Not in the Read Cycle

The target pattern is always ON except during the read cycle. If the operational command overrides this setting, the target pattern will remain on at all times.

ON Only When in the Read Cycle

The target pattern will remain OFF except during the read cycle. If the operational command overrides this setting, the target pattern will remain on at all times.

Always ON

The target pattern is always ON.

Green Flash Duration

Usage: Provides visual verification that a good read has occurred.

Definition: When a good read occurs, the green LEDs will illuminate and stay on for the time set in the **Green Flash Duration** value.

Serial Cmd: **<K750,green flash mode,target pattern status,green flash duration>**

Default: **100** (1 second)

Options: 0 to 65535 (in 10 ms increments)

LED Configuration

Usage: Useful as a visible indicator of read rates and symbol quality.

Definition: Determines the mode in which the status LEDs operate.

Serial Cmd: <K737,LED mode,ISO/IEC 16022 grade>

Default: **Standard**

Options: **0 = Standard** 1 = ISO/IEC 16022 grade

In ISO/IEC 16022 grade mode the LEDs represent the grade of the first Data Matrix symbol decoded in the read cycle.

The parameter to be graded is set in the **ISO/IEC 16022 Grade** options.

For example, to program the LEDs to indicate the ISO/IEC 16022 print growth grade, set **LED Mode** to **ISO/IEC 16022 Grade** and set **ISO/IEC 16022 Grade** to **Print Growth**. If all the LEDs from 20% to 100% are illuminated, the read result is a grade A; if only the 20% LED is illuminated, the result is a grade F.

Standard

In **Standard Mode**, the STATUS LED indicates read cycle status and the GOOD READ LED illuminates upon a good read at the end of a read cycle. In a read rate test, these LEDs represent the percentage of good reads per images captured.

ISO/IEC 16022 Grade

Usage: Provides visual grading of specific ISO/IEC 16022 parameters.

Definition: Determines which ISO/IEC 16022 parameter the reader will grade via the LEDs.

Serial Cmd: <K737,LED mode,ISO/IEC 16022 grade>

Default: **Final Grade**

Options: **0 = Final Grade**
1 = Symbol Contrast
2 = Print Growth
3 = Axial Non-Uniformity
4 = Unused ECC

Serial Verification

Allows the user to verify configuration command status.

Serial Command Echo Status

Usage: This command is useful in removing any doubt about the reader's interpretation of any configuration command.

For example, if the current preamble is "SOM" and **<K701,1,START>** is entered, the reader will echo back **<K701,SOM>** since the attempted entry "START" exceeds the four character limit for that command. Therefore, it is rejected and the existing "SOM" message is echoed back and remains the preamble message.

Definition: When enabled, a configuration command received from the host is echoed back to the host with the resultant settings.

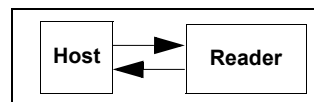

Function: If a command with multiple fields is processed, some of the fields may have been processed properly while others were not. The changes will appear in the string echoed back so that the user will know which fields did or did not change.

Serial Cmd: **<K701,serial command echo status,control/hex output>**

Default: **Disabled**

Options: **0 = Disabled** 1 = Enabled

Control/Hex Output

Usage: Useful for viewing settings with binary characters when using serial commands on a terminal.

Definition: Determines the response to a **Serial Command Echo** or status request command.

When set to **Control**, two characters are transmitted to represent a non-displayable character. For example, a carriage return will be shown as: **^M**.

Serial Cmd: **<K701,serial command echo status,control/hex output>**

Default: **Control**

Options: **0 = Control** 1 = Hex

Setup Button

The Setup button has four positions, selectable by the length of time the button is held down. Each position can be programmed for any of eight options.

Definition: Serves as a master switch to enable/disable the Setup button status.

Serial Cmd: <**K770,global status,default on power-on,load Configuration Database,save for power-on**>

Default: **Enabled**

Options:

- 0 = Disabled
- 1 = Enabled**
- 2 = Trigger
- 3 = Unlatch Outputs
- 4 = Parameter Switch

Global Status

Disabled

When set to **Disabled**, the Setup button does not function.

Enabled

When selected, the Setup button is enabled and the function of each button position is selected by the **Setup Button Mode** command.

Trigger

When selected, the Setup button acts as a trigger for the imager to start and end read cycles. All other button operations are inactive.

In External Level: The read cycle endures for as long as the Setup button is pressed, unless a timeout occurs and **Timeout** is enabled for **End of Read Cycle**.

In External Edge: As with **Level**, **Edge** allows a read cycle to be initiated by pressing the Setup button, but unlike **Level**, the read cycle ends with a good read output, a timeout, or a new trigger.

Unlatch Outputs

In this configuration, the Setup button will unlatch any logic outputs that have been latched.

Parameter Switch

The parameter switch toggles between custom defaults and power-on settings. The condition is the same as that achieved by sending the <**Arc**> and <**Arp**> commands consecutively.

Default on Power-On

Definition: When enabled, if the Setup button is held down on power-on the imager will default to customer defaults and save for power-on. This is the same as sending a **<Zrc>** command.

Serial Cmd: **<K770,global status,default on power-on,load Configuration Database,save for power-on>**

Default: **Enabled**

Options: 0 = Disabled **1 = Enabled**

Load Configuration Database

Definition: Allows the user to load the Configuration Database with calibration results. When the user performs a calibration using the Setup button, all the database entries are moved down one index and the results of the calibration are saved to index 1. The results will be saved as current settings as well.

Serial Cmd: **<K770,global status,default on power-on,load Configuration Database,save for power-on>**

Default: **Enabled**

Options: 0 = Disabled **1 = Enabled**

Save for Power-On

Definition: If enabled, after calibration is complete, all parameters will be saved for power-on.

Serial Cmd: **<K770,global status,default on power-on,load Configuration Database,save for power-on>**

Default: **Disabled**

Options: **0 = Disabled** 1 = Enabled

Setup Button Modes

Usage: Useful for performing multiple, repetitive tasks at the work site.

Definition: The global status field for the Setup button must be enabled for button processing to start. Once you press the button the reader will sequence through each button position. If you release the button after the button position but before the next button option starts, the reader will execute the action programmed for that button position. The status LEDs and the green flash will also illuminate to signal the current position. All button positions have the same configurable options. Also note that a quick press and release of the button before any button position is the same as if a position selected was configured as disabled.

Serial Cmd: <K771,button option 1,button option 2,button option 3,button option 4>

Options:

Button Option 1	Button Option 2	Button Option 3	Button Option 4
0 = Disabled	0 = Disabled	0 = Disabled	0 = Disabled
1 = Read Rate	1 = Read Rate	1 = Read Rate	1 = Read Rate
2 = Calibrate	2 = Calibrate	2 = Calibrate	2 = Calibrate
3 = Save for Power-On	3 = Save for Power-On	3 = Save for Power-On	3 = Save for Power-On
4 = Unused	4 = Unused	4 = Unused	4 = Unused
5 = Load New Master	5 = Load New Master	5 = Load New Master	5 = Load New Master
6 = Unused	6 = Unused	6 = Unused	6 = Unused
7 = Target System	7 = Target System	7 = Target System	7 = Target System
8 = Unused	8 = Unused	8 = Unused	8 = Unused
9 = Bar Code Config.	9 = Bar Code Config.	9 = Bar Code Config.	9 = Bar Code Config.

Disabled

When set to disabled, the associated button position will have no function associated with it, and the position will be skipped over.

Read Rate

Read Rate will be initiated when the associated button position is selected. Read Rate will perform decodes/second and is the same as sending a <C> from the terminal. To exit Read Rate Mode quickly press and release the Setup button.

Calibrate

Calibration will be initiated when the associated button position is selected. To abort calibration, quickly press and release the Setup button.

Save for Power-On

All imager settings will be saved to non-volatile memory to be recalled on power-on whenever the associated button position is selected. This is the same as sending a <Z> from the terminal.

Load New Master

Functions in the same way as new master pin input whenever the associated button position is selected. The new master pin's **Consecutive Decode** requirement holds true for this function.

Target System

Turns on the target pattern whenever the associated button position is selected. To disable, quickly press and release the Setup button.

Note: This mode is the only one that does not require that the button be released before taking effect. If it is necessary to have the target system on before another operation such as calibration or read rate is performed, ensure that the target system mode is assigned a lower position so that it will be activated first.

Bar Code Configuration

Enables bar code configuration mode whenever the associated button position is selected. When enabled, the imager can accept configuration commands from symbols. To disable, quickly press and release the Setup button.

Setup Button Operation

To execute Setup button commands:

Position 1

Hold down button until the 20% LED illuminates.

Position 2

Hold down button until the 20% and 40% LEDs illuminate.

Position 3

Hold down button until the 20%, 40%, and 60% LEDs illuminate.

Position 4

Hold down button until the 20%, 40%, 60%, and 80% LEDs illuminate.

Configurable Output 1

<input type="checkbox"/> Output 1 Parameters	
Output On	Trend Analysis
Output State	Normally Closed
Pulse Width	5
Output Mode	Pulse
<input checked="" type="checkbox"/> Trend Analysis	
<input checked="" type="checkbox"/> Symbol Quality (ISO/IEC 16022)	
<input type="checkbox"/> Diagnostics	

Usage: This option provides discrete signalling to host software to control external devices such as PLCs and relays. It is useful for routing, sorting, and preventing mis-packaging and mis-routing.

Definition: Sets the discrete output functions for specific user-selected conditions. Allows the user to determine when an output (or outputs) will be activated.

Serial Cmd: <K810,output on,output state,pulse width,output mode>

Default: Mismatch or No-Read

Options:

- 0 = Mismatch or No-Read
- 1 = Match (or Good Read)
- 2 = Mismatch
- 3 = No-Read
- 4 = Trend Analysis
- 5 = Symbol Quality
- 6 = Diagnostic Warning
- 7 = In Read Cycle

Note: If **Output On** is set to any mode containing **Match** or **Mismatch**, the transition (switching) will only occur if **Matchcode Type** is enabled and **Master Symbol(s)** are loaded into memory.

Mismatch or No-Read

Activates discrete output when the data does not match that of the master symbol or the symbol has not been decoded before the end of the read cycle.

Match (or Good Read)

Activates a discrete output when the symbol data matches the master symbol.

Mismatch

Activates a discrete output when symbol data does not match that of the master symbol.

No-Read

Activates a discrete output when symbol data is not decoded before the end of the read cycle.

Trend Analysis

Usage: Typically used when successful decodes are occurring but a discrete output is needed to flag a trend in quality issues.

Definition: Activates discrete output when a trend analysis condition is met, depending on the trend analysis option enabled.

Symbol Quality

Usage: Typically used when a discrete indication is needed to flag a symbol quality condition.

Definition: Activates discrete output when a symbol quality condition is met, depending on the symbol quality option enabled.

Diagnostic Warning

Usage: Typically used when a discrete indication of a diagnostic condition is needed.

Definition: Activates discrete output when a diagnostic warning condition is met, depending on the diagnostic option enabled.

In Read Cycle

Definition: Activates a discrete output when the reader is in a read cycle.

Output State

Definition: Sets the active electrical state of the discrete output.

Serial Cmd: <**K810,output on,output state,pulse width,output mode**>

Default: **Negative**

Options: **0 = Normally Open** 1 = Normally Closed

Pulse Width

Definition: Sets the time in 10 ms increments that the discrete output remains active.

Serial Cmd: <**K810,output on,output state,pulse width,output mode**>

Default: **5** (Corresponds to 50 ms)

Options: 0 to 255 (0 to 2.55 seconds). Divide the number entered on the command line by 100 for time in seconds.

Output Mode

Definition: Sets the condition in which the discrete output is de-activated.

Serial Cmd: <**K810,output on,output state,pulse width,output mode**>

Default: **Pulse**

Options: **0 = Pulse**
2 = Latch Mode 2
3 = Latch Mode 3

Pulse

This is the default mode of operation in which the programmable output is activated when the **Output On** condition has been met and held active for the duration of the selected pulse width.

Latch Mode 2 (*Unlatch Opposite Condition*)

The programmable output is activated when the **Output On** condition has been met and held active until the opposite condition selected under **Output On** has been met.

For example, if **No-Read** is enabled under **Output On**, the programmable output will go active on a No-Read and remain active until the opposite condition, a good read, occurs.

Latch Mode 3 (*Unlatch Re-enter Read Cycle*)

The programmable output is active when the Output On condition has been met and is held active until a new read cycle begins.

Note: All of the **Output On** modes are inhibited when any **Output on Warning** is active for **Output 1**.

Trend Analysis Output 1

Note: **Output On** under **Output 1 Parameters** must be set to **Trend Analysis** for this output to function.



Under **Output 1 Parameters**, expand the **Trend Analysis** tree:

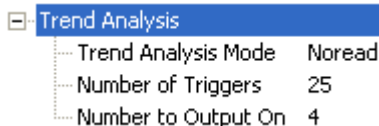

Usage: Useful in cases where the user doesn't want to shut down for one condition but wants to monitor quality and read conditions.

Definition: Applies **Trend Analysis** settings to **Output 1**.
With **Trend Analysis**, the user can track the occurrences and frequency of mismatches, No-Reads, and the number of reads per trigger, and output the results to any of three outputs.

Example: *Trend Analysis Mode = No-Read*
Trigger Evaluation Period= 25 triggers (read cycles)
Number to Output On = 4

In this example, the reader will activate an output when 4 No-Reads occur within a period of 25 triggers (read cycles).

Trend Analysis Mode

Definition: Sets the trend condition (**Mismatch**, **No-Read**, or **Decodes per Trigger**) that will activate the output.

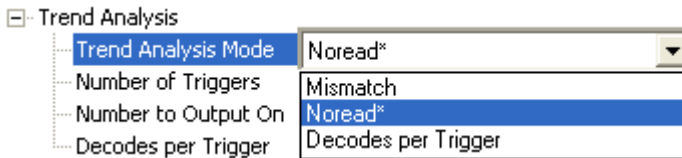

Serial Cmd: <K780,**trend analysis mode**,trigger evaluation period,number to output on,decodes per trigger threshold>

Default: **No-Read**

Options:
0 = Mismatch
1 = No-Read
2 = Decodes per Trigger

Mismatch

Output will be activated when the number of mismatches equals the value entered for **Number to Output On** within the trigger window selected in **Number of Triggers**.

No-Read

Output will be activated when the number of No-Reads equals the value entered for **Number to Output On** within the trigger window selected in **Number of Triggers**.

Decodes per Trigger

Output will be activated when the number of decodes equals the value entered for **Number to Output On** within the trigger window selected in **Number of Triggers**.

Trigger Evaluation Period

Definition: The number of triggers to examine for the trend analysis condition.

Serial Cmd: <**K780**,trend analysis mode,**trigger evaluation period**,number to output on,decodes per trigger threshold>

Default: 0

Options: 0 to 255

Number to Output On

Usage: *Example:* If **Number to Output On** is set to 3 and **Trend Analysis Mode** is set to **No-Read**, then the output will not be activated until 3 No-Reads have occurred.

Definition: Sets the number of **Trend Analysis Mode** events (mismatches, No-Reads, or reads/trigger as configured by Trend Analysis Mode) to occur within the trigger evaluation period before activating the associated output.

Serial Cmd: <**K780**,trend analysis mode,**trigger evaluation period**,**number to output on**,decodes per trigger threshold>

Default: 0

Options: 0 to 255

Decodes per Trigger Threshold

Definition: The appropriate output will be activated if, at the end of the read cycle, the symbol decode count is below this setting.

Note: To activate this feature the reader must be in Decodes per Trigger mode. To put the reader in this mode during the read cycle and the Trend Analysis operation, the Decodes per Trigger status in the quality settings must be enabled. Enabling this setting will also append the decode count to the symbol data.

Serial Cmd: <**K780**,trend analysis mode,**trigger evaluation period**,number to output on,**decodes per trigger threshold**>

Default: 0

Options: 0 to 65535

ISO/IEC 16022 Symbol Quality Output 1

Note: Output On under **Output 1 Parameters** must be set to **Symbol Quality** for this output to function.



Under **Output 1 Parameters**, expand the **Symbol Quality (ISO/IEC 16022)** tree.

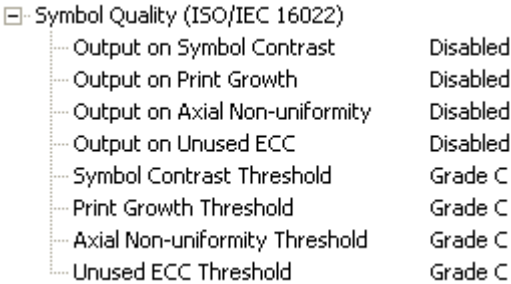

Output on Symbol Contrast

- Usage:** Lets the user know if symbol quality is less than acceptable.
- Definition:** If enabled, toggles Output 1 to an active state when **Symbol Contrast Threshold** is met.
- Serial Cmd:** <K800,output on symbol contrast,symbol contrast threshold,output on print growth,print growth threshold,output on axial non-uniformity,axial non-uniformity threshold,output on UEC,UEC threshold>
- Default:** **Disabled**
- Options:** **0 = Disabled** 1 = Enabled

Output on Print Growth

- Usage:** Lets the user know if symbol quality is less than acceptable.
- Definition:** If enabled, toggles **Output 1** to an active state when **Print Growth Threshold** is met.
- Serial Cmd:** <K800,output on symbol contrast,symbol contrast threshold,**output on print growth**,print growth threshold,output on axial non-uniformity,axial non-uniformity threshold,output on UEC,UEC threshold>
- Default:** **Disabled**
- Options:** **0 = Disabled** 1 = Enabled

Output on Axial Non-Uniformity

- Usage:** Lets the user know if symbol quality is less than acceptable.
- Definition:** If enabled, toggles **Output 1** to an active state when **Axial Non-Uniformity Threshold** is met.
- Serial Cmd:** <**K800**,output on symbol contrast,symbol contrast threshold,output on print growth,print growth threshold,**output on axial non-uniformity**,axial non-uniformity threshold,output on UEC,UEC threshold>
- Default:** **Disabled**
- Options:** **0 = Disabled** 1 = Enabled

Output on Unused Error Correction

- Usage:** Lets the user know if symbol quality is less than acceptable.
- Definition:** If enabled, toggles **Output 1** to an active state when **UEC Threshold** is met.
- Serial Cmd:** <**K800**,output on symbol contrast,symbol contrast threshold,output on print growth,print growth threshold,output on axial non-uniformity,axial non-uniformity threshold,**output on UEC**,UEC threshold>
- Default:** **Disabled**
- Options:** **0 = Disabled** 1 = Enabled

Symbol Contrast Threshold

- Usage:** Lets the user set the acceptable level of symbol quality.
- Definition:** Conforms to ISO/IEC 16022 symbol quality grading (A,B,C,D).
- Serial Cmd:** <**K800**,output on symbol contrast,**symbol contrast threshold**,output on print growth,print growth threshold,output on axial non-uniformity,axial non-uniformity threshold,output on UEC,UEC threshold>
- Default:** **Grade C**
- Options:** 0 = Grade A
1 = Grade B
2 = Grade C
3 = Grade D

Print Growth Threshold

- Usage:* Lets the user set the acceptable level of symbol quality.
- Definition:* Conforms to ISO/IEC 16022 symbol quality grading (A,B,C,D).
- Serial Cmd:* <**K800**,output on symbol contrast,symbol contrast threshold,output on print growth,**print growth threshold**,output on axial non-uniformity,axial non-uniformity threshold,output on UEC,UEC threshold>
- Default:* **Grade C**
- Options:* 0 = Grade A
1 = Grade B
2 = Grade C
3 = Grade D

Axial Non-Uniformity Threshold

- Usage:* Lets the user set the acceptable level of symbol quality.
- Definition:* Conforms to ISO/IEC 16022 symbol quality grading (A,B,C,D).
- Serial Cmd:* <**K800**,output on symbol contrast,symbol contrast threshold,output on print growth,print growth threshold,output on axial non-uniformity,**axial non-uniformity threshold**,output on UEC,UEC threshold>
- Default:* **Grade C**
- Options:* 0 = Grade A
1 = Grade B
2 = Grade C
3 = Grade D

Unused Error Correction Threshold

- Usage:* Lets the user set the acceptable level of symbol quality.
- Definition:* Conforms to ISO/IEC 16022 symbol quality grading (A,B,C,D).
- Serial Cmd:* <**K800**,output on symbol contrast,symbol contrast threshold,output on print growth,print growth threshold,output on axial non-uniformity,axial non-uniformity threshold,output on UEC,**UEC threshold**>
- Default:* **Grade C**
- Options:* 0 = Grade A
1 = Grade B
2 = Grade C
3 = Grade D

Diagnostics Output 1

Note: **Output On** under **Output 1 Parameters** must be set to **Diagnostic Warning** for this output to function.

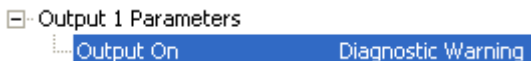

Under **Output 1 Parameters**, expand the **Diagnostics** tree.



Serial Cmd: <K790,unused 1,service unit>

Default: 0

Options: 0 = Disabled

Service Unit

When **Diagnostic Warning** is enabled, the **Output On** configuration has no effect. The output will remain active as long as one of the diagnostic warning conditions is met. The output will become inactive once it detects that there are no diagnostic warning conditions.

Definition: Allows the user to set up the output to toggle to active when the service timer has expired. This condition will only be held for one service timer click.

Note: This feature cannot be used if the reader is in a **Continuous Read** mode.

Serial Cmd: <K790,unused 1,service unit>

Default: 0

Options: 0 = Disabled 1 = Enabled

Configurable Output 2

Note: Output 2 has the same parameters and default settings as Output 1.

[-] Output 2 Parameters	
Output On	Symbol Quality
Output State	Normally Closed
Pulse Width	5
Output Mode	Pulse
+ Trend Analysis	
+ Symbol Quality (ISO/IEC 16022)	
+ Diagnostics	

Serial Cmd: <K811,output on,output state,pulse width,output mode>

Trend Analysis Output 2

Note: Output On under Output 2 Parameters must be set to Trend Analysis for this output to function.

[-] Output 2 Parameters	
Output On	Trend Analysis

Serial Cmd: <K781,trend analysis mode,trigger evaluation period,number to output on>

ISO/IEC 16022 Symbol Quality Output 2

Note: Output On under Output 2 Parameters must be set to Symbol Quality for this output to function.

[-] Output 2 Parameters	
Output On	Symbol Quality

Serial Cmd: <K801,output on symbol contrast,symbol contrast threshold,output on print growth,print growth threshold,output on axial non-uniformity,axial non-uniformity threshold,output on UEC,UEC threshold>

Diagnostics Output 2

Note: Output On under Output 2 Parameters must be set to Diagnostic Warning for this output to function.

[-] Output 2 Parameters	
Output On	Diagnostic Warning

Serial Cmd: <K791,unused 1,service unit>

Configurable Output 3

Note: **Output 3** has the same parameters and default settings as **Output 1** and **Output 2**.

[-] Output 3 Parameters	
[-] Output On	Mismatch or Noread
[-] Output State	Normally Closed
[-] Pulse Width	5
[-] Output Mode	Pulse
[+] Trend Analysis	
[+] Symbol Quality (ISO/IEC 16022)	
[+] Diagnostics	

Serial Cmd: <K812,output on,output state,pulse width,output mode>

Trend Analysis Output 3

Note: **Output On** under **Output 3 Parameters** must be set to **Trend Analysis** for this output to function.

[-] Output 3 Parameters	
[-] Output On	Trend Analysis

Serial Cmd: <K782,trend analysis mode,trigger evaluation period,number to output on>

ISO/IEC 16022 Symbol Quality Output 3

Note: **Output On** under **Output 3 Parameters** must be set to **Symbol Quality** for this output to function.

[-] Output 3 Parameters	
[-] Output On	Symbol Quality

Serial Cmd: <K802,output on symbol contrast,symbol contrast threshold,output on print growth,print growth threshold,output on axial non-uniformity,axial non-uniformity threshold,output on UEC,UEC threshold>

Diagnostics Output 3

Note: **Output On** under **Output 3 Parameters** must be set to **Diagnostic Warning** for this output to function.

[-] Output 3 Parameters	
[-] Output On	Diagnostic Warning

Serial Cmd: <K792,unused 1,service unit>

Power On/Reset Counts

Note: **Power On/Reset Counts** is a read-only command.

Power-On

Serial Cmd: <K406,power-on,resets,power-on saves,power-on flash saves>

Power-On uses a 16-bit counter that increments each time the reader is powered-on.

Resets

Serial Cmd: <K406,power-on,resets,power-on saves,power-on flash saves>

Resets uses a 16-bit counter that increments each time the reader is reset. This value is reset at power-on.

Power-On Saves

Serial Cmd: <K406,power-on,resets,power-on saves,power-on flash saves>

Power-On Saves uses a 16-bit counter that increments each time an reader setting is saved for power-on with a <Z> command.

Power-On Flash Saves

Serial Cmd: <K406,power-on,resets,power-on saves,power-on flash saves>

Power-On Flash Saves uses a 16-bit counter that increments each time an reader setting is saved to the customer parameter section of flash memory with a <Zc> command.

Time Since Reset

Note: Time Since Reset is a read-only command.

Hours

Serial Cmd: <K407,hours,minutes>

Default: **16-bit counter** (0 to 65535)

Hours uses a 16-bit counter that increments every 60 minutes.

Minutes

Serial Cmd: <K407,hours,minutes>

Default: **16-bit counter** (0 to 60)

Minutes uses a 16-bit counter that increments every 60 seconds.

Note: Time counts are reset at power-on, but not with an <A> or <Z> command.

Service Message

When **Service Message** is enabled, a message of up to 10 ASCII characters is sent whenever the system detects that the service timer's limit has been reached. The service timer is reset at power-on, meaning that the service timer's limit is the amount of time since last reset. Service timer increments can be set in seconds or minutes.

Serial Cmd: <**K409,status,service message,threshold,resolution**>

Default: **0**

Options: **0 = Disabled** 1 = Enabled

Service Message

Serial Cmd: <**K409,status,service message,threshold,resolution**>

Default: **SERVICE**

Options: An ASCII string between 1 and 10 characters.

Threshold

Serial Cmd: <**K409,status,service message,threshold,resolution**>

Default: **300** (5 minutes)

Options: 1 to 65535

Resolution

Serial Cmd: <**K409,status,service message,threshold,resolution**>

Default: **Seconds**

Options: **0 = Seconds** 1 = Minutes

User-Assigned Name

Definition: **User-Assigned Name** allows you to enter any string of ASCII characters to help you identify your reader. The user-assigned name is saved at power-on and custom defaults, and is stored as a “sticky” parameter so it cannot be defaulted without a **<Zrdall>** or **<K412d>** command.

Serial Cmd: **<K412,user-assigned name>**

Default: **MicroHAWK**

Options: ASCII string, up to 19 characters

Frame Information

Output Frame Number

Serial Cmd: <K734,output frame number,output coordinates>

Default: **Disabled**

Options: **0 = Disabled** 1 = Enabled

Disabled

When **Output Frame Number** is set to **Disabled**, the frame number is not output as part of the symbol data.

Enabled

When **Output Frame Number** is set to **Enabled**, the number of the frame in which the symbol was first decoded is attached to the symbol output information. The output format is “Fnnn”, where “nnn” is a 3-digit decimal value from 0 to 255. The frame number rolls over to 0 once it passes 255.

If this feature is enabled, the frame information will follow the symbol data, and it will precede any symbol quality data (if symbol quality settings are enabled—see **Symbol Quality Separator**). The symbol quality separator is located between the end of the already-formatted data and the “F” that precedes the frame number.

Output Coordinates

Serial Cmd: <K734,output frame number,output coordinates>

Default: **Disabled**

Options: **0 = Disabled** 1 = Enabled

Disabled

When **Output Coordinates** is set to **Disabled**, the coordinates are not output as part of the symbol data.

Enabled

When **Output Coordinates** is set to **Enabled**, the four sets of object coordinates for the first successfully decoded symbol are attached to the symbol data output in the following format:

“(nnn,mmm)”, where “nnn” is a 3-digit X-coordinate and “mmm” is a 3-digit Y-coordinate. The validation separator is located between the end of the already formatted data and the first coordinate point. The point with the lowest X + Y sum will be output first, followed by the next three points in a clockwise direction.

Example:

(032,040)(287,056)(287,279)(048,271)

Image Output

Usage: This feature allows the user to select what read cycle condition triggers the image file output.

Definition: Used to output an image file when a specified read cycle condition has been met, such as No-Read or Good Read. When the read cycle is complete, the normal read cycle output will occur, including any configured postamble or preamble data. The read cycle will check if image output is enabled, and if the specified read cycle condition has been met. If both these conditions are true, the image file will be output to the user-specified communication port in the user-specified image file format.

Serial Cmd: <**K739**,*image output mode,communication port,file format,JPEG quality*>

Default: **Disabled**

Options: **0 = Disabled**
1 = Good Read
2 = No-Read
3 = No-Read or Good Read
4 = Mismatch

Good Read

If a Good Read condition is met during the read cycle, the image file corresponding with the first Good Read will be output. The image file will immediately follow the read cycle output and postambles. For a Good Read condition to occur, all symbols in the read cycle must qualify.

No-Read

If a No-Read condition occurs during the read cycle, the image file corresponding with the first No-Read will output. The image file will immediately follow the read cycle output and postambles. There are conditions in which the read cycle may have a No-Read condition but the image will *not* be output. For example, if the read cycle is looking for two No-Read symbols in the same image capture but one is a Good Read, the image will not be output, because it is not considered a No-Read image.

No-Read or Good Read

If a No-Read condition or a Good Read condition occurs, the first image of either kind will be output.

Mismatch

If a Good Read occurs during the read cycle but the image is a Mismatch condition, the first Mismatch image will be output.

Communication Port

Definition: This setting selects the communication port through which the image file will be transferred to the host.

Serial Cmd: <K739,image output mode,communication port,file format,JPEG quality>

Default: Host

Options: 0 = Host 1 = TCP Port 1 2 = TCP Port 2

File Format

Definition: This setting selects the format of the image file to be output.

Note: If JPEG is the chosen image file format, the resolution of the image will be determined by the setting in the **JPEG Quality** field.

Serial Cmd: <K739,image output mode,communication port,file format,JPEG quality>

Default: JPEG

Options: 0 = Bitmap 1 = JPEG 2 = Binary

JPEG Quality

Definition: This setting determines the quality of JPEG image compression. The user may select a value from 1 (lowest) to 100 (highest).

Serial Cmd: <K739,image output mode,communication port,file format,JPEG quality>

Default: 90

Options: 1 to 100 (percent)

Image Output Example

The following example assumes that the reader is set to output on No-Read, and that it is in a rapid capture mode of 3 captures.

<i>Number of Symbols:</i>	1
<i>Frame # 1:</i>	No-Read
<i>Frame # 2:</i>	No-Read
<i>Frame # 3:</i>	No-Read
<i>Read Cycle Result:</i>	No-Read
<i>Output Frame:</i>	Frame # 1
<i>Number of Symbols:</i>	1
<i>Frame # 1:</i>	No-Read
<i>Frame # 2:</i>	No-Read
<i>Frame # 3:</i>	Good Read
<i>Read Cycle Result:</i>	Good Read
<i>Output Frame:</i>	None
<i>Number of Symbols:</i>	2
<i>Frame # 1:</i>	No-Read
<i>Frame # 2:</i>	No-Read
<i>Frame # 3:</i>	Good Read, Symbol # 1
<i>Read Cycle Result:</i>	No-Read
<i>Output Frame:</i>	Frame # 1

Database Identifier Output

Usage: Useful in keeping track of which database entries read which symbols.

Serial Cmd: <K759,status,separator>

Default: 0

Options: 0 = Disabled 1 = Enabled

Output Status

Disabled

When this command is disabled, no database identifier information will be output.

Enabled

When this command is enabled, the reader will append a two-digit number and the characters “DB” to the data output following the separator for each symbol decoded using **Configuration Database**. For example, if the separator is an underscore character and the second database entry reads a symbol encoded with “data capture” during the read cycle, the symbol data output will be “data capture_DB02”. If the database is not active, no identifiers will be attached to output.

Separator

Usage: The separator character separates the symbol data from the database identifier.

Serial Cmd: <K759,status,separator>

Default: <space>

Options: Any ASCII character.

Quality Output

Separator

Definition: The separator character separates quality output data from symbol data.

Serial Cmd: **<K704,separator,decodes per trigger status>**

Default: ,

Options: Any ASCII character.

Decodes per Trigger Status

Definition: When this feature is enabled, the reader enters a state where it processes frames as configured until the end of a read cycle, with or without a successful symbol decode. When the read cycle ends, the reader outputs any decoded symbol data along with the decodes per trigger count.

Serial Cmd: **<K704,separator,decodes per trigger status>**

Default: **0**

Options: **0 = Disabled** 1 = Enabled

EZ Trax Output

Usage: Useful for when you want to configure EZ Trax output using serial commands instead of the EZ Trax graphic interface.

Definition: When EZ Trax output is enabled, the imager will attempt to output all enabled EZ Trax options. EZ Trax will not function unless enabled.

Serial Cmd: <**K757,status,transfer port,image mode,image format,image quality,object info enable,grade enable**>

Default: **Disabled**

Options: **0 = Disabled** 1 = Enabled

Transfer Port

Definition: Selects the communication port that will be used to transfer image files.

Serial Cmd: <**K757,status,transfer port,image mode,image format,JPEG quality,object info enable,grade enable**>

Default: **RS-232**

Options: **0 = RS-232**
3 = Ethernet TCP Port 1
4 = Ethernet TCP Port 2

Host Port

Sends output using the current Host Port.

Image Mode

Definition: Determines which read cycle condition triggers image file output.

Serial Cmd: <**K757,status,transfer port,image mode,image format,image quality,object info enable,grade enable**>

Default: **Disabled**

Options: **0 = Disabled**
1 = Good Read
2 = No Read
3 = No Read and Good Read
4 = Mismatch

Good Read

Outputs the first Good Read image in the read cycle. The image file will immediately follow the symbol data.

Object Info Enable

Definition: If a symbol is decoded during an image capture, the symbol type and other supplementary symbol information is also included.

Serial Cmd: <K757,status,transfer port,image mode,image format,image quality,**object info enable,grade enable**>

Default: **Disabled**

Options: **0 = Disabled** 1 = Enabled

Grade Enable

Definition: Symbol quality information will be output in the form of an abbreviated identifier for each read cycle.

Serial Cmd: <K757,status,transfer port,image mode,image format,image quality,object info enable,**grade enable**>

Default: **Disabled**

Options: **0 = Disabled** 1 = Enabled

Image Push to Host

Definition: **Image Storage Status** determines whether or not **Image Logging** is active.

Note: Only images that have been processed by the decoder will be saved. If Image Storage Status and **RAM Drive Size in MB** in <K764> are switched from **Disable** to **Enable**, a cold boot of the reader will be required in order to create the required RAM Drive, and it will take additional time for the reader to re-initialize. Switching from Enable to Disable does not require a cold boot.

Serial Cmd: <K763,*image storage status*,*stored image type*,*image storage*,*image file format*,*image quality*,*image scale*,*file save options*>

Default: **Disabled**

Options: **0 = Disabled**
1 = Enabled

Stored Image Type

Definition: **Stored Image Type** defines what kind of image you want to log in a read cycle.

Serial Cmd: <K763,*image storage status*,**stored image type**,*image storage*,*image file format*,*image quality*,*image scale*,*file save options*>

Default: **No Read**

Options: 1 = Good Read
2 = No Read
3 = Good Read + No Read
4 = Match
8 = Mismatch
12 = Match + Mismatch
15 = Good Read + No Read + Match + Mismatch

Image Storage

Definition: **Image Storage** defines which image will be stored within a read cycle.

- **Good Read/Match/Mismatch:** First qualified image or all qualified images.
- **No Read:** First image or all images that have an IP report.

Serial Cmd: <K763,*image storage status*,*stored image type*,**image storage**,*image file format*,*image quality*,*image scale*,*file save options*>

Default: **First Image in a Read Cycle**

Options: **0 = First Image in a Read Cycle**
1 = All Images in a Read Cycle

Image File Format

Definition: **Image File Format** defines the image format you want to use.

Serial Cmd: <K763,image storage status,stored image type,image storage,**image file format**,image quality,image scale,file save options>

Default: **PNG**

Options: **0 = PNG**
1 = JPG

Image Quality

Definition: **Image Quality** defines the amount of image compression you want the image to have.

Serial Cmd: <K763,image storage status,stored image type,image storage,image file format,**image quality**,image scale,file save options>

Default: **90**

Options: 1 to 100

Image Scale

Definition: **Image Scale** defines the size you want the image to be.

Serial Cmd: <K763,image storage status,stored image type,image storage,image file format,image quality,**image scale**,file save options>

Default: **Full**

Options: **0 = Full**
1 = 1/4th
2 = 1/8th

File Save Options

Definition: **File Save Options** determines which files you want to save.

Serial Cmd: <K763,image storage status,stored image type,image storage,image file format,image quality,image scale,**file save options**>

Default: **Image**

Options: **1 = Image**
2 = Read Cycle Report
3 = Image + Read Cycle Report

Image Push to Host Detailed Setup

Image Storage Location

Definition: Defines where the saved image is going to be stored.

Note: When saving images to **RAM**, the system is limited to the actual RAM space available in the system. The number of images that can be saved depends on the **Max RAM Drive Size**. The actual system path is **/imagesd0/Images/**. When saving images to **FTP**, the path is **<last 6 digits of device's MAC Address>_Images/** on the host FTP director. Note that the FTP server needs to grant the user with create directory rights as the system will need to create a directory on the FTP server to store all uploaded images.

File save scheme: The image file will be posted with its system reset count, followed by its read cycle i.d., followed by its image i.d., followed by its stored image type defined in **<K763>**, as follows:

<last 6 digits of device's MAC Address>_<system total reset count>_<read cycle id>_<image id>_<save image type>.{png, jpg}

<last 6 digits of device's MAC Address>_<system total reset count>_<read cycle id>_<image id>_readreport.xml

Serial Cmd: **<K764,image storage location,FTP host info,transfer optimization,RAM drive size in MB,save image until,action at image storage limit>**

Default: **RAM**

Options: **0 = RAM**
1 = FTP

FTP Host Info

Definition: **mscan|pass@192.168.188.1:21** signifies a the user with **mscan** at **192.168.188.1** FTP server on port **21** with **pass** as the FTP login password.

Note: If port is not defined with the FTP server address, it will default to port 21.

Serial Cmd: **<K764,image storage location,FTP host info,transfer optimization,RAM drive size in MB,save image until,action at image storage limit>**

Default: **"user|pass@xxx.xxx.xxx.xxx:21"**

Options: Maximum 255 characters including the characters **"|"**, **"@"**, and **":"**.

Transfer Optimization

Definition: Transfer Optimization defines how the image is going to be stored in triggered captured modes.

Serial Cmd: <K764,image storage location,FTP host info,transfer optimization,RAM drive size in MB,save image until,action at image storage limit>

Default: Speed

Options: 0 = Speed (Lossy)
1 = Accuracy (Lossless)

Speed (Lossy)

Images will be saved when possible. Some images may be dropped.

SOR = Start of Read Cycle

EOR = End of Read Cycle

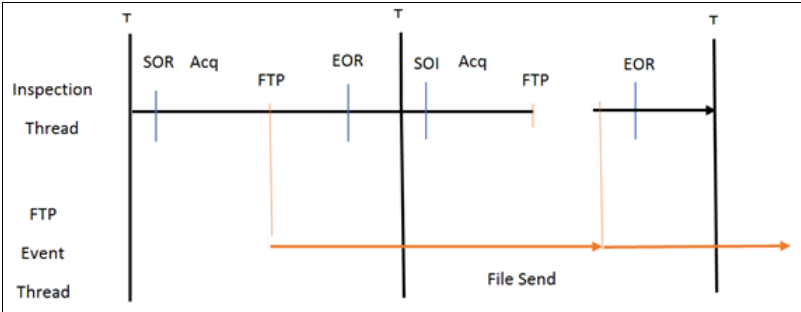

Accuracy (Lossless)

Every image in read cycle is transferred. The read cycle may be delayed due to image saving since each transfer will need to be finished before the end of the read cycle.

SOR = Start of Read Cycle

EOR = End of Read Cycle

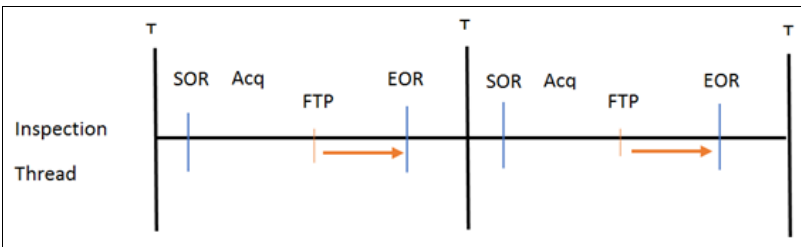

RAM Drive Size in MB

Definition: This defines the maximum RAM Drive size on the system. It is also limited to the memory available on the system and affects the max. rapid image count in **<K241>** since the onboard memory may be taken up by the RAM Drive. Images may not be saved if the RAM Drive is not large enough to store all the images in the current read cycle and if **Image Storage Location** is set to **FTP** with **Image Save Mode** set to **Speed**. If Image Storage Location is set to FTP with Image Save Mode set to **Accuracy**, all images in the read cycle will be transferred to the FTP host but the read cycle may be delayed.

Serial Cmd: **<K764,image storage location,FTP host info,transfer optimization,RAM drive size in MB,save image until,action at image storage limit>**

Default: **20**

Options: 1 to 50

Save Image Until

Definition: This defines how long the image will be stored in the system when the **Image Storage Location** is **RAM**.

If set to **New Read Cycle**, the saved image will be erased upon entering the next read cycle.

If set to **System Reset**, the saved image will be erased upon the next system reset.

Serial Cmd: **<K764,image storage location,FTP host info,transfer optimization,RAM drive size in MB,save image until,action at image storage limit>**

Default: **New Read Cycle**

Options: **0 = New Read Cycle**
1 = System Reset

Action at Image Storage Limit

Definition: This defines what to do when **Action at Storage Full** is reached and when images are saved on **RAM**. When this setting is set to **Erase Oldest First**, the oldest images in the current read cycle will be erased.

Serial Cmd: **<K764,image storage location,FTP host info,transfer optimization,RAM drive size in MB,save image until,action at image storage limit>**

Default: **Stop**

Options: **0 = Stop**
1 = Erase Oldest First

8 *Symbol Quality*

Contents

- Symbol Quality by ESP..... 8-2
- Symbol Quality Serial Commands 8-3
- Overview of Symbol Quality..... 8-4
- Symbol Quality Separator/Data Matrix Output Mode..... 8-8
- ISO/IEC 16022 Symbol Quality Output..... 8-10
- ISO/IEC 16022 Symbol Quality Output by ESP..... 8-12
- Microscan Symbol Quality Output 8-13
- Microscan Symbol Quality Output by ESP 8-16

This section describes parameters that, when enabled, will output detailed symbol quality evaluations.

Symbol Quality by ESP

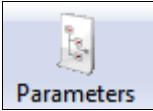

Click the **Parameters** button and then the **Symbol Quality** tab.

Parameters	ESP Values
[-] Symbol Quality	
[-] Global	
Symbol Quality Separator	SP
Output Mode	Grade
[-] Data Matrix	
[-] ISO/IEC 16022 Parameters	
Symbol Contrast	Disabled*
Print Growth	Disabled*
Axial Non-uniformity	Enabled
Unused ECC	Disabled
[+] Grading	

To open nested options, **single-click** the +.

To change a setting, **double-click** the setting and use your cursor to scroll through the options.

Symbol Quality Serial Commands

Symbol Quality Separator / Output Mode	<K708,symbol quality separator,Data Matrix output mode>
ISO/IEC 16022 Symbol Quality Output	<K709,symbol contrast,print growth,axial non-uniformity,unused ECC>
Microscan Symbol Quality Output	<K710,percent cell damage,total read time,capture time,locate time,decode time,pixels per element,ECC level,matrix size,quiet zone,symbol angle>

Overview of Symbol Quality

Information about symbol quality and timing can be appended to symbol data by enabling specific evaluation parameters. The order in which these values are appended corresponds directly to the order in which they appear in **ESP's Symbol Quality** tree control.

Symbol Quality parameters are separated into ISO/IEC 16022 Symbol Quality Output and Microscan Symbol Quality Output.

Total Read Time, Symbol Quality Separator, and Output Mode are common to both ISO/IEC 16022 and Microscan Grading Parameters.

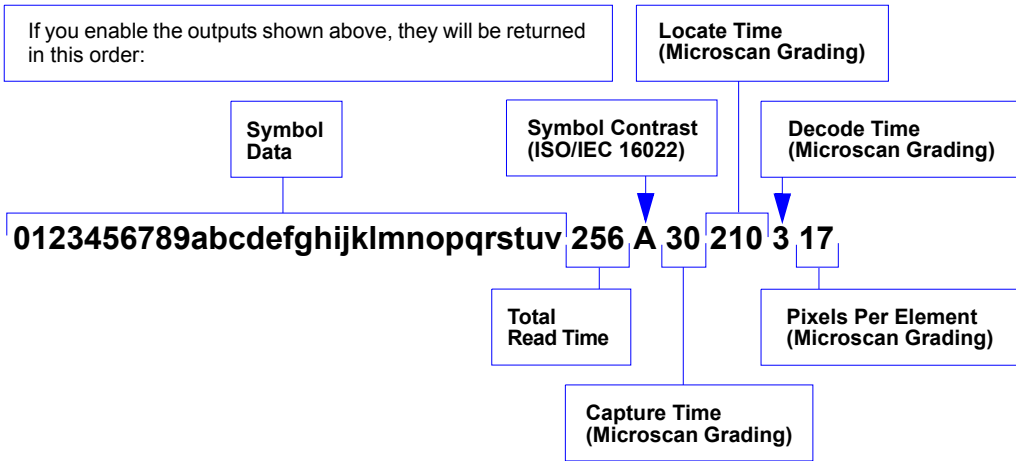
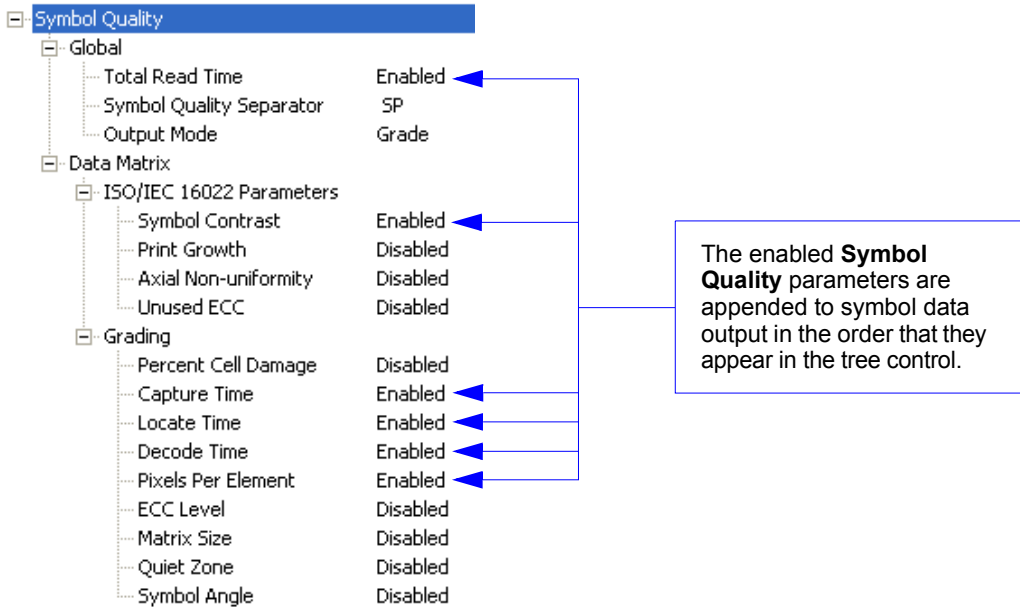

Report Tab

The **Report** tab allows the user to initiate **Data Matrix Grading** and to generate and save grading reports.

To save the report as a PDF file, an HTML file, a CSV file, or an RTF file, click the **Save Report** button.

Reports appear in the viewing area underneath the **Data Matrix Grading** and **Save Report** buttons.

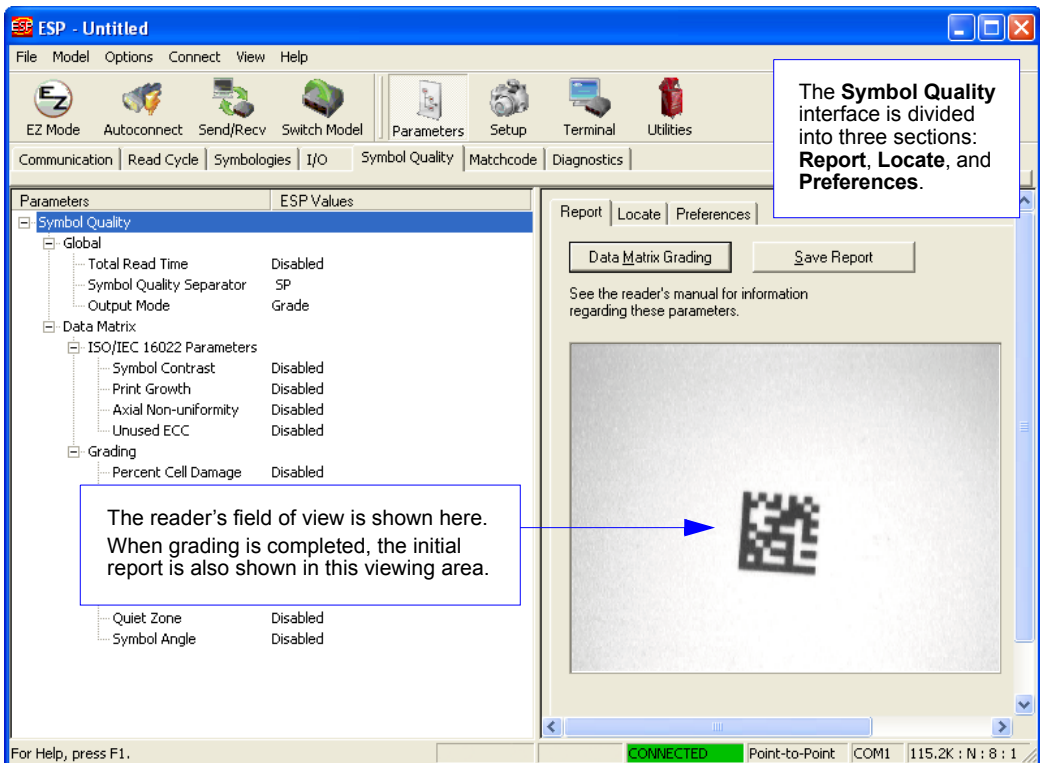

Locate Tab

The **Locate** tab allows the user to determine the position of the symbol within the reader's field of view, and to optimize the reader's camera settings for symbol quality evaluation.

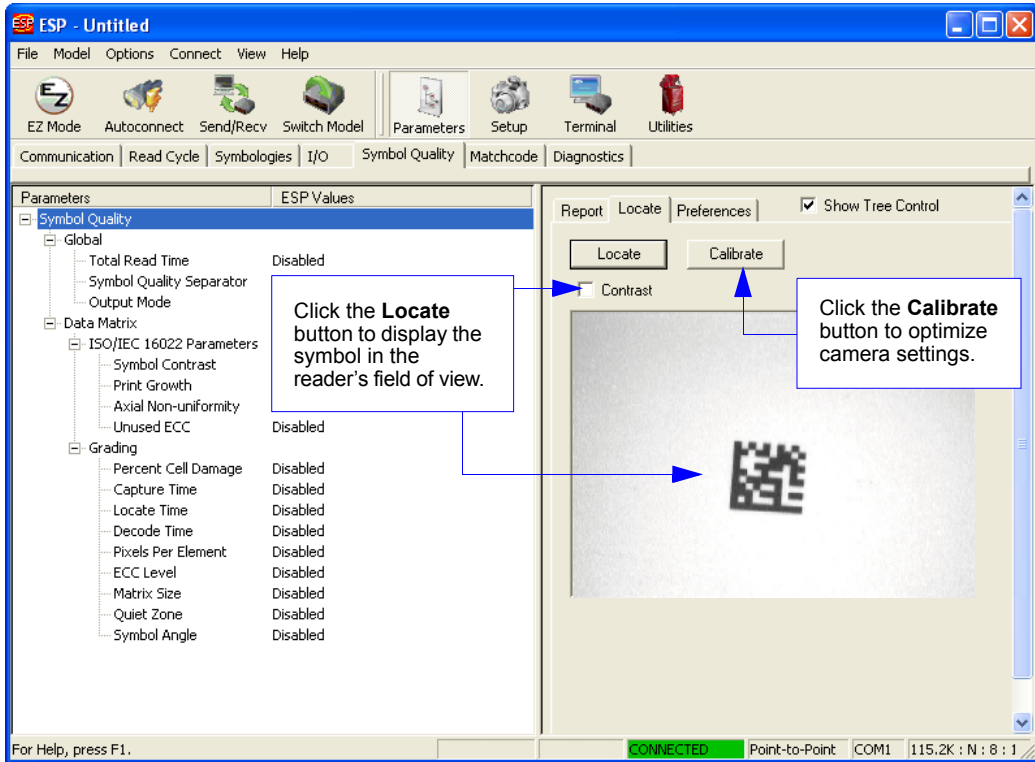

Preferences Tab

The **Preferences** tab allows the user to set defaults that are automatically activated when grading is completed. For this reason, the user is advised to set preferences before performing grading.

The screenshot shows the Preferences dialog box with the following sections and callouts:

- Report | Locate | Preferences |** (Tabs) and Show Tree Control
- Fields for report:**
 - Operator Name: J. Doe (Callout: This information is appended at the bottom of the report.)
 - Company Name: XYZ Corp.
- Saved Options:**
 - Show Report Options dialog during 'Save Report'.
 - Default Report Type: PDF Files (*.pdf) (Callout: Choose the default report type to be generated when you click **Save Report** on the **Report** tab. Check **Autofit Content** to ensure that saved PDF report content will fit on a single page.)
 - Autofit Content Low Graphic HTML Append to file
 - Store Report without file path prompt (Callout: Typically you will be asked where you wish to store your report. If you do not want to be prompted to choose a file path, click **Store Report without file path prompt**.)
 - Use symbol data for file name
 - Default Path: C:\Documents and Settings\symbol grades
 - Automatically open generated report Print after saving
 - Include Image (Callout: Click the **Include Image** check box to output the captured symbol image with your saved report as a Bitmap or JPEG image file.)
 - Bitmap JPEG
 - JPEG Image Quality: 100 (1 - 100)
- Overall Grade Based On:**
 - Symbol Contrast
 - Print Growth
 - Axial Nonuniformity
 - Unused ECC
 - Enable UII Parsing (Callout: Enables ESP to parse UII symbol data into the correct fields and output order defined by the U.S. Department of Defense IUID initiative.)
- Buttons:**
 - Default Settings (Callout: Returns all settings to default.)
 - Revert Settings (Callout: Returns all settings to most recent.)

Symbol Quality Separator/Data Matrix Output Mode

Symbol Quality Separator applies to both Symbol Quality groups: ISO/IEC 16022 Symbol Quality Output and Microscan Symbol Quality Output.

Symbol Quality Separator

Definition: Inserts a separator between each enabled field of the symbol quality output.

Serial Cmd: <K708,**symbol quality separator,output mode**>

Default: <SP> (space character)

Options: Any ASCII character.

Symbol Quality Separator by ESP

The screenshot shows a configuration window with a tree view on the left and a calculator keypad on the right. The tree view has a 'Parameters' tab and an 'ESP Values' sub-tab. Under 'Symbol Quality', there is a 'Global' group containing 'Total Read Time' (Disabled), 'Symbol Quality Separator' (SP), and 'Output Mode' (Grade). A blue box highlights the 'Symbol Quality Separator' field. A callout box points to this field with the text: "When you double-click on the default separator SP, the **Symbol Quality Separator Calculator** appears. Use the calculator keypad for one-click separator configuration." The calculator keypad is a grid of characters: NUL, SOH, STX, ETX, EOT, ENQ; ACK, BEL, BS, HT, LF, VT; FF, CR, SO, SI, DLE, DC1; DC2, DC3, DC4, NAK, SYN, ETB; CAN, EM, SUB, ESC, FS, GS; RS, US, SP. Below the keypad, it says "Click 'Delete' to remove characters."

Data Matrix Output Mode

Note: Output Mode applies to ISO/IEC 16022 symbol quality parameters.

Definition: Output Mode specifies how the four output parameters, if enabled, are formatted.

Serial Cmd: <**K708**,symbol quality separator,**output mode**>

Default: **Grade**

Options: **0 = Grade** 1 = Value

Grade

If in **Grade Mode**, a grade (A,B,C,D) is appended to the symbol data.

Value

If in **Value Mode**, the calculated value for the given parameter is appended to the symbol data.

ISO/IEC 16022 Symbol Quality Output

Symbol Quality Parameters for Data Matrix symbols specified by ISO/IEC 16022.

Symbol Contrast

Usage: Lets the user know if contrast settings are less than acceptable.

Definition: All the pixels that fall within the area of the test symbol, including its required zone, will be sorted by their reflectance values to select the darkest 10% and the lightest 10% of the pixels. The arithmetic mean of the darkest and the lightest pixels is calculated and the difference of the two means is the Symbol Contrast.

(ANSI) Symbol Contrast grading is defined this way:

A (4.0) if SC > 70%

B (3.0) if SC > 55%

C (2.0) if SC > 40%

D (1.0) if SC > 20%

F (0.0) if SC < 20%

If enabled, the symbol contrast is appended to the symbol data according to the **ISO/IEC 16022 Symbol Quality Output Mode** setting.

Serial Cmd: <**K709**,symbol contrast,print growth,axial non-uniformity,UEC>

Default: **Disabled**

Options: **0 = Disabled** 1 = Enabled

Print Growth

Definition: The extent to which dark or light markings appropriately fill or exceed their module boundaries. These values are determined by counting pixels in the clock pattern of the binary digitized image, then comparing it to a nominal value and minimum and maximum values. The print growth grade is defined in this way:

A (4.0) if $-.050 < PG < 0.50$

B (3.0) if $-.070 < PG < 0.70$

C (2.0) if $-.085 < PG < 0.85$

D (1.0) if $-.10 < PG < 1.00$

F (0.0) if $PG < -1.00$ or $PG > 1.00$

If enabled, the print growth is appended to the symbol data according to the **ISO/IEC 16022 Symbol Quality Output Mode** setting.

Serial Cmd: <**K709**,symbol contrast,print growth,axial non-uniformity,UEC>

Default: **Disabled**

Options: **0 = Disabled** 1 = Enabled

Axial Non-Uniformity (Data Matrix Only)

Definition: Axial non-uniformity is a measure of how much the sampling point spacing differs from one axis to another, namely $AN = \text{abs}(XAVG - YAVG) / ((XAVG + YAVG)/2)$ where $\text{abs}()$ yields the absolute value. If a symbology has more than two major axes, then AN is computed for those two average spacings which differ the most. (ANSI) axial non-uniformity grading is defined this way:

A (4.0) if $AN < .06$

B (2.0) if $AN < .08$

C (2.0) if $AN < .10$

D (1.0) if $AN < .12$

F (0.0) if $AN > .12$

If enabled, the axial non-uniformity is appended to the symbol data according the **ISO/IEC 16022 Symbol Quality Output Mode** setting.

Serial Cmd: `<K709,symbol contrast,print growth,axial non-uniformity,UEC>`

Default: Disabled

Options: 0 = Disabled 1 = Enabled

Unused Error Correction (Data Matrix Only)

Definition: The correction capacity of Reed-Solomon decoding is expressed in the equation: $e + 2d < d - p$, where e is the number of erasures, d is the number of error correction code words, and p is the number of code words reserved for error detection.

A (4.0) if $UEC > .62$

B (3.0) if $UEC > .50$

C (2.0) if $UEC > .37$

D (1.0) if $UEC > .25$

F (0.0) if $UEC < .25$

If enabled, the UEC is appended to the symbol data according to the **ISO/IEC 16022 Symbol Quality Output Mode** setting.

Serial Cmd: `<K709,symbol contrast,print growth,axial non-uniformity,UEC>`

Default: Disabled

Options: 0 = Disabled 1 = Enabled

ISO/IEC 16022 Symbol Quality Output by ESP

ESP's **Symbol Quality** interface allows you to evaluate Data Matrix symbols for compliance with ISO/IEC 16022 requirements.

First, determine which ISO/IEC 16022 Parameters you need to evaluate, using the **Symbol Quality** tree control.

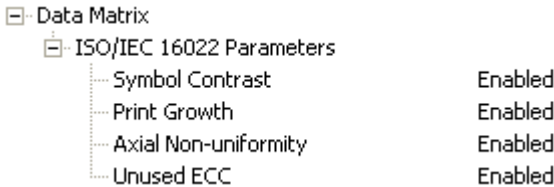

Once you have set these Data Matrix evaluation parameters, go to the **Preferences Tab** and set your Data Matrix Grading Report output preferences.

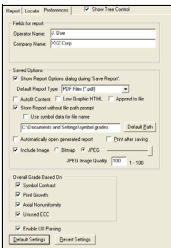

After your output preferences are set, click the **Data Matrix Grading** button.



There will be a wait of a few seconds, and then the evaluation results will appear in the **Symbol Quality** view, in a format similar to the one shown below.

Data Matrix Grading Report										GRADE
ISO/IEC 16022:	Symbol Contrast	=	80 %	Dx	-	54 %	Dnom	-	50 %	A
	Print Growth	=	0.26	Dy	-	54 %	Dmax	=	65 %	A
	Axial Nonuniformity	=	0.00	Xavg	-	13.2	Dmin	-	35 %	A
	Unused ECC	=	100 %	Yavg	-	13.1	Eact	-	0	A
GRADING:	% Cell Damage	=	0 %	Emax	-	10				
	Total Read Time	=	99 ms							
	Capture Time	=	65 ms							
	Locate Time	=	27 ms							
	Decode Time	=	7 ms							
	Pixels/Element	=	13.1							
	ECC Level	=	200							
	Matrix Size	=	14x14							
Quiet Zone	=	PASS								

If you want to view the results in a report format, click the **Save Report** button. The report will be output in the format you chose in the **Preferences** dialog.



Microscan Symbol Quality Output

Percent Cell Damage (Data Matrix Only)

Definition: When this feature is enabled, the cell damage percentage is appended to data output.

Serial Cmd: <**K710**,percent cell damage,total read time,capture time,locate time,decode time,pixels per element,ECC level,matrix size,quiet zone,symbol angle>

Default: Disabled

Options: 0 = Disabled 1 = Enabled

Total Read Time

Definition: The time that transpires between the image capture and the output of the decoded data, including locate time.

When enabled, the total read time is appended to the symbol data.

Serial Cmd: <**K710**,percent cell damage,**total read time**^a,capture time,locate time,decode time,pixels per element,ECC level,matrix size,quiet zone,symbol angle>

Default: Disabled

Options: 0 = Disabled 1 = Enabled

a. **Total Read Time** applies globally to all three Symbol Quality standards.

Capture Time

Definition: Capture time (in milliseconds) is a fixed “overhead” that includes the time of capture and transfer of the image.

When enabled, the capture time is appended to the symbol data.

Serial Cmd: <**K710**,percent cell damage,total read time,**capture time**,locate time,decode time,pixels per element,ECC level,matrix size,quiet zone,symbol angle>

Default: Disabled

Options: 0 = Disabled 1 = Enabled

Locate Time

Definition: The time in milliseconds from the start of image processing until the symbol has been located and is ready to be decoded.

When enabled, the locate time is appended to the symbol data.

Serial Cmd: <**K710**,percent cell damage,total read time,capture time,**locate time**,decode time,pixels per element,ECC level,matrix size,quiet zone,symbol angle>

Default: Disabled

Options: 0 = Disabled 1 = Enabled

Quiet Zone (Data Matrix Only)

Definition: When this feature is enabled, the size of the quiet zone is evaluated and a PASS or FAIL message is appended to the symbol data.

Serial Cmd: <K710,percent cell damage,total read time,capture time,locate time,decode time,pixels per element,ECC level,matrix size,**quiet zone**,symbol angle>

Default: Disabled

Options: 0 = Disabled 1 = Enabled

Symbol Angle (Data Matrix Only)

Definition: When this feature is enabled, the symbol orientation is appended to data output as a degree value representing the angle of the Data Matrix symbol's L-shaped finder pattern relative to the reader.

Serial Cmd: <K710,percent cell damage,total read time,capture time,locate time,decode time,pixels per element,ECC level,matrix size,**quiet zone**,**symbol angle**>

Default: Disabled

Options: 0 = Disabled 1 = Enabled

Microscan Symbol Quality Output by ESP

ESP's **Symbol Quality** interface allows you to evaluate Data Matrix symbols for compliance with a rigorous set of standards, such as Locate Time, Capture Time, and Decode Time.

First, determine which parameters you want to evaluate, using the **Symbol Quality** tree control.

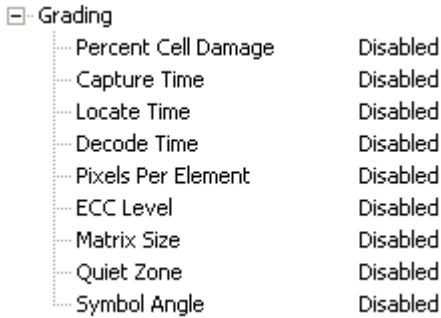

Once you have set these Data Matrix evaluation parameters, go to the **Preferences Tab** and set your Data Matrix Grading Report output preferences.

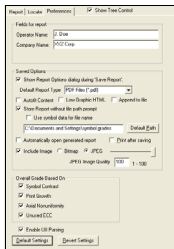

After your output preferences are set, click the **Data Matrix Grading** button.



There will be a wait of a few seconds, and then the evaluation results will appear in the **Symbol Quality** view, in a format similar to the one shown below.

Data Matrix Grading Report				GRADE	
ISO/IEC 16022:	Symbol Contrast	= 80 %			A
	Print Growth	= 0.26	Dx - 51 %	Dnom - 50 %	A
			Dy - 54 %	Dmax - 65 %	
			Dmin - 35 %		
	Axial Nonuniformity	= 0.00	Xavg - 13.2		A
			Yavg - 13.1		
	Unused ECC	= 100 %	Eact - 0		A
			Emax - 10		
GRADING:	% Cell Damage	= 0 %			
	Total Read Time	= 99 ms			
	Capture Time	= 65 ms			
	Locate Time	= 27 ms			
	Decode Time	= 7 ms			
	Pixels/Element	= 13.1			
	ECC Level	= 200			
	Matrix Size	= 14x14			
	Quiet Zone	= PASS			

If you want to view the results in a report format, click the **Save Report** button. The report will be output in the format you chose in the **Preferences** dialog.

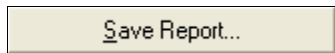

9 Matchcode

Contents

Matchcode by ESP	9-2
Matchcode Serial Commands	9-3
Overview of Matchcode	9-4
Matchcode Type	9-5
Sequence Step Interval	9-10
Match Replace.....	9-11
Mismatch Replace.....	9-12
New Master Pin	9-13

This section explains the MicroHAWK ID's matchcode output functions and the master symbol database setup.

Matchcode by ESP

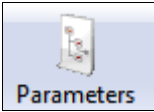

Click the **Parameters** button and then the **Matchcode** tab.

Parameters	ESP Values
<input type="checkbox"/> Matchcode	
Matchcode Type	Disabled
Sequential Matching	Increment
Match Start Position	0
Match Length	1
Wild Card	*
Sequence on No Read	Enabled
Sequence on Mismatch	Disabled
Sequence Step Interval	1
New Master Pin	Disabled*
<input type="checkbox"/> Match Replace	Disabled*
Replacement String	Enabled
<input type="checkbox"/> Mismatch Replace	Disabled
Replacement String	MISMATCH

To open nested options, **single-click** the +.

To change a setting, **double-click** the setting and use your cursor to scroll through the options.

Matchcode Serial Commands

Matchcode	<K223,matchcode type,sequential matching,match start position,match length,wildcard character,sequence on No-Read,sequence on mismatch>
Number of Master Symbols	<K224,number of master symbols>
New Master Pin	<K225,status>
Sequence Step Interval	<K228,sequence step interval>
Master Symbol Data	<K231,index,master symbol data>
Match Replace	<K735,status,match replacement string>
Mismatch Replace	<K736,status,mismatch replacement string>

Overview of Matchcode

- Definition:* **Matchcode** allows the user to store master symbol data in the reader's memory, compare that data against other symbol data, and define how symbol data and/or discrete signal output will be directed. A master symbol database can be set up for up to 10 master symbols. **Note: Matchcode** will function with multiple symbols; however, if **Matchcode Type** is set to **Sequential** or if **Triggering Mode** is set to **Continuous Read 1 Output**, the reader will behave as if **Number of Symbols** were set to **1**, regardless of the user-defined configuration.
- Usage:* Matchcode is used in applications to sort, route, or verify data based on matching the specific symbol in a variety of ways as defined in this section. For example, a manufacturer might sort a product based on dates that are embedded in the symbol.

Steps for Entering and Using Master Symbols

1. Set **Triggering Mode** to **External** or **Serial**.
2. Choose the method of symbol comparison that fits your application.
3. Define the output you want to achieve with your matchcode setup:
 - a. Symbol data output
 - b. Discrete output
4. Select the number of master symbols you want to create.
5. Decide which of 4 ways you want to enter your master symbol(s):
 - a. Use **ESP** to type master symbol data directly.
 - b. Send a serial command with symbol data in the form of **<M231, master symbol#, data>**.
 - c. Send a **<G>** (**Read Next Symbol as Master Symbol**) command.
 - d. Enable the **New Master Pin** command and activate the discrete input to store the next symbol read as the master symbol.

Matchcode Type

Definition: Allows the user to choose the way that master symbols will be compared with subsequently read symbols.

Note: First set **Triggering Mode** to **External** or **Serial**.

ESP:

Parameters	
[-] Matchcode	
Matchcode Type	Disabled*
Sequential Matching	Disabled*
Match Start Position	Enabled
Match Length	Wild Card
Wild Card	Sequential
Sequence on Noread	Enabled
Sequence on Mismatch	Disabled
New Master Pin	Disabled
[-] Match Replace	Disabled
Replacement String	MATCH
[-] Mismatch Replace	Disabled
Replacement String	MISMATCH

Serial Cmd: *<K223,matchcode type,sequential matching,match start position,match length,wild card character,sequence on No-Read,sequence on mismatch>*

Default: **Disabled**

Options: **0 = Disabled**
 1 = Enabled
 2 = Wild Card
 3 = Sequential

Disabled: Has no effect on operations.

Enabled: Instructs the reader to compare symbols or portions of symbols with the master symbol.

Wild Card: Allows the user to enter user-defined wild card characters in the master symbol.

Sequential: Instructs the reader to sequence after each match (numeric only) and compare symbols or portions of symbols for sequential numbers.

Note: If **Matchcode Type** is set to **Sequential**, the reader will behave as if **Number of Symbols** were set to **1**, regardless of the user-defined configuration.

Sequential Matching

- Usage:** Useful in tracking product serial numbers that increment or decrement sequentially.
- Definition:** With Sequential enabled, Sequential Matching determines if a count is in ascending (incremental) or descending (decremental) order.
- Serial Cmd:** <**K223**,*matchcode type*,**sequential matching**,*match start position*,*match length*,*wild card character*,*sequence on No-Read*,*sequence on mismatch*>
- Default:** **Increment**
- Options:** **0 = Increment** 1 = Decrement

Match Start Position

- Usage:** **Match Start Position** is useful in defining specific portions of a symbol for comparison. For example, if a symbol contains a part number, manufacturing date, and lot code info, but you are only interested in the part number information, you can set the reader to sort only the part number and ignore the other characters.
- Definition:** **Match Start Position** determines the portions of symbols that will be matched by defining the first character in the symbol (from left to right) that will be compared with those of the master symbol, when **Matchcode Type** is set to **Enabled** or **Sequential**.
- Function:** For example, if **Match Start Position** is set to **3**, the first 2 characters read in the symbol will be ignored and only the 3rd and subsequent characters to the right will be compared, up to the number of characters specified by **Match Length**.
- Serial Cmd:** <**K223**,*matchcode type*,*sequential matching*,**match start position**,*match length*,*wild card character*,*sequence on No-Read*,*sequence on mismatch*>
- Default:** **0**
- Options:** 0 to 3000

Note: **Match Start Position** must be set to **1** or greater to enable this feature. A **0** setting will disable this feature.

Match Length

- Usage:** *Example:* If **Match Length** is set to **6** in a 10-character symbol, and **Match Start Position** is set to **2**, only the 2nd through 7th characters (from left to right) will be compared.
- Definition:** Defines the length of the character string that will be compared with that of the master symbol when **Match Start Position** is set to **1** or greater. When **Match Start Position** is set to **0**, no comparison will occur.
- Serial Cmd:** <**K223**,*matchcode type*,*sequential matching*,*match start position*,**match length**,*wild card character*,*sequence on No-Read*,*sequence on mismatch*>
- Default:** **1**
- Options:** 1 to 3000

Wild Card Character

- Usage:** *Example:* With **Wild Card Character** defined as the default asterisk, defining **CR*34** as the master symbol will result in matches for CR134 and CR234, but not CR2345. Entering URGENT** as your master symbol will result in matches for URGENT, URGENT1, and URGENT12 but not for URGENT123. This means any wild cards appended to the master symbol data will result in matches of symbols in variable lengths up to the master symbol lengths but not over. However, wild cards in the beginning or center of a symbol (e.g., UR**NT) do not allow for variable symbol lengths.
- Definition:** Wild Card Character allows a user to define a wild card character as part of the master symbol.
- Serial Cmd:** <**K223**,*matchcode type, sequential matching, match start position, match length, wild card character, sequence on No-Read, sequence on mismatch*>
- Default:** * (asterisk)
- Options:** Any ASCII character.

Sequence on Mismatch

Note: Matchcode must be set to **Sequential** for this command to function.

Usage: Enable this parameter if every trigger event should have a decode *and* more than one consecutive mismatch may occur.

Disable this parameter if every trigger event should have a decode but no more than one consecutive mismatch may occur.

Definition: When set to Enabled, the master symbol sequences on every decode, match, or mismatch.

When set to Disabled, the master symbol will not sequence whenever consecutive mismatches occur.

Serial Cmd: <**K223**,matchcode type,sequential matching,match start position,match length,wild card character,sequence on No-Read,**sequence on mismatch**>

Default: Disabled

Options: 0 = Disabled 1 = Enabled

The reader will sequence the master to one more or one less than the decoded symbol.

As an example of **Sequence on Mismatch Enabled**, consider the following decodes:

Master Symbol	Decoded Symbol	Master Symbol after Decode
001	001	002
002	002	003
003	abc	004 (sequenced on mismatch)
004	004	005
005	def	006 (sequenced on mismatch)
006	ghi	007 (sequenced on mismatch)
007	007	008

As an example of **Sequence on Mismatch Disabled**, consider the following decodes:

Master Symbol	Decoded Symbol	Master Symbol after Decode
001	001	002
002	002	003
003	abc	004 (sequenced because of previous match)
004	004	005
005	def	006 (sequenced because of previous match)
006	ghi	006 (not sequenced)
006	006	007

Sequence Step Interval

Usage: Useful in applications in which it is desirable to count by intervals other than 1.

Definition: Sequencing in Matchcode operations can occur in steps from 1 to 32,768.
Sequencing performs like a mechanical counter by displaying positive integers and a specific number of digits after roll-overs. For example, 000 - 3 = 997 (not -3) and 999 + 3 = 002 (not 1002).

Serial Cmd: <K228,sequence step interval>

Default: 1

Options: Any number from 1 to 32768

Example: If **Sequence Step** is set to **3** and **Sequential Matching** is set to **Increment**:

<i>Master Symbol</i>	<i>Decoded Symbol</i>	<i>Master Symbol after Decode</i>
003	001	003
003	002	003
003	003	006
006	004	006
006	005	006
006	006	009

New Master Pin

Definition: If **Matchcode** and **New Master Pin** are enabled and the new master pin is momentarily activated (must be active for a minimum of 10 ms) master symbol information will be loaded into the database based on the next read cycle that achieves a Good Read, starting with **Index 1**.

Note: For the MicroHAWK ID-30, Input 1 (pin 12) is Default and Input 2 (pin 8) is New Master. For the MicroHAWK ID-40, Input 1 (pin 3) is Default and Input 2 (pin 4) is New Master.

Serial Cmd: <K225,status>

Default: Disabled

Options: 0 = Disabled 1 = Enabled

New Master Load Status

Definition: The new master status responds with the number of the next master position to be loaded, where 0 represents "idle" or "no master to be loaded."

Example: If the user has the **Number of Master Symbols** set to 1, and then either sends a <G> or toggles an active **New Master Pin**, the state will be 1, and prior to reading and effectively loading position 1, the response to <NEWM> would be <NEWM/1>. Once a symbol has been read and loaded, the status will be cleared: <NEWM/0>.

Serial Cmd: <NEWM>

New Master Pin

■ 10 Camera and IP Setup

Contents

Camera and IP Setup by ESP	10-2
Camera and IP Setup Serial Commands.....	10-3
Video.....	10-4
Evaluation	10-5
Calibration.....	10-8
Window of Interest.....	10-9
Configuration Database.....	10-13
Dynamic Setup	10-14
Pixel Binning	10-15
Camera Settings.....	10-16
White Balance Settings.....	10-17
Color Filter	10-18
Focus Setup.....	10-19
Illumination Brightness.....	10-21
Morphological Pre-Processing.....	10-22
Morphological Operation and Operator Size	10-23
Damaged Symbol	10-26
Linear Security Level	10-27
Set License.....	10-28

This section provides adjustment parameters for the physical controls of the camera, image acquisition, database settings, and image diagnostics.

Camera and IP Setup by ESP

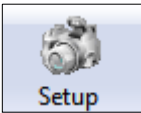

Click the **Setup** button to bring up the **Camera Setup** menu.

Parameters	ESP Values
Camera Setup	
+ Camera Settings	
Pixel Binning	Disabled
- Illumination Brightness	High*
Light Source	Off
+ Focus Distance	Low
- Window of Interest	Medium
Top	High*
Left	Constant
Height	1944
Width	2592
+ Image Processing Settings	

To change a setting, **double-click** the setting and use your cursor to scroll through the options.

To open nested options, **single-click** the +.

Camera and IP Setup Serial Commands

Window of Interest	<K516,row pointer,column pointer,row depth,column width>
Damaged Symbol	<K519,damaged symbol status>
Focus Setup	<K525,focal distance,distance units,focus mode,no-read limit>
Illumination Brightness	<K536,brightness,light source>
Camera Settings	<K541,exposure,gain>
Pixel Binning	<K542,pixel binning status>
Color Filter	<K543,color filter>
White Balance	<K544,red gain,green gain,blue gain>
Morphological Pre-Processing	<K550,status>
Morphological Operation	<K551,morphological operation,operator size>
Set License	<K556,license file name,license key>
Linear Security Level	<K560,linear security level>

Video

The **Video** view is similar to the **EZ Mode** interface, in that the user has the ability to perform the same **Locate**, **Calibrate**, and **Test** routines. There is also a focal distance adjustment tool to the right of the video view.

Video also features **Capture and Decode** functionality, which is similar to the **Configuration** interfaces (**Communication**, **Read Cycle**, **Symbologies**, **I/O**, **Matchcode**, and **Diagnostics**).

The screenshot shows the Video interface with a central video feed of a QR code. At the top are 'Locate' and 'Calibrate' buttons. Below the video feed are 'Capture and Decode', 'Test', and 'Stop' buttons. At the bottom are checkboxes for 'Decodes per Second' (checked) and 'Contrast' (unchecked), and a focal distance slider set to '4.00 inches'. A data table is at the bottom left.

Callouts:

- Locate:** Activates the reader's target pattern and initiates live video display of the symbol in the field of view.
- Calibrate:** Initiates Calibration routine.
- Capture and Decode:** Allows the user to take an image capture of the symbol in the field of view at any time, and to decode the symbol data. Similar to the **Capture and Decode** function in the **Configuration** views.
- Test:** Initiates the **Test** routine. Allows the user to test the reader's read rate and decodes per second, and also displays decoded symbol data in the field at the bottom of the screen. Click **Stop** to end the **Test** routine.
- Stop:** Clicking this icon enables the focal distance slide control to the right of the video view. The focal distance value is displayed just below the icon.
- Decodes per Second:** When enabled, shows the symbol in higher contrast than the default contrast value.
- Contrast:** Symbol data and **Test** results are shown in this field.

Attribute	Value
Number of Symbols	1
Symbol #1	
Symbol Data	Microscan

Evaluation

In **Evaluation**, you can view images currently in the reader, capture and decode a symbol, save it as a digital file, and perform histogram and line scan evaluations.

When you click on the **Evaluation** tab, you will see the images that are currently stored in the reader.

Click **Receive** to refresh this view.

Click **Capture/Decode** to display the current stored image. Only one capture and decode event will occur, regardless of read cycle settings.

Click **Read** to trigger a read cycle. If there is enough time in the read cycle, up to 32 good reads (or 6 full-scale images) can be captured and displayed, depending on the size of the images, and depending on the number enabled in **Number of Captures** under **Capture Mode** in the **Camera Setup** menu tree to the left of the tabs.

If you click **Save**, the current image will be saved to the location of your choice.

Note: An image can only be saved in the format in which it was uploaded to **ESP**. JPEG images will be saved as **.jpg**, and bitmaps will be saved as **.bmp**.

When you click the **JPEG Image** box, notice that the **Line Scan** button is grayed out.

The JPEG option allows faster captures and transfers, but since the JPEG standard compresses image data, it is not suitable for the more rigorous demands of line scan evaluation.

JPEG also allows you to adjust the image quality (resolution) by adjusting the sliding tab between 1 and 100, 1 being the lowest quality and 100 being the highest.

When possible, use the highest quality; when image transfer speed must be increased, use a lower image quality setting. Adjustments for this setting will depend on your specific hardware and software limitations.

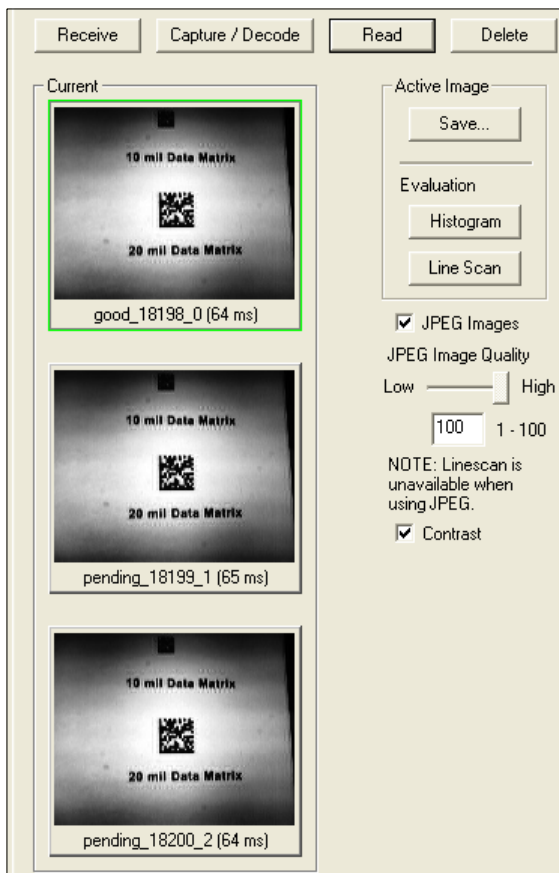

Histogram

Usage: Useful in determining quality and contrast of symbols.

Definition: A histogram is a graphic representation of the numeric count of the occurrence of each intensity (gray level) in an image. The horizontal axis represents the values of gray levels, and the vertical axis represents the number of pixels for each gray level.

Note: Since histograms are performed in the reader, the results will be saved regardless of whether the image was uploaded as a JPEG (.jpg) or a bitmap (.bmp).

1. From the **Evaluation** window, click the **Histogram** button.

The current image is transferred into the histogram operation. This may take a moment, since all the relevant pixels are being evaluated intensively.

2. When the **Histogram** window opens, you may need to expand the window and/or adjust the scroll bars in order to bring the image into view.
3. To generate a histogram, click and drag your cursor diagonally across the symbol or a portion of the symbol.

The image will be surrounded by an “area of interest box”, a dashed blue line with red anchor points that can be selected and moved by placing a cursor inside the box, and can be resized by clicking and dragging the anchor points.

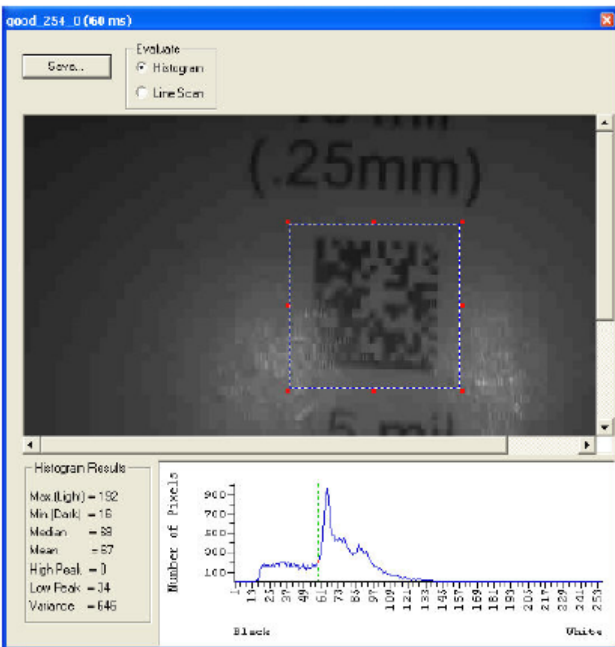

Line Scan

1. From the **Evaluation** tab, click the **Line Scan** button. A window like that shown below will appear.
 2. Drag your cursor *horizontally* across the image.
- This will create a dashed horizontal line. Pixel information and a visual representation of the dark and light pixels will be displayed below the image.

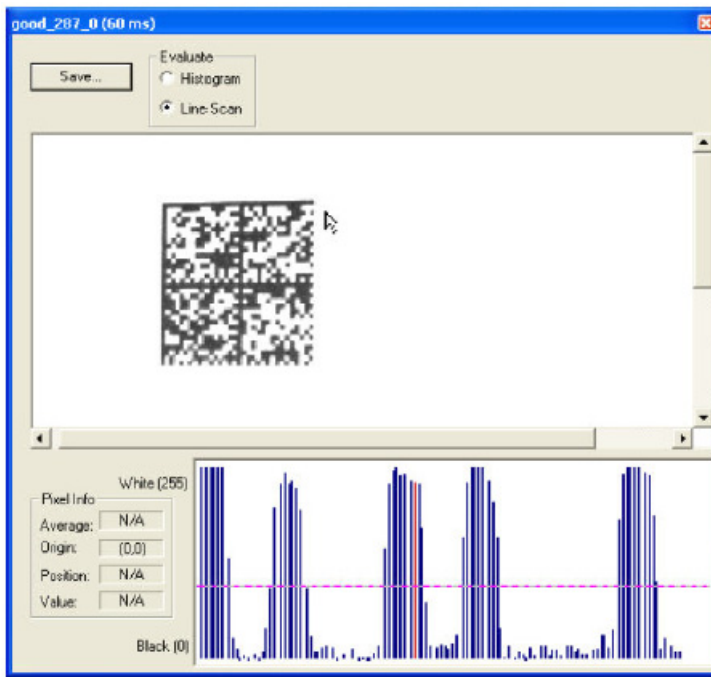

When you center your cursor over the dashed line, it becomes a double arrow cross. This allows you to move the line anywhere in the window. You can also use your keyboard arrows to move the line incrementally in any direction.

As with the histogram, the line scan compares light and dark pixels, but in a spatial distribution. On the **Y** axis of the graph below, **0** is black and **255** is white; the **X** axis represents the horizontal axis of the symbol as described by the line scan.

When you click anywhere on the graph, a vertical red line appears at that point and its position and value (in terms of black-to-white) are updated in the **Pixel Info** table to the left of the graph (237 in this example). In addition, a horizontal dashed red line is displayed that indicates the average value.

Calibration

The Calibration interface in **ESP** is a powerful and intuitive way to optimize the reader's performance. It allows the user to control several complex, simultaneous calibration operations, and to follow the progress of those operations using cues such as progress bars, real-time representations of calibration values, and other dynamic user feedback.

See the **Calibration** section for full documentation of this feature.

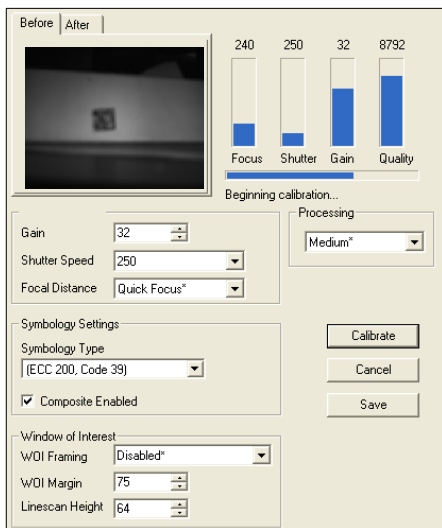

ESP's Calibration interface shown during a calibration routine

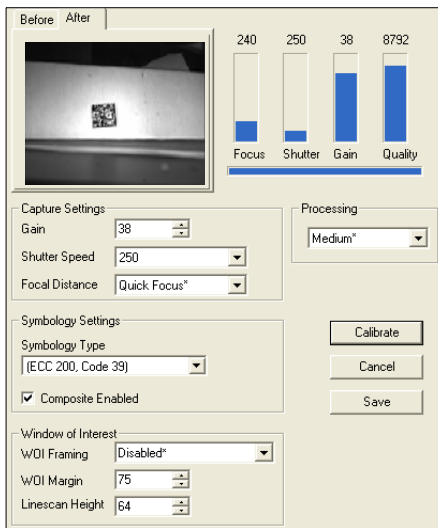

ESP's Calibration interface shown after a calibration routine

Window of Interest

The active pixel area of the image sensor is called the **Window of Interest** (WOI). The WOI allows the user to select an area of the field of view in which the desired symbol is located.

The programmable window of interest increases decode speed, improves threshold, and makes it easy to select specific symbols from among several in the field of view. The user provides the upper-left pixel location and the size of the window in rows and columns to define the Window of Interest.

Important: Window of Interest will shrink the field of view and therefore could cause some symbols to be missed in dynamic applications.

Window of Interest by ESP

1. From the **Camera** menu, click the **WOI** tab to bring up **Window of Interest**.
If you haven't already captured an image, click the **Capture and Decode** button to decode the present image. If successful, the **Good Read** indicator on the **WOI** tab will be green and the symbol will appear in the pane below.
Note: You can resize the image by clicking and dragging the **ESP** window from the lower right corner. This is useful where very small symbols are being read.
2. Click and drag your cursor over the symbol that you want to isolate for reading.
Notice that the surrounding area goes black.
You can use the handles on the image area that you have just drawn to resize the region of interest. You can also click on the center of the window of interest and move it.
3. Test the new settings in **Read Rate Mode**.

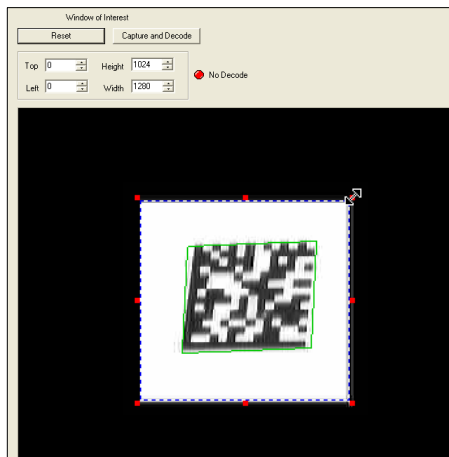
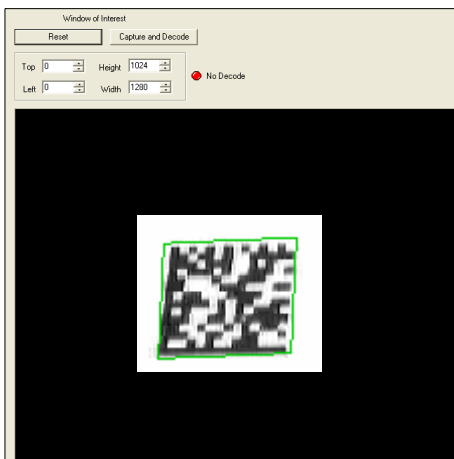

Note: To remove the window of interest, click the **Reset** button or click anywhere in the WOI pane.

Note that all pixels not in the WOI are defined as black.

Because the reader has far less processing to do in a smaller window, read rates typically increase dramatically. One possible downside is that the chance of missing a symbol increases with the smaller window. Always verify that your WOI will be large enough to allow for any random movement of symbols in your field of view.

Window of Interest by Serial Command

The figure shows where to locate the start position of the row and column pointers and how to measure the column depth and row width dimensions.

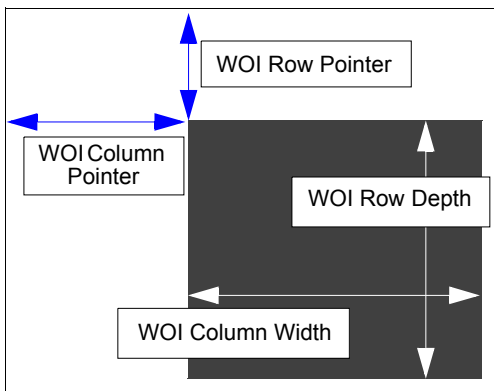

Row Pointer

Definition: Defines the row position of the upper-left starting point of the image window.

Serial Cmd: <K516,row pointer,column pointer,row depth,column width>

Default: QSXGA MicroHAWK ID: 0

SXGA MicroHAWK ID: 0

WVGA MicroHAWK ID: 0

Options: QSXGA MicroHAWK ID: 0 to (1944 – row depth)

SXGA MicroHAWK ID: 0 to (1024 – row depth)

WVGA MicroHAWK ID: 0 to (480 – row depth)

Column Pointer

Definition: Defines the column position of the upper-left starting point of the image window.

Serial Cmd: <K516,row pointer,column pointer,row depth,column width>

Default: QSXGA MicroHAWK ID: 0

SXGA MicroHAWK ID: 0

WVGA MicroHAWK ID: 0

Options: QSXGA MicroHAWK ID: 0 to (2592 – column width)

SXGA MicroHAWK ID: 0 to (1280 – column width)

WVGA MicroHAWK ID: 0 to (752 – column width)

Row Depth

Definition: Defines the size, in rows, of the image window. Maximum value is defined as the maximum row size of the image sensor minus the Row Pointer value.

Serial Cmd: <**K516**,row pointer,column pointer,**row depth**,column width>

Default: **QSXGA MicroHAWK ID: 1944**

SXGA MicroHAWK ID: 1024

WVGA MicroHAWK ID: 480

Options: **QSXGA MicroHAWK ID: 3 to (1944 – row pointer)**

SXGA MicroHAWK ID: 3 to (1024 – row pointer)

WVGA MicroHAWK ID: 3 to (480 – row pointer)

Column Width

Definition: Defines the size, in columns, of the image window. Maximum value is defined as the maximum column size of the image sensor minus the Column Pointer value.

Serial Cmd: <**K516**,row pointer,column pointer,row depth,**column width**>

Default: **QSXGA MicroHAWK ID: 2592**

SXGA MicroHAWK ID: 1280

WVGA MicroHAWK ID: 752

Options: **QSXGA MicroHAWK ID: 8 to (2592 – column pointer)**

SXGA MicroHAWK ID: 8 to (1280 – column pointer)

WVGA MicroHAWK ID: 8 to (752 – column pointer)

Important Notes

- The column width value must be a modulus 8 value. Regardless of the column width setting that is configured, the actual column width will be decreased if necessary to a modulus 8 value. For example, a column width value of **639** would actually be **632**. A user query for the value of this setting would still return **639**.
- The column pointer must be an even value. Regardless of the column pointer setting that is configured, the actual column pointer will be decreased if necessary to an even value. For example, a column pointer value of **101** would actually be **100**. A user query for the value of this setting would still return **101**.

Configuration Database

The Configuration Database allows the user to manage multiple configuration profiles. It is a useful tool in applications that require several different reader configurations to be applied sequentially, and it allows the user to perform far more complex operations than would be possible with only one set of configuration parameters.

See **Configuration Database** for full documentation of this feature.

Active Indexes 5 Auto Sync Database settings with Reader Advanced Options...

Capture Settings

Processing Settings

Current: 10000 25 Disable 0 0 1944 2592 ... Erode Small ECC 200

<input checked="" type="radio"/>	10000	20	Disable	0	0	1944	2592	...	Disable	Small	Disabled	Test
<input type="radio"/>	10000	20	Disable	0	0	1944	2592	...	Disable	Small	Disabled	Test
<input type="radio"/>	10000	20	Disable	0	0	1944	2592	...	Disable	Small	Disabled	Test
<input type="radio"/>	10000	20	Disable	0	0	1944	2592	...	Disable	Small	Disabled	Test
<input type="radio"/>	10000	20	Disable	0	0	1944	2592	...	Disable	Small	Disabled	Test
<input type="radio"/>	10000	20	Disable	0	0	1944	2592	...	Disable	Small	Disabled	Test
<input type="radio"/>	10000	20	Disable	0	0	1944	2592	...	Disable	Small	Disabled	Test
<input type="radio"/>	10000	20	Disable	0	0	1944	2592	...	Disable	Small	Disabled	Test
<input type="radio"/>	10000	20	Disable	0	0	1944	2592	...	Disable	Small	Disabled	Test
<input type="radio"/>	10000	20	Disable	0	0	1944	2592	...	Disable	Small	Disabled	Test

Capture for Every Index
 Show Database Index in Output
 Sort Index Positions on Good Reads

Configuration Database view, 5 Active Indexes, Capture Settings highlighted

Dynamic Setup

Dynamic Setup is used to calculate image capture timing during a read cycle. Without proper timing, the reader will not be able to decode all symbols in a read cycle. An external trigger is used to activate image captures so the user can make timing adjustments as capture events occur.

The user can control Capture #, Number of Captures, and Number of Symbols using these spin boxes.

Read Rate is represented graphically in real-time as the user makes adjustments to the time delay between image captures.

Capture #: 1
Number of Captures: 1
Number of Symbols: 1

Delay (Sec): 0.078432

Delay Adjustment:
 Coarse
 Medium
 Fine

Decrease Increase

The Delay Adjustment slider allows the user extremely precise control of the time delays between image captures in a read cycle. Delay values are shown in seconds in the field above the slider. The Coarse and Fine Delay Adjustment options determine whether larger or smaller adjustment increments will be used.

Pixel Binning

Definition: In addition to windowing the image sensor, smaller resolutions can be obtained by down sampling the entire captured image by using pixel binning. Pixel binning can increase the signal to noise ratio and produce a more pleasing output image with reduced artifacts. It will also improve low-light performance. It is important to note that enabling pixel binning does not affect the sensor frame rate as the pixels still need to be processed in order to be averaged and binned.

Usage: <K542, pixel binning>

Default: Disabled

Options: 0 = Disabled 1 = Enabled

Disabled

Pixel-binning is disabled.

Enabled

Two column pixels and two row pixels are averaged to create a single pixel value providing a 2:1 reduction in the vertical pixels and a 2:1 reduction in the horizontal pixels for a combined 4:1 reduction. An image with a dimension of 640 x 480 will be scaled to 320 x 240.

Camera Settings

Camera Settings are typically obtained during the calibration process, and do not necessarily need to be modified directly by the user.

QSXGA, SXGA, and WVGA

Exposure

Usage: Faster exposures reduce blurring in faster applications. Slower exposures are useful in slower applications and lower contrast applications.

Definition: This value sets the exposure or integration time (in micro-seconds) for the image sensor pixels. The exposure setting in relation to the speed of the object is critical. If an object is moving rapidly and too long an exposure value is selected, blurring or smearing of the object will occur. As exposure time is decreased the movement of the object becomes less of a factor but, with the duration of light collection by the pixels reduced, the image sensor gain will need to be increased to compensate.

Serial Cmd: <K541,exposure,gain>

Default: **All versions: 2,500 μ s**

Options: Any number between 50 – 100,000

Note: The Exposure parameter is read-only when the reader is in **Continuous Read Auto Trigger Mode**.

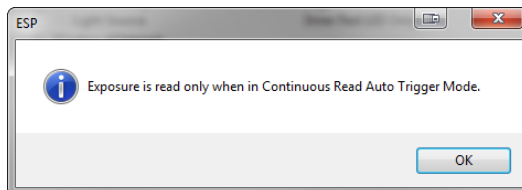

Gain

Usage: Can be used to adjust the brightness of the image.

Definition: Sets the gain value for the image sensor and is a percentage value from 0 (lowest gain) to 100% (highest gain). This setting can be configured through auto-calibration. A higher gain value will increase the brightness of the image, but the noise performance of the system will be reduced. Before configuring the gain, the required exposure should be set, and the gain should be configured to optimize the exposure setting.

Serial Cmd: <K541,exposure,gain>

Default: **QSXGA: 33%**

SXGA: 0%

WVGA: 33%

Options: Any number between 0 – 100

White Balance Settings (Q SXGA Color Only)

Definition: <K544,red gain,green gain,blue gain>

Default: **Factory-Calibrated**

Options: Any number between 0 – 100

Red Gain

Sets the gain value for the red color channel of the image sensor and is a percentage value from 0% (lowest gain) to 100% (highest gain). The color channel parameters are used to avoid unrealistic colors so that objects that appear white to the human eye are rendered white in the final image. The default value for this parameter is factory-calibrated.

Green Gain

Sets the gain value for the green color channel of the image sensor and is a percentage value from 0% (lowest gain) to 100% (highest gain). The color channel parameters are used to avoid unrealistic colors so that objects that appear white to the human eye are rendered white in the final image. The default value for this parameter is factory-calibrated.

Blue Gain

Sets the gain value for the blue color channel of the image sensor and is a percentage value from 0% (lowest gain) to 100% (highest gain). The color channel parameters are used to avoid unrealistic colors so that objects that appear white to the human eye are rendered white in the final image. The default value for this parameter is factory-calibrated.

Color Filter

Definition: If you are using a 5 megapixel color MicroHAWK, this filter captures an image in color. To process the image for symbol decoding, the image must be filtered or the R, G, and B cells need to be equalized. This can be done by applying one of the filters available or by performing a white balance with the current camera configuration before trying to decode a symbol. This option specifies the filter method that is applied to the RGB color image to produce a monochrome image.

Usage: <K543,color filter>

Default: Disabled

Options: 0 = Disabled (Raw, No Filter)

1 = Enabled

2 = Horizontal 1D Symbols

3 = Green Interpolate

Disable

No filter is applied to image. If you are attempting to read symbols with no filter applied, a white balance should be performed first to balance the red, blue, and green cells of the image sensor.

General Purpose

This is a general purpose filter that is applied to the RGB image to provide a grayscale image that can be used for most applications.

This filter should be used when reading 2D symbols, 1D symbols that are not positioned horizontally in the field of view, or a combination of 1D and 2D symbols.

Horizontal 1D Symbols

This filter is applied to the RGB image to provide a grayscale image that is specifically designed to provide the best suitable image for a horizontally-positioned 1D symbol.

This filter should be used when reading 1D symbols that are positioned horizontally across the field of view.

Green Interpolate

This filter is applied to the RGB image to provide a grayscale image for decoding similar to a luminance calculation. Unlike a luminance calculation, Green Interpolate provides an image 1:1 resolution to the input image. This filter provides better omni-directional symbol decode performance. Like Horizontal 1D Symbols, and unlike General Purpose, a white balance is not necessary.

This filter is recommended for most decoding applications that can afford extra processing time.

Note: For high-resolution 1D symbols that are positioned horizontally, the Horizontal 1D Symbols filter is preferable.

Focus Setup

Focal Distance

Definition: Provides the focal distance adjustment for the camera.
 When **Distance Units** is set to **Millimeters**, the **Focal Distance** parameter has a range of **25 to 4,000**. Any value outside this range will be rejected.
 When **Distance Units** is set to **1/100 in.**, **Focal Distance** is limited to a range of **200 to 2,000**. If you attempt to set the **Focal distance** to less than 200 (2 in.), the parameter will be left as-is.

Serial Cmd: <K525,focal distance,distance units,focus mode,no-read limit>

Default: 80

Options: 25 to 4,000 (mm)
 100 to 4,000 (1/100 inch)

Distance Units

Definition: Defines the measurement unit value of the **Focal Distance** parameter.

Serial Cmd: <K525,focal distance,distance units,focus mode,no-read limit>

Default: Millimeters

Options: 0 = Millimeters
 1 = 1/100 inch

For example, the following are valid configurations to set the **Focal Distance** to three distances:

Required Focal Distance	Distance Units = mm (0)	Distance Units = 1/100 in. (1)
2 inch, or 50 mm	<K525,50,0>	<K525,200,1>
3 inch, or 76 mm	<K525,76,0>	<K525,300,1>
6 inch, or 152 mm	<K525,152,0>	<K525,600,1>

Focus Mode

Definition: This field set to **1** enables the autofocus mode to be enabled. The read cycle must also be a **Continuous Read** mode or **Continuous Read Auto** (Auto Photometry) mode. Autofocus mode does not apply to triggered read cycles. If the value is set to **0**, only the distance value is used.

Serial Cmd: <K525,focal distance,distance units,focus mode,no-read limit>

Default: No-Read Autofocus

Options: 0 = User Value Only
 1 = No-Read Autofocus

No-Read Limit

Definition: This is the number of no-reads that are encountered consecutively in a **Continuous Read** mode to trigger an **Autofocus** pass.

Serial Cmd: <**K525**,focal distance,distance units,focus mode,**no-read limit**>

Default: **5**

Options: 1 to 255

Illumination Brightness

Definition: This feature allows you to adjust the brightness of the illumination LEDs. Since the reader has control over the brightness of the illumination, it can provide consistent brightness output between readers through a factory calibration operation. Each of the brightness settings is calibrated to provide the same level of intensity for each reader.

Serial Cmd: <**K536,brightness,light source**>

Default: **High**

Options:

- 0 = Off
- 1 = Low
- 2 = Medium
- 3 = High**
- 4 = Constant

Constant

When set to **Constant**, the illumination brightness is the same power level as the High setting. However, the LEDs will always be on during a read cycle and will only be off between read cycles. This cuts down on perceptible LED flashing.

Light Source

Definition: The setting allows the user to change the illumination light source.

Serial Cmd: <**K536,brightness,light source**>

Options:

- 1 = Embedded White Only (Default for ID-20 QSXGA)
- 2 = Embedded Red Only (Default for ID-20 WVGA and SXGA)
- 3 = External Only (Default for ID-30 and ID-40)

Morphological Operation and Operator Size

Morphological Operation

Definition: **Morphological Operation** allows the user to select the method for processing captured images.

Serial Cmd: <K551,0,morphological operation,operator size>

Default: **Erode**

Options: **0 = Erode**

1 = Dilate

2 = Open

3 = Close

Erode

Erode increases the dark cell size of a symbol. Useful for increasing the dark cell size of a dark-on-light Data Matrix symbol.

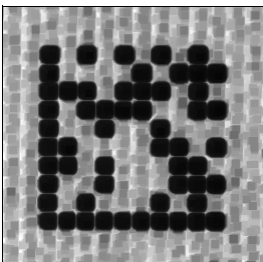

Dilate

Dilate increases the light cell size of a symbol. Useful for increasing the light cell size of a light-on-dark Data Matrix symbol.



Open

Open removes minor light defects of dark cells by performing a **Dilate** function followed by an **Erode** function.

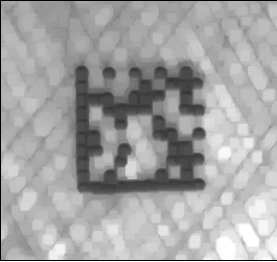

Close

Close removed minor dark defects of light cells by performing an **Erode** function followed by a **Dilate** function.

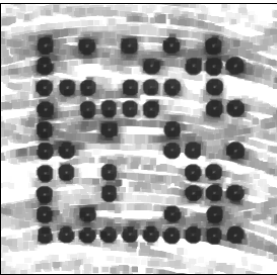

Operator Size

Definition: **Operator Size** determines the size of the area or “pixel neighborhood” (measured in pixels) in which the morphological operation is being performed.

Serial Cmd: <**K551,0,morphological operation,operator size**>

Default: **Small**

Options: **3 = Small (3 pixels by 3 pixels)**
5 = Medium (5 pixels by 5 pixels)
7 = Large (7 pixels by 7 pixels)

Damaged Symbol

Definition: When **Damaged Symbol** is enabled, the reader will make additional attempts to decode damaged Code 128 and Code 39 symbols. It is effective on symbols with high noise and partial bar missing. Enabling Damaged Symbol may significantly increase decode time.

Serial Cmd: <**K519**,*damaged symbol status*>

Default: **Disabled**

Options: **0 = Disabled**
1 = Enabled

Linear Security Level

Definition: **Linear Security Level** is intended to prevent misreads. When it is set to a higher level, it requires more scan lines to decode the same result, making it more secure.

Serial Cmd: <**K560**,linear security level>

Default: **Aggressive**

Options: **0 = Aggressive**

1 = Normal

2 = Secure

Set License

Serial Cmd: <**K556**,license file name,license key>

License File Name

The **License File Name** is the name of the file that holds the license key. The file name should be no longer than 32 characters including the mandatory **.lic** extension. By convention, the file name should begin with the first three octets of the target device's MAC address followed by a short key descriptor. An example filename is **17B2C3-X-Mode.lic**.

License Key

The **License Key** field is a 29 character string representing the license key. The key is generated by a proprietary licensing tool and the format is a sequence of five five-character dash-separated fields. An example key is **12345-67890-ABCDE-FGHIJ-KLMNO**.



11 Configuration Database

Contents

- Configuration Database Serial Commands 11-2
- Number of Active Indexes 11-3
- Configuration Database Status..... 11-4
- Database Mode 11-10
- Save Current Settings to Configuration Database..... 11-15
- Load Current Settings from Configuration Database..... 11-16
- Request Selected Index Settings 11-17
- Request All Configuration Database Settings 11-17

This section concerns the various capture settings and processing settings that can be used to fine-tune the MicroHAWK ID's performance in your application.

Configuration Database Serial Commands

Number of Active Indexes	<K252,number of active indexes,sort database>
Configuration Database Status	<K255,index,exposure,gain,focal distance,pixel binning,row pointer,column pointer,row depth,column width,symbology,morphology operator, morphology size>
Save Current Settings to Database	<K255+,index>
Load Current Settings from Database	<K255-,index>
Request Selected Index Settings	<K255?,index>
Request All Database Settings	<K255?>
Database Mode	<K256,switch mode,frame count/time,image process looping,image dimensions>

Number of Active Indexes

Usage: Useful for applications that require several different complex reader configurations to be applied sequentially. Multiple database indexes allow you to concatenate configuration profiles, and to perform more complex operations than would be possible with only one set of configuration parameters.

Definition: This feature allows you to set the number of database records (groups of settings) that will be used automatically during the read cycle. If **Number of Active Indexes** is set to 0, only the current reader settings will be used, not database entry settings.

Serial Cmd: <K252,number of active indexes,sort database>

Default: 0 (Disabled)

Options: 0 to 10

Sort Database

Definition: **Sort Database** moves the database entry that produced a successful decode to the first position in the list of database entries.

Serial Cmd: <K252,number of active indexes,sort database>

Default: Disabled

Options: 0 = Disabled 1 = Enabled

Number of Active Indexes by ESP

Click the arrow on the **Active Indexes** dropdown menu and select how many database indexes will be used during the read cycle. (0 to 10).

The screenshot shows the configuration interface with the following details:

- Active Indexes:** 5 (dropdown menu)
- Auto Sync Database settings with Reader:**
- Advanced Options...** button
- Capture Settings:** Includes sliders for Capture Index, Exposure, Gain, Pixel Binning, Top, Left, Height, Width, and ROI.
- Processing Settings:** Includes sliders for Morphology, Morphology Size, and Symbol Type.
- Current:** 10000, 25, Disable, 0, 0, 1944, 2592
- Erode:** Small, ECC 200
- Table of 10 Database Entries:**

Index	Exposure	Gain	Pixel Binning	Top	Left	Height	Width	Morphology	Morphology Size	Symbol Type
1	10000	20	Disable	0	0	1944	2592	Disable	Small	Disabled (Test)
2	10000	20	Disable	0	0	1944	2592	Disable	Small	Disabled (Test)
3	10000	20	Disable	0	0	1944	2592	Disable	Small	Disabled (Test)
4	10000	20	Disable	0	0	1944	2592	Disable	Small	Disabled (Test)
5	10000	20	Disable	0	0	1944	2592	Disable	Small	Disabled (Test)
6	10000	20	Disable	0	0	1944	2592	Disable	Small	Disabled (Test)
7	10000	20	Disable	0	0	1944	2592	Disable	Small	Disabled (Test)
8	10000	20	Disable	0	0	1944	2592	Disable	Small	Disabled (Test)
9	10000	20	Disable	0	0	1944	2592	Disable	Small	Disabled (Test)
10	10000	20	Disable	0	0	1944	2592	Disable	Small	Disabled (Test)
- Sort Index Positions on Good Reads:**
- Buttons:** Calibrate..., Receive Settings, Send Settings, Load Current To Index, Load Index To Current

Sort Index Positions on Good Reads moves the database entry that produces the first successful decode to the top of the list.

Configuration Database Status

Index

Usage: Useful for applications that require several different complex reader configurations to be applied sequentially. Multiple database indexes allow you to concatenate configuration profiles, and to perform more complex operations than would be possible with only one set of configuration parameters.

Definition: Determines the specific database index that will be used.

Serial Cmd: <**K255,index,exposure,gain,focal distance,pixel binning,row pointer,column pointer,row depth,column width,symbology,morphology operator,morphology size**>

Options: 1 to 10

Exposure

Serial Cmd: <**K255,index,exposure,gain,focal distance,pixel binning,row pointer,column pointer,row depth,column width,symbology,morphology operator,morphology size**>

Default: **10,000**

Options: 50 to 100,000

Note: The Exposure parameter is read-only when the reader is in **Continuous Read** mode.

Gain

Serial Cmd: <**K255,index,exposure,gain,focal distance,pixel binning,row pointer,column pointer,row depth,column width,symbology,morphology operator,morphology size**>

Default: **25**

Options: 0 to 100

Focal Distance

Definition: Provides the focal distance adjustment for the camera.

When **Distance Units** is set to **Millimeters**, the **Focal Distance** parameter has a range of **25** to **4,000**. Any value outside this range will be rejected.

When Distance Units is set to **1/100 in.**, Focal Distance is limited to a range of **200** to **2,000**. If you attempt to set the Focal distance to less than 200 (2 in.), the parameter will be left as-is.

Serial Cmd: <**K255,index,exposure,gain,focal distance,pixel binning,row pointer,column pointer,row depth,column width,symbology,morphology operator,morphology size**>

Default: **80**

Options: 25 to 4,000 (mm)

100 to 4,000 (1/100 inch)

Pixel Binning

Serial Cmd: <K255,index,exposure,gain,focal distance,pixel binning,row pointer,column pointer,row depth,column width,symbology,morphology operator,morphology size>

Default: **Disabled**

Options: **0 = Disabled** 1 = Enabled

Important: Pixel Binning has no effect when the **Image Dimension** mode is configured as **Region of Interest** in the **Database Mode** command. This is because the **Window of Interest** camera settings are determined by the software based on the **Region of Interest** setup. There is no benefit to Pixel Binning to increase processing speed when ROI is configured, because the frame size would need to be increased to make Pixel Binning possible.

Row Pointer

Definition: The image dimension settings can be applied as a Window of Interest or a Region of Interest, depending on the image dimension mode selected in the **Database Mode** command.

Serial Cmd: <K255,index,exposure,gain,focal distance,pixel binning,row pointer,column pointer,row depth,column width,symbology,morphology operator,morphology size>

Default: **All models: 0**

Options: **QSXGA MicroHAWK ID:** 0 to (1944 – row depth)
SXGA MicroHAWK ID: 0 to (1024 – row depth)
WVGA MicroHAWK ID: 0 to (480 – row depth)

Column Pointer

Definition: The image dimension settings can be applied as a Window of Interest or a Region of Interest, depending on the image dimension mode selected in the **Database Mode** command.

Serial Cmd: <K255,index,exposure,gain,focal distance,pixel binning,row pointer,column pointer,row depth,column width,symbology,morphology operator,morphology size>

Default: **All models: 0**

Options: **QSXGA MicroHAWK ID:** 0 to (2592 – column width)
SXGA MicroHAWK ID: 0 to (1280 – column width)
WVGA MicroHAWK ID: 0 to (752 – column width)

Row Depth

Definition: The image dimension settings can be applied as a Window of Interest or a Region of Interest, depending on the image dimension mode selected in the **Database Mode** command.

Serial Cmd: <**K255**,*index,exposure,gain,focal distance,pixel binning,row pointer,column pointer,row depth,column width,symbology,morphology operator,morphology size*>

Default: **QXGA MicroHAWK ID: 1944**
SXGA MicroHAWK ID: 1024
WVGA MicroHAWK ID: 480

Options: **QXGA MicroHAWK ID: 3 to (1944 – row pointer)**
SXGA MicroHAWK ID: 3 to (1024 – row pointer)
WVGA MicroHAWK ID: 3 to (480 – row pointer)

Column Width

Definition: The image dimension settings can be applied as a Window of Interest or a Region of Interest, depending on the image dimension mode selected in the **Database Mode** command.

Serial Cmd: <**K255**,*index,exposure,gain,focal distance,pixel binning,row pointer,column pointer,row depth,column width,symbology,morphology operator,morphology size*>

Default **QXGA MicroHAWK ID: 2592**
SXGA MicroHAWK ID: 1280
WVGA MicroHAWK ID: 752

Options: **QXGA MicroHAWK ID: 8 to (2592 – column pointer)**
SXGA MicroHAWK ID: 8 to (1280 – column pointer)
WVGA MicroHAWK ID: 8 to (752 – column pointer)

Symbology

Definition: This field allows the user to configure the database to enable specific symbologies for selected database indexes. Symbology-specific parameters must be configured with the appropriate symbology command.

For example, if fixed length Code 128 is required, it must first be set up with the Code 128 command: **<K474>**.

To select a particular symbology, add the number value associated with that symbology.

Examples:

If Data Matrix and Code 39 are required, the parameter would be: $2 + 16 = \mathbf{18}$.

If I 2/5, BC412, and DataBar Limited are required, the parameter would be: $128 + 2048 + 16384 = \mathbf{18560}$.

Serial Cmd: **<K255,index,exposure,gain,focal distance,pixel binning,row pointer,column pointer,row depth,column width,symbology,morphology operator,morphology size>**

Default: **Disabled**

Disabled

When **Symbology** is disabled, the database uses the current **Symbology** setup to determine active symbologies.

Any Symbology (Add 1)

All symbologies *except Pharmacode* are enabled while this database index is being used.

Data Matrix (Add 2)

If enabled, Data Matrix will be active for this database index.

Important: The ECC level must be configured using the Data Matrix command **<K479>**. If no ECC level has been configured, the reader will not decode Data Matrix symbols.

QR Code (Add 4)

If enabled, QR Code will be active for this database index.

Code 128 (Add 8)

If enabled, Code 128 will be active for this database index.

Code 39 (Add 16)

If enabled, Code 39 will be active for this database index.

Codabar (Add 32)

If enabled, Codabar will be active for this database index.

Code 93 (Add 64)

If enabled, Code 93 will be active for this database index.

Interleaved 2 of 5 (Add 128)

If enabled, Interleaved 2 of 5 will be active for this database index.

UPC/EAN (Add 256)

If enabled, UPC/EAN will be active for this database index.

PDF417 (Add 512)

If enabled, PDF417 will be active for this database index.

MicroPDF417 (Add 1024)

If enabled, MicroPDF417 will be active for this database index.

BC412 (Add 2048)

If enabled, BC412 will be active for this database index.

Pharmacode (Add 4096)

If enabled, Pharmacode will be active for this database index.

DataBar-14 (Add 8192)

If enabled, DataBar-14 will be active for this database index.

Important: If the stacked and non-stacked operation is required, the DataBar-14 command must be configured as follows: **<K482,2>**. If the DataBar-14 status parameter in the **<K482>** command is set to either Disabled or Enabled, the reader will only read non-stacked DataBar-14 symbols.

DataBar Limited (Add 16384)

If enabled, DataBar Limited will be active for this database index.

DataBar Expanded (Add 32768)

If enabled, DataBar Expanded will be active for this database index.

Important: If the stacked and non-stacked operation is required, the DataBar Expanded command must be configured as follows: **<K484,2>**. If the DataBar Expanded status parameter in the **<K484>** command is set to either Disabled or Enabled, the reader will only read non-stacked DataBar Expanded symbols.

Micro QR Code (Add 65536)

If enabled, Micro QR Code will be active for this database index.

Aztec (Add 131072)

If enabled, Aztec will be active for this database index.

Postal Symbolologies (Add 262144)

If enabled, Postal Symbolologies will be active for this database index.

Morphology Operator

Definition: Specifies the morphology operation (**erode**, **dilate**, **open**, **close**) used to pre-process the WOI.

Serial Cmd: <**K255**,*index,exposure,gain,focal distance,pixel binning,row pointer,column pointer,row depth,column width,symbology,morphology operator,morphology size*>

Default: **Erode**

Morphology Size

Definition: Specifies the morphology operator size to apply: **Small (3 x 3)**, **Medium (5 x 5)**, and **Large (7 x 7)**.

Serial Cmd: <**K255**,*index,exposure,gain,focal distance,pixel binning,row pointer,column pointer,row depth,column width,symbology,morphology operator,morphology size*>

Default: **Disabled**

Database Mode

Switch Mode

Definition: Selects the event that causes the reader to load the next database entry to current, active settings. When **Frame Count/Time** expires and **Image Process Looping** is enabled, the next database entry with modifications to camera settings will be used.

Note: The image capture event always occurs when the first database entry is used.

Note: The **Switch Mode** setting has no effect on **Rapid Capture Mode**, which always operates in **Number of Image Frames** mode with a frame count of 1.

Serial Cmd: <K256,switch mode,frame count/time,image process looping,image dimensions>

Default: 1

Options: 0 = Time 1 = Number of Image Frames

Time

When **Switch Mode** is set to **Time**, the reader will load the next database entry to current, active settings after a predefined time interval. The timer will start upon use of a database entry. If the timer expires during an image capture event, the timer will not start again until that database entry has been incremented and the new database entry has been loaded to current, active settings.

Number of Image Frames

When **Switch Mode** is set to **Number of Image Frames**, the database entry is incremented after the predetermined number of image capture events has occurred.

Frame Count/Time

Definition: Indicates the **Number of Image Frames** that must be captured or the amount of **Time** that must transpire before the reader will load the next database index entry.

Serial Cmd: <K256,switch mode,frame count/time,image process looping,image dimensions>

Default: 1 (frames/ms)

Options: 1 to 65535

Image Process Looping

- Usage:** Useful in applications where it is necessary to process a single captured image multiple times using different IP and decode parameters.
- Serial Cmd:** <K256,switch mode,frame count/time,**image process looping**,image dimensions>
- Default:** **Disabled**
- Options:** **0 = Disabled** 1 = Enabled

Disabled

When **Image Process Looping** is set to **Disabled**, an image is captured for every database configuration, whether or not any camera settings have been modified.

Enabled

When **Image Process Looping** is set to **Enabled**, the last captured image frame is re-processed with the new IP and decode parameters. If camera settings have not been changed from the last capture event, and when a database configuration is loaded to current, active settings, no new image is captured.

Note: An exception to this is the first database index: a new image is always captured when the first database index is used. When a camera setting has been modified from one database setting to the next, a new image is captured. For example, if all database entries contained the same camera setting values but had different IP and decode parameters, an image frame would only be captured when the first database configuration was used.

Image Dimensions

Definition: Determines how the image dimension parameters will be implemented.

Serial Cmd: <K256,switch mode,frame count/time,image process looping,**image dimensions**>

Default: 0

Options: 0 = Window of Interest 1 = Region of Interest

Window of Interest (WOI) by ESP

When **Image Dimensions** is set to **Window of Interest**, the database image dimension parameters are *camera settings*, and they determine the size of the image to be captured.

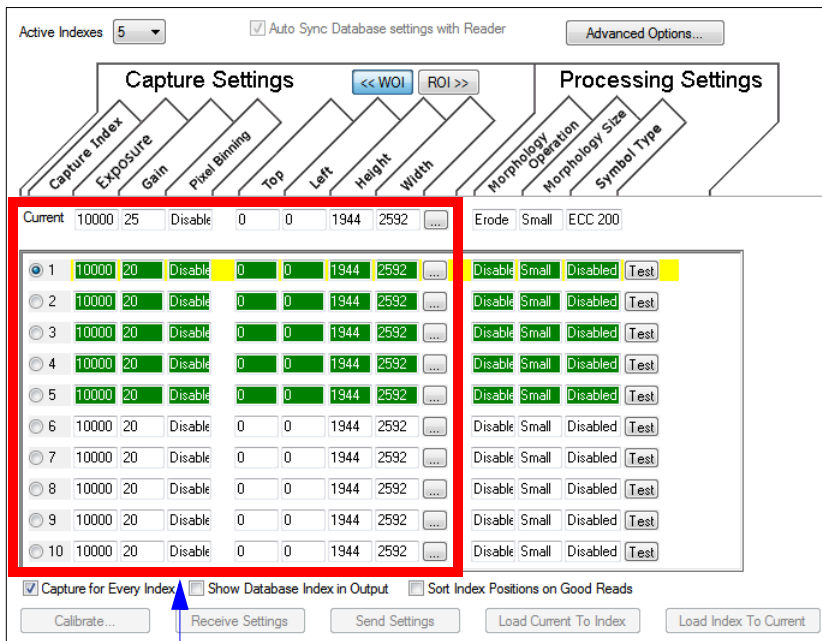

Camera settings (**Capture Index, Exposure, Gain, Pixel Binning**) located in the left half of the highlighted area.

Image capture dimensions located in the right half of the highlighted area.

Region of Interest (ROI)

When **Image Dimensions** is set to Region of Interest, the database image dimension parameters are *IP and decode settings*, and they determine the region or area of the captured image to be processed.

ROI coordinate data is based on the full image size. The **WOI** of the captured image will be configured to cover all the ROI settings in the current, active database entry. In the following example, there are three active database settings, each with a different ROI configuration. Their coordinates are based at point 0,0 of the full scale image. In this example, **DB1** and **DB3** determine the size of the captured image WOI, while DB2 has no impact. The image WOI is not configurable. It is automatically set up by the database according to the ROI settings.

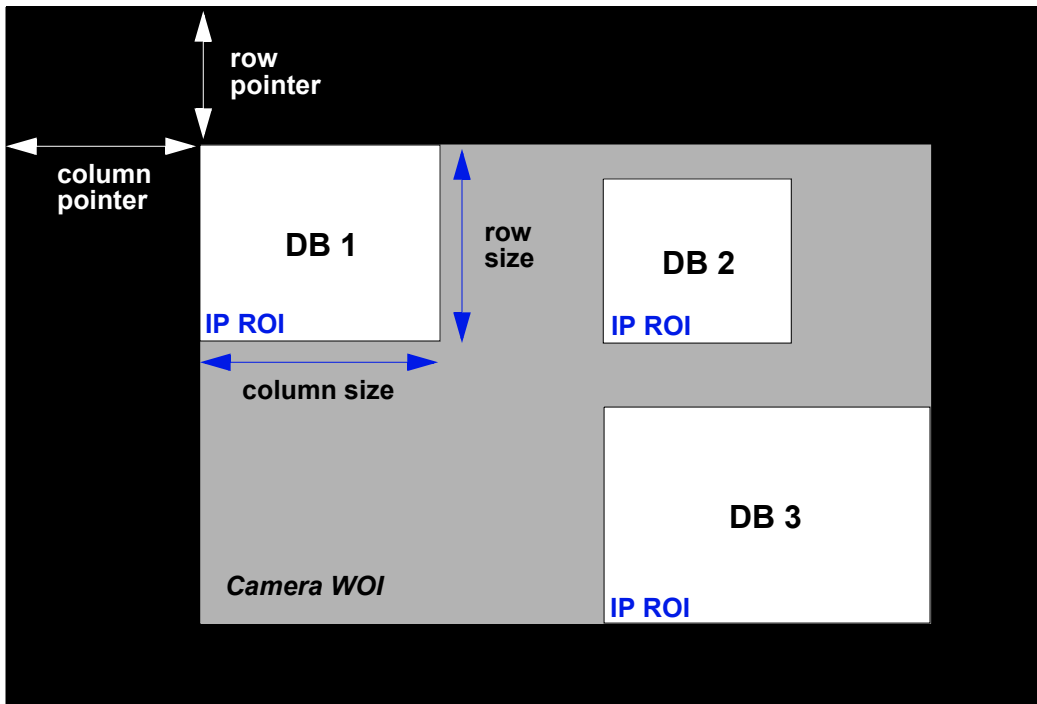

Full Image Size (SXGA Reader: 1280 x 1024; WVGA Reader: 752 x 480)

Note: Since the **ROI** parameters are not a camera setting, a change in **ROI** parameters from one index to another does *not* indicate an image capture event.

This feature is intended to be used in conjunction with **Image Process Looping**, to allow different regions of a captured image to be processed using different IP and decode settings.

Also, if this feature is used in conjunction with **Output Filtering**, multiple decoded symbols in a captured image frame can be output according to their location in the field of view.

Region of Interest (ROI) by ESP

When **Image Dimensions** is set to Region of Interest, the database image dimension parameters are *IP and decode settings*, and they determine the region or area of the captured image to be processed.

The screenshot shows a software interface with two main sections: **Capture Settings** and **Processing Settings**. The **Capture Settings** section includes parameters like Capture Index, Exposure, Gain, Pixel Binning, Top, Left, Height, and Width. The **Processing Settings** section includes Morphology Operation, Morphology Size, and Symbol Type. A table below these sections lists 10 indices. The first index (1) is selected, and its processing settings are highlighted with a red box. An arrow points to the 'Load Index To Current' button at the bottom.

Index	Capture Index	Exposure	Gain	Pixel Binning	Top	Left	Height	Width	Morphology Operation	Morphology Size	Symbol Type
1	10000	20	Disable		0	0	1944	2592	Erode	Small	ECC 200
2	10000	20	Disable		0	0	1944	2592	Disable	Small	Disabled
3	10000	20	Disable		0	0	1944	2592	Disable	Small	Disabled
4	10000	20	Disable		0	0	1944	2592	Disable	Small	Disabled
5	10000	20	Disable		0	0	1944	2592	Disable	Small	Disabled
6	10000	20	Disable		0	0	1944	2592	Disable	Small	Disabled
7	10000	20	Disable		0	0	1944	2592	Disable	Small	Disabled
8	10000	20	Disable		0	0	1944	2592	Disable	Small	Disabled
9	10000	20	Disable		0	0	1944	2592	Disable	Small	Disabled
10	10000	20	Disable		0	0	1944	2592	Disable	Small	Disabled

Morphology Operation, Morphology Size, and Symbol Type are Processing Settings values.

Save Current Settings to Configuration Database

Definition: Allows current, active configuration settings to be saved to a selected database index.

Serial Cmd: <K255+,index>

Example:

<K255+,5>

This command phrase saves the reader's current, active configuration settings to database index 5.

Save Current Settings to Configuration Database by ESP

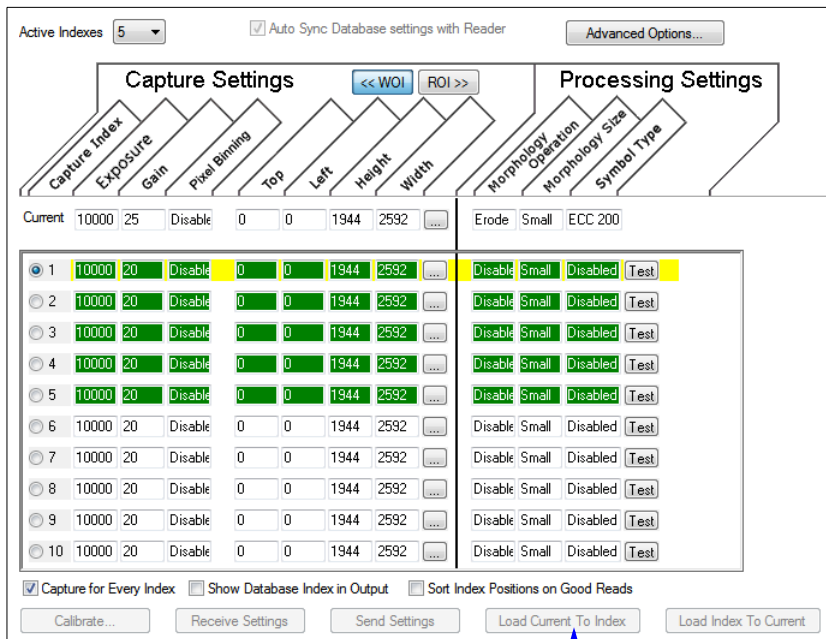

Click the **Load Current to Index** button to save the reader's current configuration parameters to the selected database index.

Load Current Settings from Configuration Database

Definition: Allows the configuration settings contained in a selected database index to be loaded to current, active configuration settings.

Serial Cmd: <K255-,index>

Example:
<K255-,5>

This command phrase loads the configuration settings contained in database index 5 to current, active configuration settings.

Load Current Settings from Configuration Database by ESP

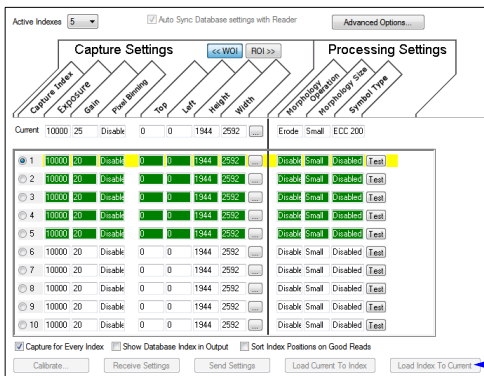

Click the **Load Index to Current** button to load configuration settings from the selected index to current, active settings.

Notes on Symbol Type

- The **current** DataBar Expanded status does not change if it is configured as Enabled (Stacked) and the **database** DataBar Expanded status is Enabled.
- The **current** DataBar-14 status does not change if it is configured as Enabled (Stacked) and the **database** DataBar Expanded status is Enabled.
- Data Matrix ECC level is determined by the **current** settings and not by **database** settings. Therefore, the database does not know which ECC level to enable, and has no effect on current Data Matrix ECC settings.

Request Selected Index Settings

Definition: Returns configuration settings for the selected database index.

Serial Cmd: <K255?,index>

Example:

<K255?,5>

This command phrase returns the configuration settings for database index 5.

Request All Configuration Database Settings

Definition: Returns configuration settings for all indexes in the Configuration Database.

Serial Cmd: <K255?>

Example:

<K255?>

This command phrase returns the configuration settings for all 10 database indexes.

Request All Configuration Database Settings



12 Terminal

Contents

- Terminal 12-2
- Find 12-3
- Send 12-4
- Macros..... 12-5
- Terminal Menus..... 12-6

This section describes the **Terminal** window and macro functions in **ESP**.

Terminal

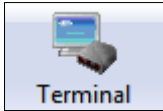

Click this button to display the **Terminal** view.

This view will appear:

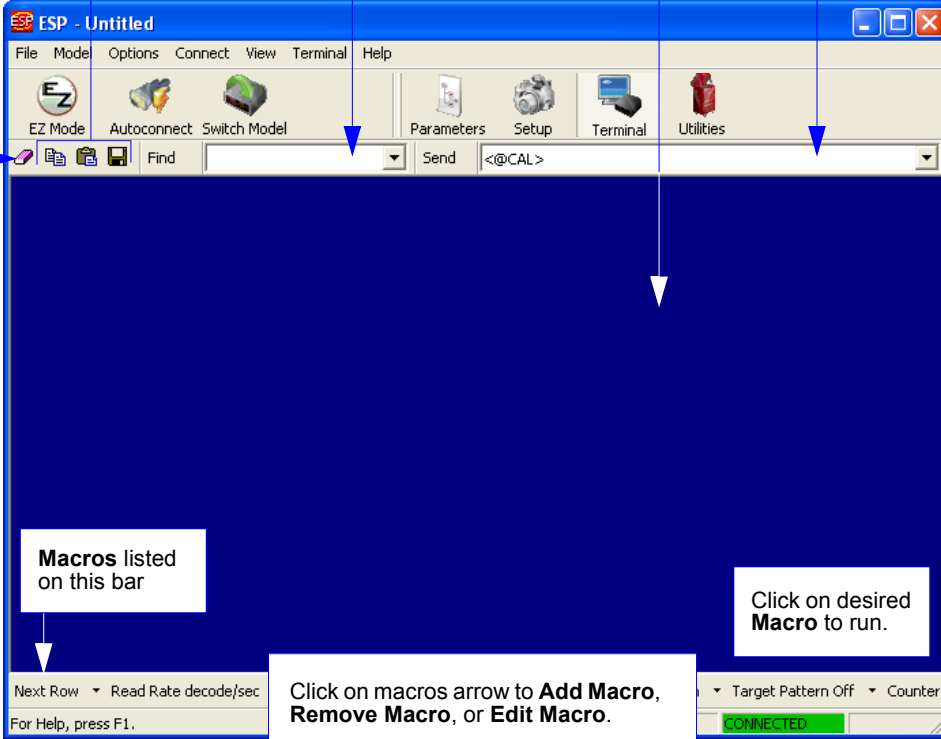

The screenshot shows the ESP software interface with the Terminal view active. The interface includes a menu bar (File, Model, Options, Connect, View, Terminal, Help), a toolbar with icons for EZ Mode, Autoconnect, Switch Model, Parameters, Setup, Terminal, and Utilities, and a main window with a blue background. A 'Send' text field at the top contains '<@CAL>'. A 'Macros' bar at the bottom lists macros and includes a 'Next Row' dropdown, 'Read Rate decode/sec', and a 'Counter' dropdown. A 'CONNECTED' status bar is visible at the bottom right.

Copy, paste, save

Clear screen

Type text here to find matching text in the **Terminal** window.

Terminal screen

Type serial commands here.

Macros listed on this bar

Click on desired **Macro** to run.

Click on macros arrow to **Add Macro**, **Remove Macro**, or **Edit Macro**.

The **Terminal** screen allows you to send serial commands to the reader by using macros, by copying and pasting, or by typing commands in the **Send** text field.

The **Terminal** screen also displays symbol data or information from the reader.

You can also right-click on the **Terminal** screen to bring up a menu of further options.

Find

The **Find** function allows you to enter text strings to be searched for in the **Terminal** window. For example, a series of symbols have been scanned into the **Terminal** view and you want to determine if a particular symbol whose data begins with “ABC” has been read.

1. Type “ABC” into the **Find** box.



2. Press **Enter**.

The first instance of “ABC” will be highlighted in the **Terminal** window.

3. Click the **Find** button to the left of the text field to locate additional instances of “ABC”.

Send

The **Send** function allows you to enter serial commands and then send them to the reader.

1. Type the command into the **Send** box.

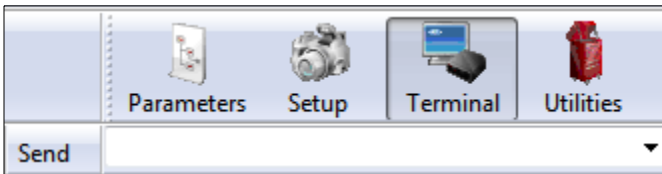

2. Press **Enter**.
3. Click the **Send** button to the left of the text field to send .

Macros

Macros can be stored in a macro selection bar, edited in a separate window, and executed by clicking on the macro name.

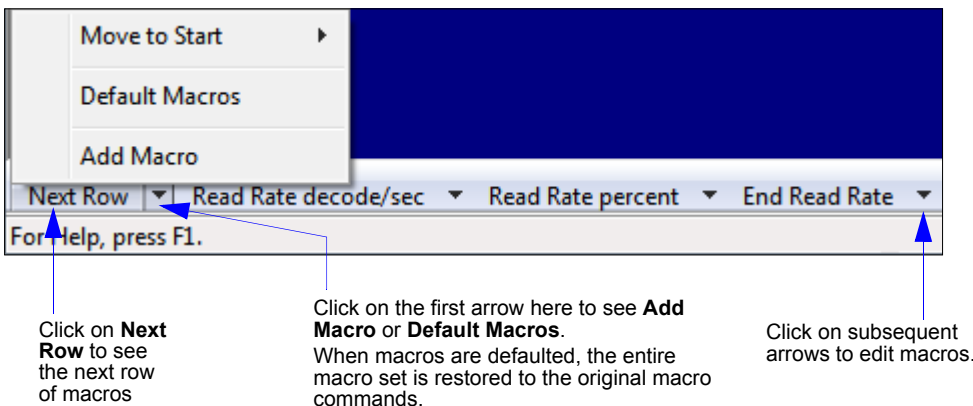

When you click on the macro name, the macro is executed in the **Terminal** window. If this is a command, it is sent to the reader at the same time that it is displayed.

Editing a Macro

When you click the arrow next to any macro and select **Edit**, the following appears:

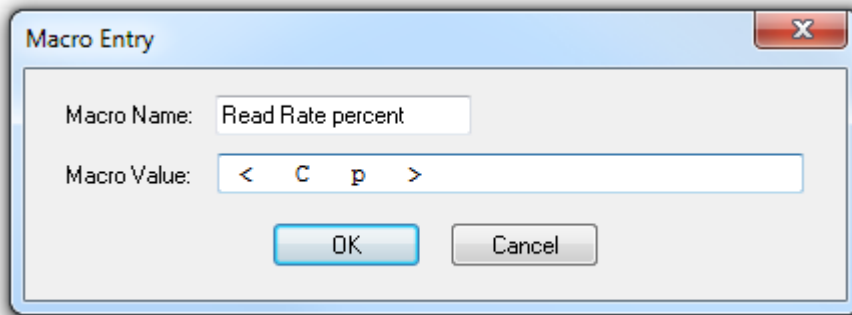

You can edit an existing macro or type in the **Macro Name** text field and define it in the **Macro Value** text field. Click **OK**.

Terminal Menu

Right-click on the **Terminal** window to display the following menu:

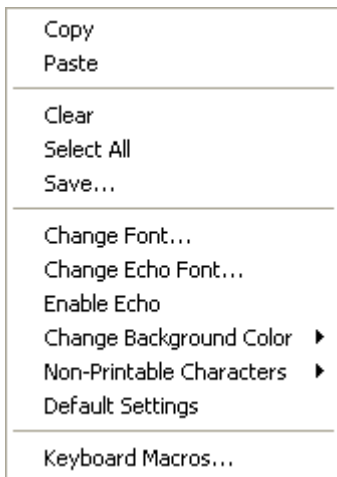

- **Copy** selected text to clipboard.
- **Paste** from Terminal or other text.
- **Clear** all text in Terminal window.
- **Select All** text in the Terminal window.
- **Save...** brings up a **Save As** dialog.
- **Change Font...** of text in Terminal; brings up a **Font** dialog.
- **Change Echo Font...** to change typed text; brings up a **Font** dialog.
- **Enable Echo** enables Echo text (typed by user).
- **Change Background Color** of Terminal window.
- **Non-Printable Characters** allows you to hide non-printable characters, or to show them in **Standard** or **Enhanced** format.
- **Default Settings** returns all the above settings to default.
- **Keyboard Macros** allows you to create new keyboard macro commands that can be sent from function keys (F2, F4, F5, etc.)

Terminal Dropdown Menu

The dropdown **Terminal** menu has **Capture Text**, **Save Current Text**, **Send File**, **Find Next**, and **Find Previous** functions, as well as the same functions defined above.

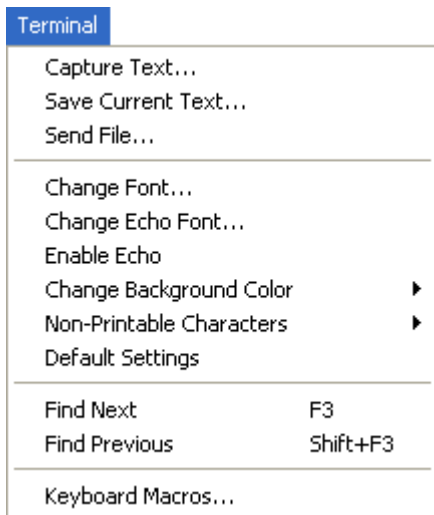

- **Capture Text...** lets you append data in real time to a text file of your choice. While in operation, the text file cannot be opened. You can select Pause to interrupt the capture flow or Stop to end the flow and open the file.
- **Save Current Text...** saves all text in the Terminal window to a text file.
- **Send File** allows you to browse for specific files and send them to the reader.
- **Find Next** searches for a user-defined section of text in the Terminal.
- **Find Previous** operates in the same way as Find Next, but searches backward through Terminal text.

13 Utilities

Contents

Operational Commands.....	13-2
Read Rate	13-4
Counters	13-6
Device Control.....	13-8
Differences from Default.....	13-9
Master Database	13-10
Firmware.....	13-16
Default/Reset/Save.....	13-19
Reader Status Requests	13-21
Other Operational Serial Commands	13-23

Utility commands are generally commands that are performed during reader operations to check or determine read rates, or to perform miscellaneous operations on reader hardware. Serial utility commands are not prefaced with a “**K**” and a numeric code, nor do they require an initialization command (<**A**> and <**Z**>). They can be entered from within any terminal program or from **ESP’s Terminal** or **Utilities** windows.

Operational Commands

Note: For a list of all K commands, see **Serial Configuration Commands**.

Type	Command	Name
Counter Request/Clear	<q>	No-Reads Per Read Cycle Counter
	<q0>	No-Reads Per Read Cycle Counter Reset
	<\$>	Mismatch Per Read Cycle Counter
	<\$0>	Mismatch Per Read Cycle Counter Reset
	<N>	No-Read Counter
	<O>	No-Read Counter Reset
	<T>	Trigger Counter
	<U>	Trigger Counter Reset
	<V>	Match Code Counter
	<W>	Match Code Counter Reset
	<X>	Mismatch Counter
<Y>	Mismatch Counter Reset	
Firmware Verification	<#>	Request All Part Numbers
	<#a>	Request Application Firmware Part Number
	<#b>	Request Boot Code Firmware Part Number
	<!>	Request All Firmware Checksums
	<!a>	Request Application Firmware Checksum
	<!b>	Request Boot Code Firmware Checksum
	<!s>	Request Current Parameter Settings Checksum
Read Rate	<C>	Decodes Per Second Test
	<Cp>	Decode Percent Test
	<J>	Exit Read Rate Tests
	<a1>	Preface PDF417 Output with Data Attributes
Device Control	<L1>	Pulse Programmable Output 1
	<L2>	Pulse Programmable Output 2
	<L3>	Pulse Programmable Output 3
Read Cycle Enable/Disable	<I>	End Current Read Cycle until <H>
	<H>	Enable Read Cycle after <I>
	<I1> ¹	Activate Targeting System
	<I0> ²	Deactivate Targeting System
Parameter Reset/Save	<A?/1>	Complete Reset when Resets or Save for Power-On Command Has Been Issued
	<A?/0>	Warm Reset if Power-On Command Has Been Issued
Resets	<A>	Software Reset, Current Parameters Retained
	<Ard>	Software Reset, Recall Microscan Default Parameters except Communication and Custom Unit Name Parameters
	<Arp>	Software Reset, Recall Power-On Default Parameters
	<Arc>	Software Reset, Recall Customer Default Parameters

¹<I1> = lowercase 'L', one

²<I0> = lowercase 'L', zero

Save for Power-On	<Z>	Software Reset, Save Current Settings for Power-On
	<Zc>	Software Reset, Save Current Settings as Customer Default Parameters
	<Zrc>	Software Reset, Recall Customer Default Parameters and Save for Power-On
	<Zrd>	Software Reset, Recall Microscan Default Parameters Except Communication and Custom Unit Name Parameters and Save for Power-On
	<Zrdall>	Software Reset, Recall Microscan Default Parameters Including Communication and Custom Unit Name Parameters and Save for Power-On
Master Database	<G>	Store Next Symbol Read to Database Index 1
	<Gn>	Store Next Symbol Read to Database Index <i>n</i>
	<NEWM>	New Master Load Status
Reader Status	<?>	Reader Status Request
Train/Optimize	<TRAIN>	Initiate Train Operation
	<UNTRAIN>	Initiate Untrain Operation
	<TRAIN?>	Train Status Request
	<OPT>	Initiate Optimize Operation
	<UNOPT>	Initiate Un-Optimize Operation
Barcode Configuration	<OPT?>	Display Optimize Status
	<BCCFG>	Enter Barcode Configuration

Read Rate

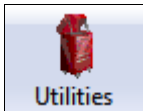

Click the **Utilities** button and then the **Read Rate** tab to display the Read Rate view.

Read Rate information is displayed in the lower portion of the Utilities view. Serial commands can also be sent to the reader from this screen.

To see the **number** of decodes per second, click the **Decodes/sec** radio button and then the **Start** button.

To see the **percentage** of decodes, click the **Percent** radio button and then the **Start** button.

To end a Read Rate test, click the **Stop** button (the Start button becomes a Stop button during an active Read Rate test.)

Read Rate Serial Utility Commands

Enter Decodes/Second Test

Sending **<C>** instructs the reader to transmit the decodes per second and symbol data (if any). The decode rate can vary dramatically due to the angle and location of the symbol in relation to the field of view. This test is very useful in aligning and positioning the reader during setup.

Enter Percent Test

Sending **<Cp>** instructs the reader to transmit the percentage of decodes and any decoded symbol data.

End Read Rate Test

Sending **<J>** ends both the Percent test and the Decodes/Second test.

Counters

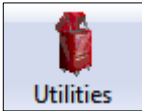

Click the **Utilities** button and then the **Counters** tab to display the Counters view.

Counter commands can be a numeric value from **00000** to **65535**. After reaching the maximum numeric limit of 65535, an error message will be displayed and the counter will automatically roll over and start counting again at 00000. To obtain the cumulative total of counts after the rollover has occurred, add 65536 per each rollover (the reader does not keep track of the number of rollovers) to the current count.

Note: All counter values will be lost if power is cycled, or if the reader receives a **Reset** or **Save** command.

Click the **Request** button to display the appropriate count or **Clear** to set the counter to zero.

The screenshot shows a software interface with a tabbed menu at the top containing: Read Rate, Counters (selected), Device Control, Differences, Master Database, and Firmware. Below the tabs are two large buttons: "Request All" and "Clear All". Underneath these are four rows of controls. Each row has a "Request" button on the left and a "Clear" button on the right. To the right of each pair of buttons is a text label followed by an input field: "Trigger:", "Good Read:", "No Read:", and "Mismatch:". A callout box with a blue border points to the input fields and contains the following text: "Trigger, Good Read, No-Read, and Mismatch counters can be requested and cleared simultaneously (**Request All** and **Clear All** buttons) or individually (**Request** and **Clear** buttons to the left of each item)."

Counters by Serial Command

No-Read Counter

Sending <N> displays the total number of No-Reads that have occurred since the last reset.

No-Read Counter Reset

Sending <O> sets the No-Read Counter to 00000.

Trigger Counter

Sending <T> displays the total number of triggers since the last reset.

Trigger Counter Reset

Sending <U> sets the trigger counter to 00000.

Good Read/Match Counter (or Good Read Counter)

Sending <V> displays the total number of good reads matching the master symbol, or, if **Master Symbol** is not enabled, the number of good reads since the last reset. This counter is always enabled, but will only work as a match count when **Master Symbol** is enabled. If **Master Symbol** is not enabled, this counter records the number of good reads. This count can be requested at any time.

Good Read/Match Counter Reset

Sending <W> sets the Match Counter to 00000.

Mismatch Counter

Sending <X> displays the number of decoded symbols since the last reset that do not match the master symbol.

Mismatch Counter Reset

Sending <Y> sets the Mismatch Counter to zero.

Device Control



Click the **Utilities** button and then the **Device Control** tab to display the Device Control view.

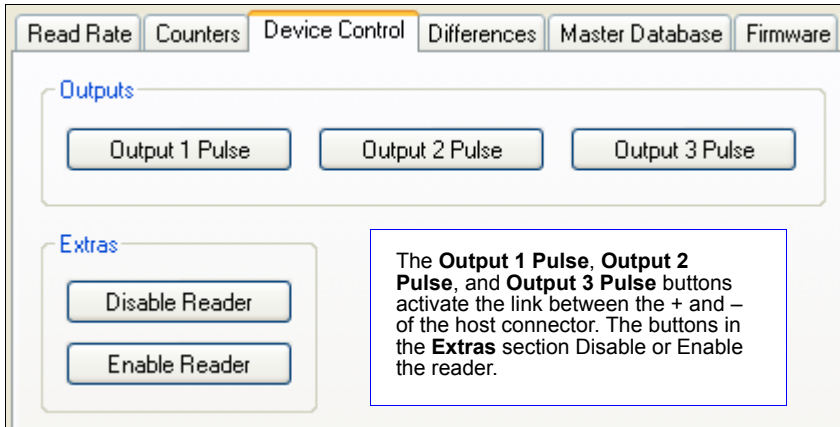

Device Control by Serial Command

Output 1 Pulse

Sending **<L1>** activates the link between Output 1 (+) and Output 1 (-) of the host connector (regardless of Master Symbol or Output 1 status).

Output 2 Pulse

Sending **<L2>** activates the link between Output 2 (+) and Output 2 (-) of the host connector (regardless of Master Symbol or Output 2 status).

Output 3 Pulse

Sending **<L3>** activates the link between Output 3 (+) and Output 3 (-) of the host connector (regardless of Master Symbol or Output 3 status).

Disable Reader

Sending **<I>** will turn the reader OFF, end the current read cycle, and will not allow the reader to enter another read cycle until turned ON. This feature is useful during extended periods of time when no symbols are being decoded, or the reader is being configured. Disabling the reader will not affect any commands that have already been downloaded.

Enable Reader

Sending **<H>** will turn the reader ON and allow it to enter read cycles.

Differences from Default



Click the **Utilities** button and then the **Differences** tab to display the Differences from Default view.

Clicking the **Differences from Default** button will cause **ESP** to check all stored configuration settings and compare them to default settings. All settings that are different than default will appear in the left column (shown below), and descriptions of those settings will appear in the right column.

Click this button for a list of **ESP** configuration settings that are different than default settings.

Click **Generate Barcode** to display the **Bar Code Dialog**. Then create configuration symbols containing the required configuration commands.

The screenshot shows the 'Differences' tab selected in the software interface. The table below lists configuration settings that differ from the default:

Command	Description
<K200,3>	Mode (External Edge)
<K220,,50>	Read Cycle Timeout (50)
<K474h,2>	Code 128 (Edge to Edge)
<K810,3>	Output On (No Read)
<K811,1>	Output On (Good Read/Match)
<K812,2>	Output On (Mismatch)

Callout boxes provide the following instructions:

- Differences from Default**: Click this button for a list of **ESP** configuration settings that are different than default settings.
- Generate Bar Code**: Click **Generate Barcode** to display the **Bar Code Dialog**. Then create configuration symbols containing the required configuration commands.
- Send to Reader**: Send configuration settings to the reader without saving by clicking **Send to Reader**.
- Save As...**: Click **Save As** to save the report as plain text or a tab-delimited text file.
- Send and Save**: Send configuration settings to the reader and save them in ESP by clicking **Send and Save**.

- To create a symbol containing any of the command settings in the table, click **Generate Barcode**.
- To save the **Differences from Default** report, either as plain text or as a tab-delimited text file, click **Save As**.
- Click **Send and Save** to send the settings to the reader and save them, or **Send to Reader** to send the settings without saving them.

Important: To use **Differences from Default**, connect to the reader and **Receive Reader Settings** via the **Send/Recv** button on the toolbar.

Master Database



Click the **Utilities** button and then the **Master Database** tab to display the Master Database view.

Important: The **Master Database** is used for all **Matchcode** modes except **Sequential** and **Wild Card**, both of which use **Master Database Index # 1**.

Master Database Overview

Used where more than one master symbol is required, as in a **Multisymbol** setup, for matching and other **Matchcode** operations.

Allows the user to define up to 10 master symbols as the master symbol database, which can be entered by keyboard, scanned in, displayed, or deleted by serial or **ESP** commands.

1. Click the **Master Database** tab.
2. Enable **Matchcode Type**.
3. Set the **Master Symbol Database Size**.
4. Select the database index in which the master symbol will be entered.
5. Do one of the following to enter master symbol data:
 - a. Double-click the index row to type data directly into the index.
 - b. Click the **Read Symbol into Selected Index** to enter the next decoded symbol.

The screenshot shows the 'Master Database' configuration window. It includes a 'Master Symbol Database Size' field set to 5, a 'Matchcode Type' checkbox which is checked, and buttons for 'Read Symbol into Selected Index', 'Receive Reader's Database', and 'Send Database to Reader'. Below these is a table with 5 rows, each representing a master symbol index. A callout points to the 'Read Symbol into Selected Index' button, stating it loads the next symbol decoded into the selected index. Another callout points to the 'Send Database to Reader' button, stating it saves the database to the reader. A third callout points to the 'Receive Reader's Database' button, stating it loads the reader's saved master symbols into ESP. A fourth callout points to the table rows, stating to double-click a row to enter data into a popup text box. A fifth callout points to the 'Master Symbol Database Size' field, stating to set the size here. At the bottom, a caution note states that changes to the size will re-allocate characters and could delete existing symbols.

Set **Master Symbol Database Size** here.

Loads the next symbol decoded into the selected index.

Loads the reader's saved master symbols into **ESP**.

Saves the database to the reader.

Double-click a row to enter data into popup text box.

Caution: Since the total number of characters available for the master symbol database is limited, changes to the Master Symbol Database Size will re-allocate the number of characters available for each master symbol and could cause existing master symbols to be deleted. See manual for details.

Master Symbol Database Size

Definition: **Number of Master Symbols** allows you to select **1 to 10** master symbols for the master symbol database.

Serial Cmd: <K231,*master symbol database size*>

Note: You must follow this command with a save command <A> or <Z>.

Default: 1

Options: 1 to 10

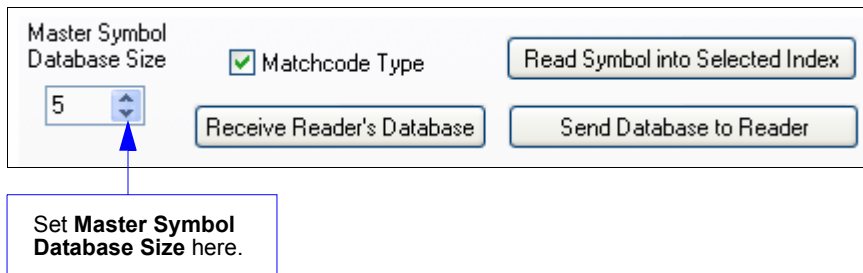

Master Symbol Database Size: 5

Matchcode Type

Read Symbol into Selected Index

Receive Reader's Database

Send Database to Reader

Set Master Symbol Database Size here.

Caution: Since the total number of characters available for the master symbol database is **3000**, changes to the **Master Symbol Database Size** will re-allocate the number of characters available for each master symbol and could cause existing master symbols to be deleted (except master symbol #1, unless it also exceeds the size limitation).

The table below specifies the maximum number of characters available to each symbol according the number of master symbols defined, from 1 to 10.

<i>Master Symbol Number</i>	<i>Maximum Characters</i>	<i>Master Symbol Number</i>	<i>Maximum Characters</i>
# 1	3000	# 6	500
# 2	1500	# 7	428
# 3	1000	# 8	375
# 4	750	# 9	333
# 5	600	# 10	300

Enter Master Symbol Data

Usage: Allows you to enter master symbol data for any enabled master symbol index number (1 to 10), provided the total number of characters does not exceed the maximum allowed.

Serial Cmd: <K231, master symbol number, master symbol data>

Options: Enter data for 1 to 10 symbols (any combination of ASCII text up to the maximum allowed).

For example, to enter data for master symbol 9, after making certain that master symbol database size is enabled for 9 or more symbols, send <K231,9,data>.

Important: The ASCII characters <, >, and , can only be entered as hex values.

Caution: If no data is entered, the existing data will be deleted.

ESP:

1. Open the **Utilities** menu.
2. Set the number of master symbols you want to create in **Master Symbol Database Size**.
3. Double-click on each symbol number you want to set up and copy, or type your data in the popup dialog and click **OK**.

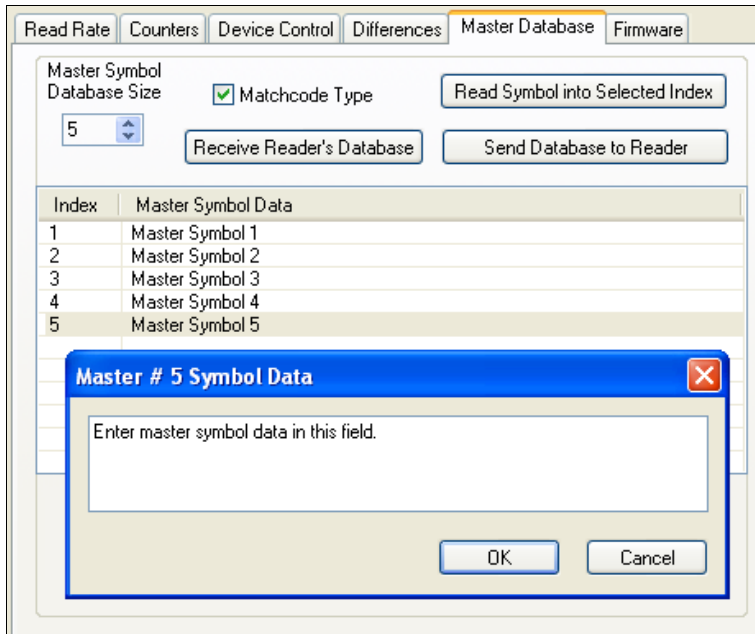

4. When all your data has been entered, click the **Send Database to the Reader** button.

Request Master Symbol Data

Definition: Returns master symbol data for any enabled master symbols from 1 to 10. For example, to request master symbol # 5, enter **<K231?,5>**. The reader transmits master symbol # 5 data in brackets in the following format: **<5/>**. If no master symbol data is available, the output will be: **<5/>**.

Serial Cmd: **<K231?,master symbol number>**

Caution: Be sure to add the ? or you will delete the master symbol.

Note: This command returns the number of master symbols if no number is included.

- ESP:**
1. Click the **Utilities** button and the **Master Database** tab.
 2. Click the **Receive Reader's Database** button.

The screenshot shows a control panel for the Master Symbol Database. It includes a label 'Master Symbol Database Size' and a spinner box containing the number '5'. To the right, there is a checked checkbox labeled 'Matchcode Type'. Below these are three buttons: 'Read Symbol into Selected Index', 'Receive Reader's Database' (which is highlighted with a blue border), and 'Send Database to Reader'.

Request All Master Symbol Data

Definition: This command will return master symbol data for all symbols enabled (up to 10).

Serial Cmd: **<K231?>**

Read Next Symbol as Master Symbol

Definition: After you've set the size in the database, you can order the reader to read the next symbol as the master symbol for any given master symbol number.

Serial Cmd: **<Gmaster symbol number>**

To store the next symbol decoded as master symbol # 1, send:

<G> or **<G1>**.

To store the next symbol decoded as the master symbol for any other master symbol database number, send:

<Gmaster symbol number [1-10]>.

For example, **<G5>** will cause the next symbol read to be entered as master symbol # 5.

ESP: In the **Master Database** tab under the **Output Format** menu,

1. Select the master symbol index number in which you want to store the symbol data.
2. Click the **Read Symbol into Selected Index** button.

Caution: If you've selected an index which already has existing data, that data will be copied over by new decoded data when you use this command.

Request New Master Status

Usage: Informs the user when a new master symbol is pending and which position it is in.

Definition: Returns the position in the master symbol database that will be loaded on the next read.

Serial Cmd: **<NEWM>**

The reader returns: **<NEWM/next master to load>**

Once a symbol has been read and loaded, the status will be cleared and the response will be **<NEWM/0>**.

(See also **New Master Pin** in **Matchcode**.)

Delete Master Symbol Data

Definition: You can directly delete the master symbol data by serial command or by **ESP**.

- ESP:**
1. Click the **Utilities** button to access the master symbol.
 2. Click the **Master Database** tab and double-click the symbol number you want to delete.
 3. Delete text and click **OK**.

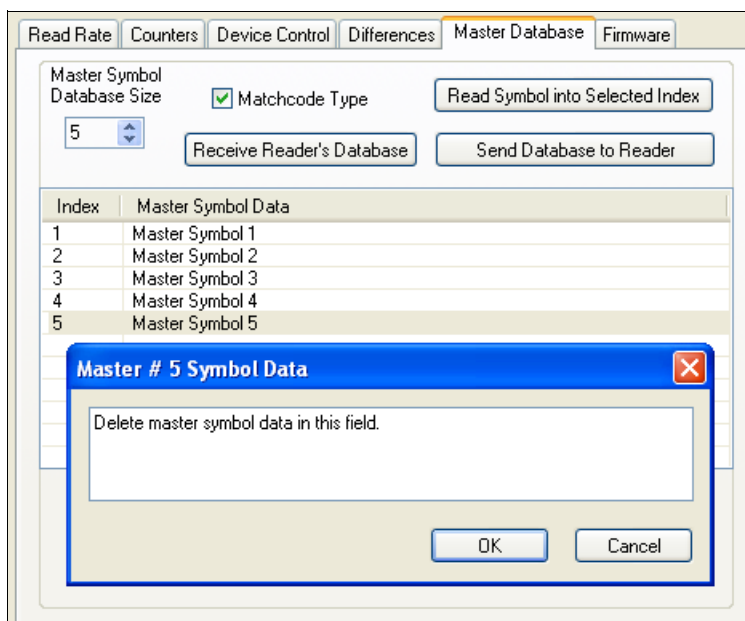

Serial Cmd: <K231,master symbol number,>

To delete a master symbol, enter the database number and a comma, but leave the data field empty. For example, to delete master symbol # 5, send the following: <K231,5,>. The command is entered with a blank master symbol data field, which tells the reader to delete the selected master symbol from the database.

Firmware

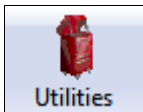

Click the **Utilities** button and then the **Firmware** tab to display the Firmware view.

The screenshot shows a software interface with a top navigation bar containing tabs: Read Rate, Counters, Device Control, Differences, Master Database, and Firmware. The Firmware tab is active. Below the tabs, there are two main sections. The first section, titled 'Firmware Update', contains a dropdown menu labeled 'App Code' and a button labeled 'Start...'. The second section, titled 'Firmware Verification', contains two rows of controls. Each row has a dropdown menu labeled 'App Code', a button labeled 'Request Part No.' or 'Request Checksum', and an empty text input field.

Firmware Update

Application code versions are specific to your reader. Consult with your sales representative before downloading application code. If needed, an application code file will be sent to you.

To download application code:

1. First, be sure that your reader is connected to the host.
2. Apply power to the reader.
3. Before updating, you should verify the current firmware.
4. Click in the Firmware Update text box and select the file type you want to download. This will open a file locator box.
5. Navigate to the appropriate file, open the file and click **Start**.

Caution: Do not interrupt power or disconnect the host cable while download is in progress. Be sure that each download is complete before moving on to the next.

Important: When updating firmware, be sure that the application code and boot code versions are mutually compatible.

Firmware Verification

Request Part Number by ESP

You can send a request to the reader for part numbers, checksums, boot code, and application code.

1. Click the **Firmware** tab.
2. From the dropdown selection box to the left of the **Request Part No.** button, make your selection.
3. Select the code type to see its part number displayed in the text field to the right of the **Request Part No.** button.

The screenshot shows a 'Firmware Verification' panel with two rows of controls. Each row consists of a dropdown menu labeled 'App Code', a button, and an empty text field. The top row's button is 'Request Part No.' and the bottom row's button is 'Request Checksum'. The 'Request Part No.' button is highlighted with a blue border.

Request Part Number by Serial Command

- When you send **<#>** (a request for all product part numbers), the reader returns: **<#b/BOOT_P/N><#a/APP_P/N><#p/PROFILE_P/N>**.
- When you send **<#a>** (a request for the application code part number), the reader returns: **<#a/APP_P/N>**.
- When you send **<#b>** (a request for the boot code part number), the reader returns: **<#b/BOOT_P/N>**.
- When you send **<#p>** (a request for profile module part numbers), the reader returns: **<#p/PROFILE_P/N>**.

Request Checksum by ESP

You can send a request to the reader for part numbers, checksums, boot code, and application code.

1. Click the **Firmware** tab.
2. From the dropdown selection box to the left of the **Request Checksum** button, make your selection.
3. Select the code type to see its checksum displayed in the text field to the right of the **Request Checksum** button.

The screenshot shows a 'Firmware Verification' panel with two rows of controls. Each row starts with a dropdown menu labeled 'App Code'. The top row has a 'Request Part No.' button followed by an empty text input field. The bottom row has a 'Request Checksum' button followed by an empty text input field. The 'Request Checksum' button and its associated text field are highlighted with a red border.

Request Checksum by Serial Command

- When you send `<!>` (a request for all available firmware checksums), the reader returns: `<!b/BOOT_CHECKSUM><!a/APP_CHECKSUM><!p/PROFILE_CHECKSUM>`
- When you send `<!a>` (a request for the application code checksum), the reader returns: `<!a/APP_CHECKSUM>`
- When you send `<!b>` (a request for the boot code checksum), the reader returns: `<!b/BOOT_CHECKSUM>`
- When you send `<!p>` (a request for profile module checksum), the reader returns: `<!p/PROFILE_CHECKSUM>`

Default/Reset/Save

Understanding and controlling your reader's active, saved, and default settings is critical to its successful operation.

	<i>Function</i>	<i>Serial Cmd</i>	<i>ESP (first, right-click in any menu tree)^a</i>
Resets <i>(not saved for power-on)</i>	Reset	<A>	Save to Reader, Send No Save
	Reset and Recall Microscan Defaults	<Ard>	No
	Reset and Recall Power-On Parameters	<Arp>	No
	Reset and Recall Customer Default Parameters	<Arc>	No
Saved for Power-on	Save Current Settings for Power-On	<Z>	Save to Reader, Send and Save
	Save Current Settings as Customer Default Parameters for Power-On	<Zc>	Save to Reader, Send and Save Customer Defaults for Power-On ^b
	Recall Microscan Default Parameters and Save for Power-On	<Zrd>	No
	Recall Customer Default Parameters and Save for Power-On	<Zrc>	No

a. When you right-click in a menu tree and select **Default Current Menu Settings** or **Default All ESP Settings**, it is important to note that only **ESP** settings are defaulted. To save these defaults to the reader itself, you need to follow up with a **Save to Reader, Send and Save** command.

b. Only available in ESP if enabled under the Options dropdown menu.

Resets

Resets (“A” commands) affect only the current settings (active memory) and are not saved for power-on.

Saved for Power-on

Power-on parameters (“Z” commands) are saved to NOVRAM and recalled and loaded into current parameters when power is cycled to the reader or the <Arp> command is issued.

Defaults

Defaults are Microscan firmware settings or saved customer settings that can be recalled, either by software or hardware reset.

Customer Default Parameters

Customer default parameters (saved by **<Zc>**) are the same set of parameters as power-on parameters but are saved in a different, isolated section of NOVRAM. This allows a user essentially to create a backup set of parameters that can be recalled in the event that the current parameters or power-on parameters have been accidentally changed or are no longer desired.

It is important to note that a hardware default does not affect customer default parameters. For example, a user that has inadvertently changed communication settings and saved them with a **<Z>** command, may not know the correct settings or have the capability to communicate within those settings. By first doing a hardware default to restore the known Microscan defaults, the user can then recall the previous customer saved settings with an **<Arc>** or **<Zrc>** command.

Microscan Default Parameters

Microscan default parameters are contained in the firmware and cannot be changed.

Software Defaults

Microscan default parameters can be recalled (loaded into current settings) with **<Ard>** command or recalled and saved for power-on with the **<Zrd>** command.

Hardware Default

If a software default and reset is not possible, it may be necessary to reset the reader by shorting (connecting) specific pins. This procedure has the same effect as the **<Zrdall>** software command.

Important: For this reset to occur, this command must be executed within 60 seconds of a power-on or a reset.

1. Apply power to the reader.
2. Locate Pin 3 (Default) and Pin 7 (Ground) on the connector. (Access depends on wiring configuration. May require an accessory cable).

Caution: Be certain that the correct pins are located. Connecting the wrong pins could cause serious damage to the unit.

3. Momentarily connect the wires (or pins).
4. Within 3 seconds, disconnect and then reconnect the two wires again.

Reader Status Requests

<?> Status Byte

The reader responds to a status request <?> with a two character hex value, such as <?/22>. To determine status:

1. Look up the binary conversion in the table below.

For example, the first hex **2** would be **0 0 1 0** in binary, as read from binary digits **3** through **0**; the second hex **2** is also **0 0 1 0** as read from binary digits **7** through **4**.

2. Next, enter your binary values from the table below in the “Binary” column next to the appropriate bit.

Bit	Binary	Reader Status
0	0	Command error detected
1	1	Command received
2	0	Communication error detected
3	0	Flash sector unprotect failure
4	0	Host port buffer overflow
5	1	Reader is in a read cycle

3. Under “Binary,” interpret **1s** as true and **0s** as not true. For example, bit 1 has a **1** in the “Binary” column, indicating “Command Received”. Bit 5 is also a **1**, indicating that the “Reader is in a read cycle”.

Hex Value	Binary Bit Digits			
	7	6	5	4
	3	2	1	0
0	0	0	0	0
1	0	0	0	1
2	0	0	1	0
3	0	0	1	1
4	0	1	0	0
5	0	1	0	1
6	0	1	1	0
7	0	1	1	1
8	1	0	0	0
9	1	0	0	1
A	1	0	1	0
B	1	0	1	1
C	1	1	0	0
D	1	1	0	1
E	1	1	1	0
F	1	1	1	1

<K?> All Status Request

This is the fastest way to learn the reader’s current configuration. Sending this request will return the current settings of all commands, starting with the lowest K command value and ending with the highest K command value.

<K??> All Descriptor Status Request

This request will return all current descriptors for every K command, starting with the lowest K command value and ending with the highest K command value.

<K?#> All Range Status Request

This request will return the current settings of all commands within the user-defined range, starting with the lowest user-defined K command value and ending with the highest user-defined K command value.

<Knnn?> Single Status Request

This request will return the value of the variables associated with the requested K command. The request of a single entry of a database command cannot exceed the number of database slots for the specific command.

<Knnn??> Single Descriptor Status Request

This request returns the basic functional description of all fields in the requested K command.

<Knnn?#> Single Range Status Request

This request will return the value range and storage type description of all fields in the requested K command.

<Knnn?*> Display Command Wildcard

This request will return the individual K command status, description, and range for each parameter.

Other Operational Serial Commands

The following serial utility commands can be entered from **ESP's Terminal** or a PLC:

Train and Optimize

Train Symbol

Format: **<TRAIN>**: Initiates a Train operation.

This command will put the product into a mode of operation that will cause it to “train” the next symbol decoded. This mode of operation will remain active until either a symbol is decoded or the call is made to disable the mode and revert back to normal operation. Upon decoding a symbol, the image processing will save pertinent information regarding the target symbol to allow higher readability for the similar symbols.

The data collected by the Train operation can be saved for a power-on condition, using the **<Z>** command.

Un-Train Symbol

Format: **<UNTRAIN>**: Initiates an Un-Train operation.

This command will cause the product to discard any information acquired during a Train operation. The Untrained state can be saved for a power-on condition, using the **<Z>** command.

Train Status

Format: **<TRAIN?>**: Responds with Train Status

This command will return the current status of the TRAIN operation.

Response: **< TRAIN,0>**: Default, not trained

<TRAIN,1>: Train operation in process

<TRAIN,2>: Symbol trained

Train Persistence

The train state and parameters persist the same as ordinary parameters. Examples:

- A unit in the trained state has not been saved. A power cycle will remove any trained state information and the unit will come up in its configured state.
- A unit is saved in a training state. The unit will come from power up in the training state and train the first symbol read.
- A unit is saved in a trained state. The unit will come from power up in the trained state and only read the trained symbol type.
- A trained unit is issued a reset default command **<Ard>**. The unit will return to an untrained state but if power is cycled will return to its saved state.

Optimize Symbol

Format: **<OPT>** Initiates an Optimize operation.

This command will put the product into a mode of operation that will cause it to “optimize” the next symbol decoded. This mode of operation will remain active until either a symbol is decoded or the call is made to disable the mode and revert back to normal operation.

Upon decoding a symbol, the image processing will save pertinent information regarding the target symbol to allow it to be processed quicker and more consistently.

The data collected by the Optimize operation can be saved for a power-on condition, using the **<Z>** command.

Un-Optimize Symbol

Format: **<UNOPT>**: Initiates an Un-Optimize operation.

This command will cause the product to discard any information acquired during a Optimize operation. The Un-Optimized state can be saved for a power-on condition, using the **<Z>** command.

Optimize Status

Format: **<OPT?>**: Responds with Optimize Status

This command will return the current status of the OPT operation.

Response: **<OPT,0>**: Default, not optimized

<OPT,1>: Optimize operation in-process

<OPT,2>: Symbol optimized

Optimize Persistence

The Optimize state and parameters persist the same as ordinary parameters. Examples:

- A unit in the optimized state has not been saved. A power cycle will remove any optimized state information and the unit will come up in its configured state.
- A unit is saved in a optimizing state. The unit will come from power up in the optimizing state and optimize the first symbol read.
- A unit is saved in a optimized state. The unit will come from power up in the optimized state and only read the optimized symbol type.
- A optimized unit is issued a reset default command **<Ard>**. The unit will return to an un-optimized state but if power is cycled will return to its saved state.

Y-Modem Upload Transfer Options

<uy,path,filename>

Y-Modem Download Transfer Options

<dy,path,filename>

Image Library Request

<op,9> Manages files in a selected directory.

<i>File Source</i>	<i>Explanation</i>
(Nothing)	All files in "root" directory
/	All files in "root" directory
/saved	All files in "saved" directory
.	All files in all directories
/del	Deletes all files in the root director
/saved/del	Deletes all files in the saved directory
del*.*	Deletes files in all directories

Bar Code Configuration Mode

Definition: **Bar Code Configuration Mode** is a way of programming the reader by using ECC 200 Data Matrix symbols.

Serial Cmd: <BCCFG>

Bar Code Configuration Mode can be entered in two different ways:

1. By forcing the reader into **Bar Code Configuration Mode** by serial command <BCCFG>.
2. By reading a Data Matrix symbol with a special code word used by ISO/IEC 16022 to signify reader programming. This can be either in a regular read cycle or during a read rate test. Reading this symbol in the calibration routine will have no effect.¹

Once **Bar Code Configuration Mode** has been entered, the Data Matrix symbols can be thought of as serial data. You can configure the reader by printing labels in Microscan's serial command format. Commands are processed as if the data were streamed in through the serial port. The reader will acknowledge the symbol with a green flash, and echo the serial data to the host. If the command causes the reader to produce more serial output, such as serial verification or counter requests, the data will be routed to the host port.

Bar Code Configuration Mode can be exited by any reset <A>, <Z> or <J> command.

The command to exit **Bar Code Configuration Mode** can be included as part of the Data Matrix symbol. For example, try encoding <K200,4><K220,1><J> into a Data Matrix symbol. This configures the reader to enable **Serial Trigger Mode**, to program a new trigger to end the read cycle, and to exit **Bar Code Configuration Mode** with <J>.

Note: When the system is in barcode configuration mode, 2D symbols are allowed to pass through even if the reader only has a 1D license. The system outputs a **Config Code Received** message when the configuration symbol is decoded instead of showing the configuration symbol's actual symbol data. A > character is output to the Terminal to indicate that the system is ready for bar code configuration mode.

1. In normal reading modes, it is required to read a special Data Matrix symbol with a special codeword used by ISO/IEC 16022 to signify reader programming.

14 Output Format

Contents

- Output Format Serial Commands..... 14-2
- Output Format Status 14-3
- Format Assign 14-4
- Format Extract..... 14-5
- Format Insert 14-7
- Output Filter Configuration 14-9
- Number of Filters..... 14-14

This section explains how to control the formatting and filtering of decoded symbol data for output.

Output Format Serial Commands

Format Extract	<K740,output index,start location,length>
Format Insert	<K741,output index,length,hex string>
Format Assign	<K742,symbol number,status>
Format Status	<K743,output format status>
Output Filter Configuration	<K744,filter number,symbology,length,wildcard,placeholder,data, unused,database index>
Ordered Output Filter	<K745,number of filters>

Output Format Status

Definition: This is a global enable/disable parameter. In order to use formatting you must set up the format using the insert and extract commands, and you must also assign a symbol to format using the **Format Assign** command.

Serial Cmd: <K743,output format status>

Default: Disabled

Options: 0 = Disabled 1 = Enabled

Output Format Status Disabled

When **Output Format Status** is set to **Disabled**, output formatting is globally disabled.

Output Format Status Enabled

When **Output Format Status** is set to **Enabled**, output formatting is enabled. However, **Format Assign**, **Format Insert**, and **Format Extract** must be properly set up as well.

Output Format Status by ESP

On the **Output Format** tab, check the **Enable Output Format** box.

The screenshot shows the 'Output Format' configuration window. The 'Output Format' tab is active. The 'Enable Output Format' checkbox is checked. The 'Set Number of Symbols' is set to 1. The 'Output Phrase' section shows 'Preamble: CR', 'Symbol #1' with a QR code, and 'Postamble: CR LF'. There are three checkboxes: 'Enable' (checked), 'Parse' (checked), and 'Enable' (checked). Buttons for 'Parse Symbols...', 'Send and Save', 'Receive', and 'Quality Parameters...' are visible at the bottom. A 'Show Parse Table' link is at the bottom left.

Format Assign

Symbol Number

Definition: **Symbol Number** refers to the number of the symbol to which output formatting will apply. For example, if you wish to enable user-defined formatting to symbol # 2 in a multisymbol read cycle, you would send the command **<K742,2,1>**.

Note that the number of symbols may exceed the format capabilities.

Serial Cmd: **<K742, symbol number, status>**

- Options:** 1 to 10
- 1 = Formatted output status for symbol # 1.
 - 2 = Formatted output status for symbol # 2.
 - ...
 - 10 = Formatted output status for symbol # 10.

Status

Definition: **Status** refers to the user-defined formatting of a selected symbol position in the read cycle result. Note that there is also a global formatting “enable” command that must be set for the formatting to be applied.

Serial Cmd: **<K742, symbol number, status>**

Default: **Disabled**

Options: **0 = Disabled** 1 = Enabled (Assign parameters to specified symbol.)

Format Assign by ESP

Format Extract

Output Index

Definition: **Output Index** refers to the database entry you wish to modify with this command. A formatted output is built by *extracting data from a symbol's original data output* and/or inserting user-defined characters.

It may be helpful to think of individual indexes as positions in the final formatted output you wish to build. Starting with index # 1, enter either an extract or insert command to begin building your desired output string. Then, with the next index number, enter either an extract or insert command to continue building the output string. Continue this process until you are finished building the string.

Serial Cmd: <**K740,output index,start location,length**>

Options: 1 to 100

Start Location

Definition: Defines the location within the symbol data where the character extraction will begin. The first character extracted will also be the first character in the sequence displayed in user-defined output.

Serial Cmd: <**K740,output index,start location,length**>

Default: 0

Options: 1 to *n* (maximum number of characters in the symbol data).

Length

Definition: Defines the length (in consecutive characters) that will be extracted and placed in user-defined output.

Serial Cmd: <**K740,output index,start location,length**>

Default: 0 (disabled; end of format cell array)

Options: 1 to *n* (maximum number of characters in the symbol data).

Format Extract by ESP

The screenshot shows the 'Symbol Parse' dialog box with a table and a callout box. The table has three columns: 'Step', 'Insert Data', and 'Extract Range'. The first row is labeled 'Extract' and has '2-4' in the 'Extract Range' column. A callout box points to this cell with the text: 'The Extract Range function corresponds to the Start Location and Length parameters in the Format Extract serial command.'

Step	Insert Data	Extract Range
Extract		2-4

Sample Symbol:
Original: ABCDEFGHIJKLMNOPQRSTUVWXYZ0123456789
Output: BCD

Sample Symbol:
Original: ABCDEFGHIJKLMNOPQRSTUVWXYZ0123456789
Output: BCD

Buttons: Parse Symbols..., Send and Save, Receive, Quality Parameters..., Add Insert Step, Add Extract Step, Remove Step, Clear All Parsing, OK, Cancel

Multiple character sequences can be extracted and inserted using **Symbol Parse**. In this example, the selected extraction range is characters 2-4. The "Sample Symbol" example on the **Symbol Parse** dialog shows the selected character positions extracted and output as desired. Simultaneously, the data string from the selected symbol is displayed at the bottom left of the **Parse Table**, followed by the user-defined extracted output.

Format Insert

Output Index

Definition: **Output Index** refers to the database entry you wish to modify with this command. A formatted output is built by extracting data from a symbol's original data output and/or *inserting user-defined characters*.

It may be helpful to think of individual indexes as positions in the final formatted output you wish to build. Starting with index # 1, enter either an extract or insert command to begin building your desired output string. Then, with the next index number, enter either an extract or insert command to continue building the output string. Continue this process until you are finished building the string.

Serial Cmd: <**K741**,*output index,length,hex string*>

Options: 1 to 100

Length

Definition: Specifies the length of the user-defined character string that will be inserted. This function is limited to 4 characters per output index, so multiple indexes must be entered in order to insert longer character sequences.

For example, if you wish to insert a 10 character sequence in user-defined output, you would need three commands with consecutive index numbers, where the first two character sequence lengths were 4 and the third was 2.

Serial Cmd: <**K741**,*output index,length,hex string*>

Default: **0** (disabled; end of format cell array)

Options: 1 to 4

Hex String

Definition: Specifies a character string that represents ASCII characters to be inserted in the database entry. Two hex characters are required for every ASCII character to be inserted in the user-defined output string. These two characters comprise the hex (base 16) value of the ASCII character.

For example, if you wanted to enter the three-character sequence "Hj!" you would enter **3** for the length of the string, and a hex sequence of **486921** for the ASCII sequence to be inserted. (48 = H; 69 = j; 21 = !)

Important: Each pair of hex characters represents one ASCII character. Hex character pairs range from 00 to FF. Since you are limited to 4 ASCII characters per insertion per database entry, you are likewise limited to 8 hex characters per insertion per database entry.

Serial Cmd: <**K741**,*output index,length,hex string*>

Default: **NUL** (00 in hex)

Options: 00 to FF (As many as 4 bytes, or hex values.)

Format Insert by ESP

Symbol Parse

Step	Insert Data	Extract Range
Insert		

Sample Symbol:
 Original: ABCDEFGHIJKLMNOPQRSTUVWXYZ0123456789
 Output:

SP SP

SOH	STX	ETX	EOT	ENQ
ACK	BEL	BS	HT	LF
VT	FF	CR	SO	SI
SI	DC1	DC2	DC3	DC4
NAK	SYN	ETB	CAN	EM
SUB	ESC	FS	GS	RS
US	SP			

Click 'Delete' to remove characters.

The **Insert** process is very similar to the **Extract** process, except that **Insert** allows the user to enter characters using the **Insert** calculator (shown above).

Parse Symbols... Send and Save Receive Quality Parameters...

▼ Hide Parse Table

Build Sequence:

Step	Insert Data	Extract Range
Insert	SP SP	
Extract		3 - 5

Sample Symbol:
 Original: ABCDEFGHIJKLMNOPQRSTUVWXYZ0123456789
 Output: CDE

Notice that **Extract** and **Insert** share the same **Parse Table**.

Output Filter Configuration

Definition: Output filtering is a method of providing a set of good read qualifiers and also providing ordered output. There is a filter for up to the first 10 positions in a multisymbol output. The first filter corresponds to the first symbol output at the end of the read cycle. Each filter has settings for the following four parameters: **Symbology**, **Symbol Length**, **Data**, and **Configuration Database Number**.

Serial Cmd: <**K744**,*filter number,symbology,length,wildcard,placeholder,data,unused,database index*>

Rules for Output Filter Configuration

Output Filter Configuration Rule # 1

Each symbol that is decoded must match one of the filters before it can be saved to a read cycle record. There is an exception to this rule, however, when the number of symbols required for a read cycle exceeds the number of active filters. In such a case, unfiltered symbols can be placed into unfiltered output positions.

For example, if the number of symbols required is 6 but there are only 4 active filters, the last 2 positions can be filled by any (unfiltered) qualified symbol.

Output Filter Configuration Rule # 2

The same filter setup can be used multiple times.

For example, filters 1, 2, and 3 can be set up to filter Data Matrix symbols, and the output will occur in the order the symbols are decoded.

Output Filter Configuration Rule # 3

All qualified symbols will be sorted and output in the matching filter position. If a symbol matches filter 3, it will be output as the third symbol. If a filter does not have a matching qualified symbol, a No-Read message will be output in place of the symbol (assuming the No-Read message is enabled).

For example, if there is not a symbol that meets filter 3's requirements, then a No-Read message will be output in the third output position.

Filter Number

Definition: This is the filter index number that represents the position of the symbol in the data output at the end of the read cycle. This index number should be entered along with the following filter settings for the predetermined symbol position.

Serial Cmd: <**K744**,*filter number*, *symbology*, *length*, *wildcard*, *placeholder*, *data*, *unused*, *database index*>

Options: 1 to 10

Symbology

Definition: Specifies the symbology allowed to occupy this location in multisymbol output.
Note: To filter or order a symbol, the symbol must meet all the requirements of the selected filter index.

Serial Cmd: <**K744**, *filter number*, **symbology**, *length*, *wildcard*, *placeholder*, *data*, *unused*, *database index*>

Default: **0** (any symbology)

Options:

- 0 = Any type
- 1 = Interleaved 2 of 5
- 2 = Code 39
- 3 = Code 128
- 4 = Codabar
- 5 = UPC
- 6 = PDF417
- 7 = EAN 128
- 8 = Code 93
- 9 = Pharmacode
- 10 = GS1 DataBar
- 11 = MicroPDF417
- 12 = Composite
- 13 = BC412
- 14 = Data Matrix
- 15 = QR Code
- 16 = Micro QR Code
- 17 = Aztec
- 18 = Postal Symbologies

Length

Definition: Specifies the length of the decoded symbol allowed to occupy this location in multisymbol output.

Note: To filter or order a symbol, the symbol must meet all requirements of the selected filter index.

Serial Cmd: <**K744**, filter number, symbology, **length**, wildcard, placeholder, data, unused, database index>

Default: 0

Options: 0 to 64

Wildcard

Definition: This is the character to be used in the data output field when performing a data filter comparison. The wildcard character represents the end of matching, and allows for variable lengths of symbol output.

Serial Cmd: <**K744**, filter number, symbology, length, **wildcard**, placeholder, data, unused, database index>

Default: “ * ” = **2A** (hex)

Options: Any ASCII input in the form of a pair of hex characters.

Example:

2A = *

00 = disabled

Placeholder

Definition: The placeholder character requires a character to be present, but does not compare the data value.

Serial Cmd: <**K744**, filter number, symbology, length, wildcard, **placeholder**, data, unused, database index>

Default: “ ? ” = **3F** (hex)

Options: Any ASCII input in the form of a pair of hex characters.

Example:

3F = ?

00 = disabled

Data

Definition: This is the data string to be used when comparing symbol data for output filtering and ordering. This data string may also contain wildcard and placeholder characters to facilitate matching. Remember that in order to filter or order symbol data, it must meet all the requirements of the selected filter index.

Examples:

- Filter data = "123*". This will match data strings of "123", "123456", and "123ABC", but not "12".
- Filter data = "123*AB?C". This will be interpreted as "123*".
- Filter data = "123?". This will match "1234" and "123A", but not "123", "12345", or "1234C".
- Filter data = "123?A". This will match "1234A" and "123BA", but not "123", "1234C", or "1234ABCD".
- Filter data = "123?A?". This will match "1234AB" and "123BAT", but not "1234A" or "123BATS".
- Filter data = "12??*". This will match "1234", "123456", and "123ABC", but not "12" or "123".
- Filter data = "123?A*". This will match "1234A", "123BA", and "123BATS", but not "1234" or "1234C".

Serial Cmd: <**K744**, *filter number, symbology, length, wildcard, placeholder, data, unused, database index*>

Default: 00 (NUL)

Options: Any ASCII input in the form of a pair of hex characters.
Maximum length: 63 bytes defined.

Examples:

41422A = AB*

Data [0] = NUL represents string matching disabled.

Database Index

Definition: The index of the database entry that decodes a given symbol must equal this setting for filtering to occur. A setting of 0 allows any database index for this filter entry.

Serial Cmd: <**K744**, *filter number, symbology, length, wildcard, placeholder, data, unused, database index*>

Default: 0 (any index)

Options: 0 to 10

Ordered Output Filter Configuration by ESP

Double-clicking on a row in the Ordered Output table brings up the **Ordered Output Filter Settings** dialog.

Use these settings to determine **Symbology Type**, **Length** of the symbol, a user-defined **Matching String**, **ASCII Lookup**, **Wildcard Character**, **Placeholder Character**, and **Database Number**. Click **Apply** to save the settings to the corresponding filter.

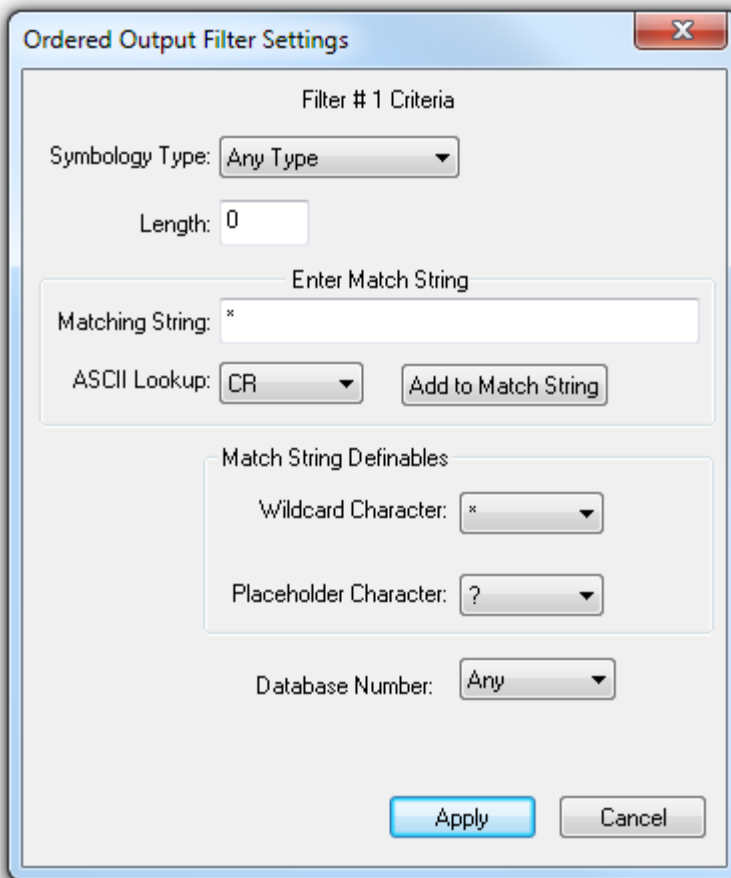

The image shows a dialog box titled "Ordered Output Filter Settings" with a close button (X) in the top right corner. The dialog is divided into several sections:

- Filter # 1 Criteria**:
 - Symbology Type: Any Type (dropdown menu)
 - Length: 0 (text input field)
- Enter Match String**:
 - Matching String: * (text input field)
 - ASCII Lookup: CR (dropdown menu) and Add to Match String (button)
- Match String Definables**:
 - Wildcard Character: * (dropdown menu)
 - Placeholder Character: ? (dropdown menu)
- Database Number: Any (dropdown menu)

At the bottom of the dialog are two buttons: "Apply" (highlighted in blue) and "Cancel".

Number of Filters

Definition: **Number of Filters** refers to the number of active output filters. **0** disables all output filters. Any non-zero numeral will enable filtering to be performed using the filter indexes covered by this value.

For example, if the number of filters is **1**, then only filter index # 1 will be applied. If the number of filters is **2**, then only filter index # 1 and filter index # 2 will be applied, etc.

Serial Cmd: **<K745,number of filters>**

Default: **0**

Options: 0 to 10

Appendices

Contents

Appendix A General Specifications A-2
Appendix B Electrical Specifications A-8
Appendix C Serial Commands A-10
Appendix D Communications Protocol A-12
Appendix E ASCII Table..... A-13
Appendix F Glossary of Terms A-14

Appendix A — General Specifications

MicroHAWK ID-20

Mechanical

Height: 0.95" (24.1 mm)

Width: 1.32" (33.5 mm)

Depth: 1.53" (38.8 mm)

Weight: 0.92 oz. (26 g)

Environmental

Enclosure: IP40

Humidity: 5% to 95% (non-condensing)

Operating Temperature: 0° to 40°C (32° to 104°F)

Storage Temperature: -50° to 75° C (-58 to 167°F)

Illumination

LEDs: 4 Red (625nm), 4 White, 2 Blue (Target Pattern), 2 Green (Green Flash on Good Read)

Light Collection Options

Progressive scan, square pixel; Software-adjustable exposure; electronic shutter; fixed focus, factory-configurable, 50 mm to 300 mm; Standard Density or High Density

WVGA: 752 by 480 pixels (Global Shutter)

SXGA: 1280 by 960 pixels (Global Shutter)

QSXGA: 2592 by 1944 pixels (Rolling Shutter)

Symbologies

2D: Data Matrix (ECC 0-200), QR Code, Micro QR Code, Aztec, DotCode

Stacked: PDF417, MicroPDF417, GS1 DataBar (Composite and Stacked)

Linear: Code 39, Code 128, BC412, Interleaved 2 of 5, UPC/EAN, Codabar, Code 93, Pharmacode, PLANET, POSTNET, Japanese Post, Australian Post, Royal Mail, Intelligent Mail, KIX

Read Parameters

Pitch: ±30° **Skew:** ±30° **Tilt:** 360°

Frames Per Second: 60 (WVGA); 42 (SXGA); 5 (QSXGA)

Decoder: Standard (High-Contrast 1D); Plus (High-Contrast 1D/2D); X-Mode (All 1D/2D and DPM)

Speed: Standard Speed or High Speed

Connector

Micro-USB Type B

Status Indicators

Power-On LED, Green LED flash on Good Read

Communication Interface

USB 2.0

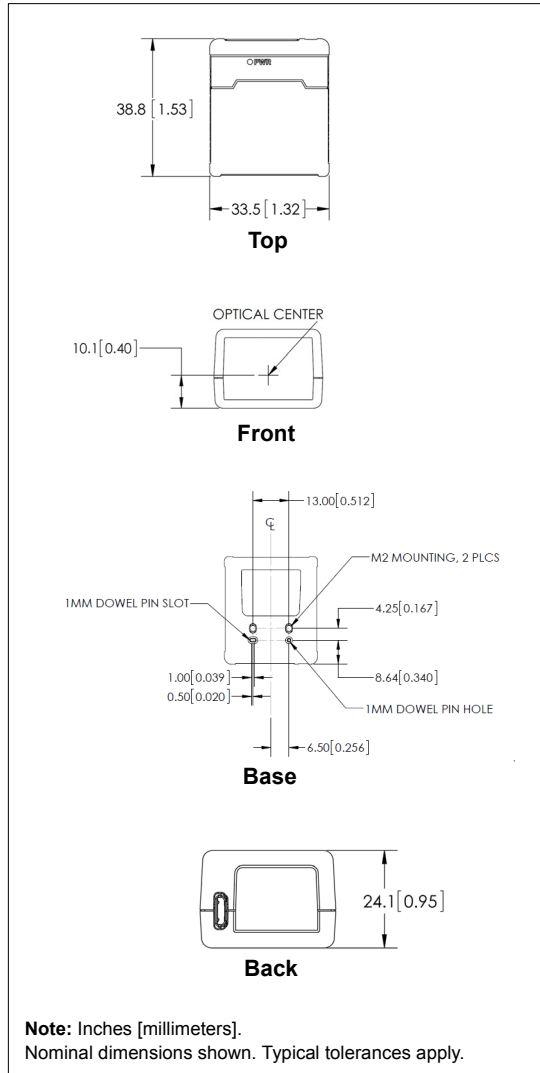

MicroHAWK ID-20 Dimensions

MicroHAWK ID-30

Mechanical

Height: 1.0" (25.4 mm)
Width: 1.75" (44.5 mm)
Depth: 1.5" (38.1 mm)
Weight with Cable: 4.02 oz. (114 g)
Weight without Cable: 1.62 oz. (46 g)

Environmental

Enclosure: IP54
Humidity: 5% to 95% (non-condensing)
Operating Temperature: 0° to 40°C (32° to 104°F)
Storage Temperature: -50° to 75° C (-58 to 167°F)

Illumination

Inner LEDs: 4 Red (625nm), 4 White, 2 Blue (Target Pattern), 2 Green (Green Flash on Good Read)
Outer LEDs: Optional Red (617nm) or White LED Expansion – 8 High-Intensity LEDs

Light Collection Options

Progressive scan, square pixel; Software-adjustable exposure; electronic shutter; fixed focus, factory-configurable, 50 mm to 300 mm; Standard Density or High Density
WVGA: 752 by 480 pixels (Global Shutter)
SXGA: 1280 by 960 pixels (Global Shutter)
QSXGA: 2592 by 1944 pixels (Rolling Shutter)

Symbologies

2D: Data Matrix (ECC 0-200), QR Code, Micro QR Code, Aztec, DotCode
Stacked: PDF417, MicroPDF417, GS1 DataBar (Composite and Stacked)
Linear: Code 39, Code 128, BC412, Interleaved 2 of 5, UPC/EAN, Codabar, Code 93, Pharmacode, PLANET, POSTNET, Japanese Post, Australian Post, Royal Mail, Intelligent Mail, KIX

Read Parameters

Pitch: ±30° **Skew:** ±30° **Tilt:** 360°
Frames Per Second: 60 (WVGA); 42 (SXGA); 5 (QSXGA)
Decoder: Standard (High-Contrast 1D); Plus (High-Contrast 1D/2D); X-Mode (All 1D/2D and DPM)
Speed: Standard Speed or High Speed

Connector

High-Density 15-Pin Dsub

Status Indicators

LEDs: Power, Link (Ethernet), Trigger, Mode, Pass, Fail, Green LED flash on Good Read

Communication Interface

Standard Interfaces: USB 2.0 / Serial / I/O / Power

Discrete I/O

Inputs: Trigger Input: 5-28V rated (0.16mA @ 5VDC); New Master: 5 to 28V rated (0.16mA @ 5VDC); Default: 3.3V rated (0mA @ 3.3V)
Outputs (1, 2, 3): 5V TTL-compatible, can sink 10mA and source 10mA

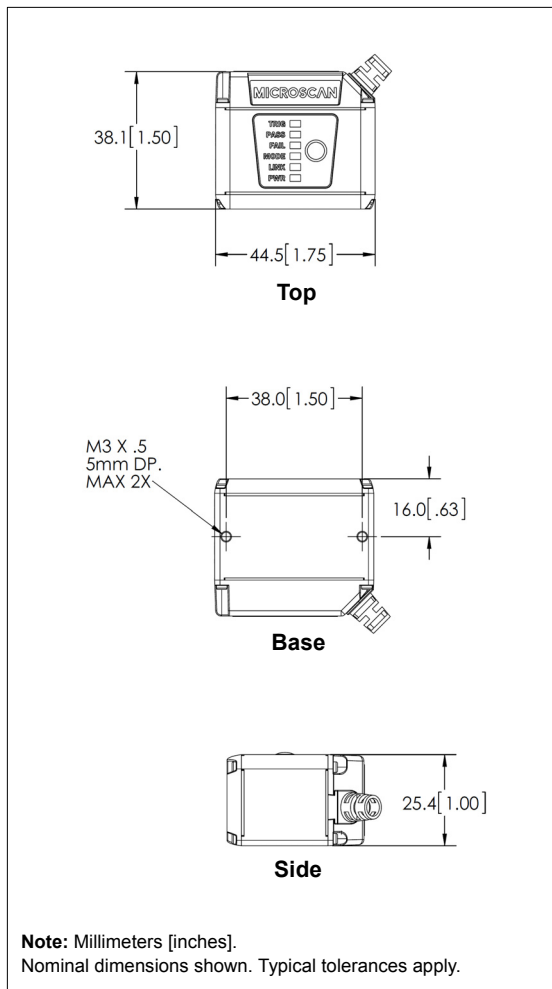

MicroHAWK ID-30 Dimensions

General Specifications

MicroHAWK ID-40

Mechanical

Height: 1.0" (25.4 mm)

Width: 1.75" (44.5 mm)

Depth: 1.75" (44.5 mm)

Weight: 2.40 oz. (68 g)

Environmental

Enclosure: IP65/67

Humidity: 5% to 95% (non-condensing)

Operating Temperature: 0° to 45°C (32° to 113°F)

Storage Temperature: -50° to 75° C (-58 to 167°F)

Illumination

Inner LEDs: 4 Red (625nm), 4 White, 2 Blue (Target Pattern), 2 Green (Green Flash on Good Read)

Outer LEDs: Optional Red (617nm) or White LED Expansion – 8 High-Intensity LEDs

Light Collection Options

Progressive scan, square pixel; Software-adjustable exposure; electronic shutter; fixed focus, factory-configurable, 50 mm to 300 mm; Standard Density or High Density

WVGA: 752 by 480 pixels (Global Shutter)

SXGA: 1280 by 960 pixels (Global Shutter)

QSXGA: 2592 by 1944 pixels (Rolling Shutter)

Symbologies

2D: Data Matrix (ECC 0-200), QR Code, Micro QR Code, Aztec, DotCode

Stacked: PDF417, MicroPDF417, GS1 DataBar (Composite and Stacked)

Linear: Code 39, Code 128, BC412, Interleaved 2 of 5, UPC/EAN, Codabar, Code 93, Pharmacode, PLANET, POSTNET, Japanese Post, Australian Post, Royal Mail, Intelligent Mail, KIX

Read Parameters

Pitch: ±30° **Skew:** ±30° **Tilt:** 360°

Frames Per Second: 60 (WVGA); 42 (SXGA); 5 (QSXGA)

Decoder: Standard (High-Contrast 1D); Plus (High-Contrast 1D/2D); X-Mode (All 1D/2D and DPM)

Speed: Standard Speed or High Speed

Connector

Dual M12 12-Pin (A = Power) and M12 8-Pin (B = Ethernet)

Status Indicators

LEDs: Power, Link (Ethernet), Trigger, Mode, Pass, Fail, Green LED flash on Good Read

Communication Interface

Standard Interfaces: Serial / Ethernet 10/100 / I/O / Power

Discrete I/O

Inputs: Trigger Input; New Master: Bi-directional, optoisolated, 4.5-28V rated (10mA @ 28VDC)

Outputs (1, 2, 3): Bi-directional, optoisolated, 1-28V rated, ($I_{CE} < 100$ mA at 24VDC, current limited by user)

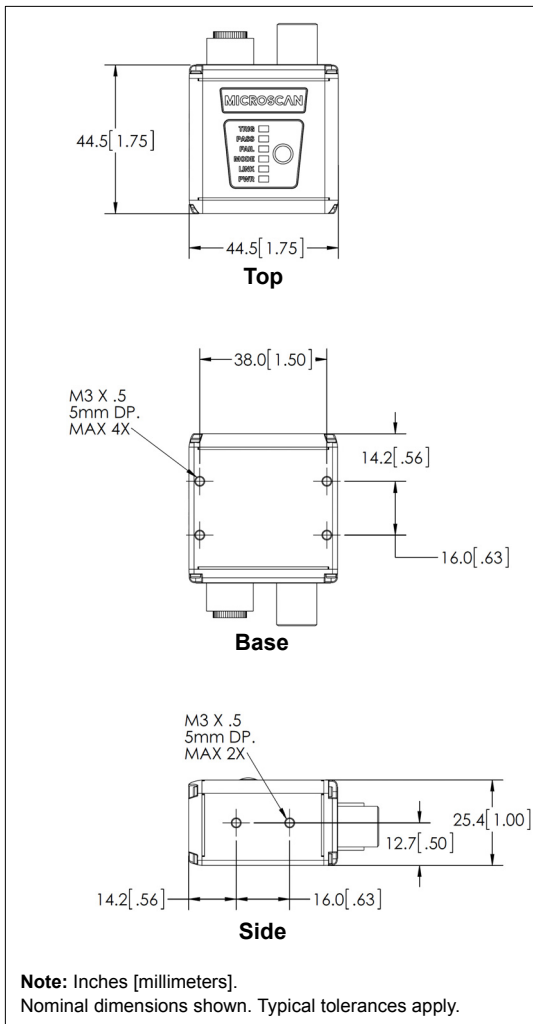

MicroHAWK ID-40 Dimensions

Safety Certifications

FCC, UL/cUL, CE, RoHS/WEEE



©2017 Microscan Systems, Inc.

All rights reserved. Specifications subject to change.

Product specifications are given for typical performance at 25° C (77° F) using grade A symbols. Performance characteristics may vary at high temperatures or other environmental extremes.

Warranty – One year limited warranty on parts and labor. Extended warranty available.

General Specifications

Read Ranges

WVGA High Density							
Focal Distance		Field of View		Typical 2D Mil Size	Depth of Field (mm)		Minimum 2D Mil Size
Inches	Millimeters	Inches	Millimeters		Inside	Outside	
2.0	50	1.4	35	7.5	43	58	5
2.5	64	1.5	38	7.5	55	73	5
3.2	81	1.9	49	10	65	97	7.5
4.0	102	2.6	65	10	83	121	10
5.2	133	3.1	80	15	90	176	10
7.5	190	4.5	114	20	133	246	15
11.8	300	7.1	180	30	179	422	30

WVGA Standard Density							
Focal Distance		Field of View		Typical 2D Mil Size	Depth of Field (mm)		Minimum 2D Mil Size
Inches	Millimeters	Inches	Millimeters		Inside	Outside	
2.0	50	2.0	50	10	38	65	7.5
2.5	64	2.2	55	10	49	78	7.5
3.2	81	2.8	70	15	56	106	10
4.0	102	3.7	94	20	52	152	15
5.2	133	4.5	115	20	78	187	15
7.5	190	6.5	165	30	128	252	20
11.8	300	10.2	260	40	219	381	30

SXGA High Density							
Focal Distance		Field of View		Typical 2D Mil Size	Depth of Field (mm)		Minimum 2D Mil Size
Inches	Millimeters	Inches	Millimeters		Inside	Outside	
2.0	50	1.5	37	5	37	55	3.3
2.5	64	1.6	41	5	58	70	3.3
3.2	81	2.0	52	7.5	70	92	5
4.0	102	2.7	69	7.5	88	116	5
5.2	133	3.4	85	10	107	159	7.5
7.5	190	4.8	122	15	137	243	10
11.8	300	7.6	192	20	185	400	15

SXGA Standard Density							
Focal Distance		Field of View		Typical 2D Mil Size	Depth of Field (mm)		Minimum 2D Mil Size
Inches	Millimeters	Inches	Millimeters		Inside	Outside	
2.0	50	2.1	53	7.5	37	64	5
2.5	64	2.3	59	7.5	49	78	5
3.2	81	2.9	75	7.5	60	102	7.5
4.0	102	3.9	100	10	74	131	7.5
5.2	133	4.8	123	10	88	161	10
7.5	190	6.9	175	15	115	265	15
11.8	300	10.9	277	20	224	427	20

Read Ranges (cont.)

5MP High Density							
Focal Distance		Field of View		Typical 2D Mil Size	Depth of Field (mm)		Minimum 2D Mil Size
Inches	Millimeters	Inches	Millimeters		Inside	Outside	
2.0	50	1.4	35	5	46	55	3.3
2.5	64	1.5	39	5	59	68	3.3
3.2	81	2.0	50	5	74	87	3.3
4.0	102	2.6	66	5	94	110	3.3
5.2	133	3.2	81	7.5	112	153	5
7.5	190	4.6	116	10	154	227	7.5
11.8	300	7.2	184	15	227	373	10

5MP Standard Density							
Focal Distance		Field of View		Typical 2D Mil Size	Depth of Field (mm)		Minimum 2D Mil Size
Inches	Millimeters	Inches	Millimeters		Inside	Outside	
2.0	50	2.0	51	5	43	59	3.3
2.5	64	2.2	57	5	55	72	3.3
3.2	81	2.8	72	5	69	92	5
4.0	102	3.8	96	7.5	80	124	5
5.2	133	4.6	117	7.5	107	159	7.5
7.5	190	6.6	168	10	150	231	10
11.8	300	10.4	265	15	203	397	15

Read range specifications are subject to change.

Appendix B — Electrical Specifications

MicroHAWK ID-20: 5VDC \pm 5%; 350mA at 5VDC (typ.)

MicroHAWK ID-30: 5V \pm 5%; 600mA at 5VDC (typ.)

MicroHAWK ID-40: 4.75V – 30V; 150mA at 24VDC (typ.)

MicroHAWK ID-20 Micro-USB Type B Socket

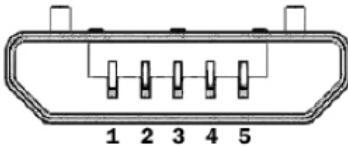

Pin	Function
1	Vbus (5V)
2	D-
3	D+
4	N/C
5	Ground

MicroHAWK ID-30 High-Density 15-Pin Dsub Socket

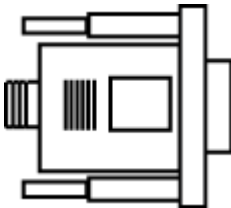

Note: An accessory cable is required between the ID-30's 15-pin corner-exit cable and the host's USB port.

Pin	Function
1	+5VDC
2	TX232
3	RX232
4	GND
5	D+
6	N/C
7	Output 1+
8	Default+
9	Trigger+
10	D-
11	Output 3+
12	Input+ (New Master+)
13	Chassis
14	Output 2+
15	Vbus

MicroHAWK ID-40 M12 Connectors

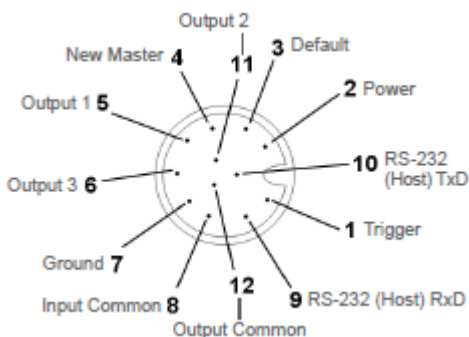

M12 12-pin Plug

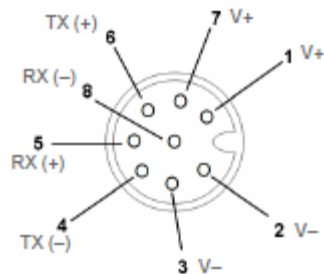

M12 8-pin Socket (Ethernet)

Grounding and Isolation

Important: Mounting an ID-30 or ID-40 reader to grounded conductive material may cause communication problems or unreliable operation. If you need to mount the reader to a bracket or plate, be sure that a proper ground connection is available. If a proper ground is not available, electrical isolation of the reader should be performed. Using Microscan's Isolation Mounting Kit, P/N 98-900064-01, will ensure that no ground loop or other external electrical noise can occur through the reader.

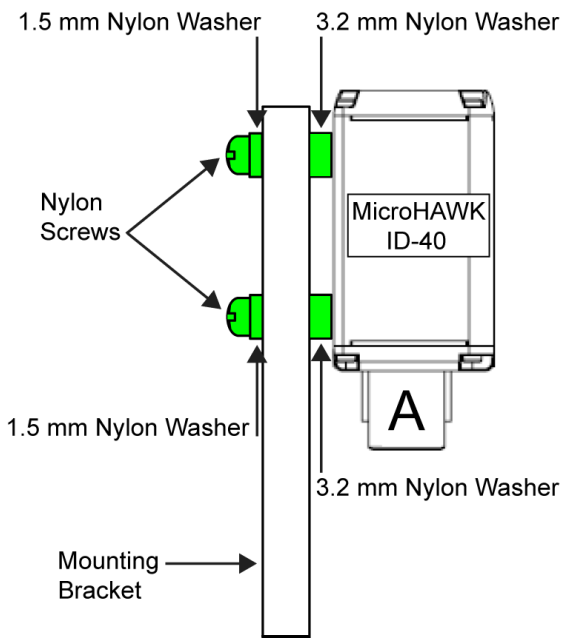

Appendix C — Serial Commands

Serial Command Format

Microscan readers are controlled by two types of serial commands: configuration commands and utility commands.

Rules that apply to both configuration and utility commands

- Less than ‘<’ and greater than ‘>’ angle bracket characters enclose the commands.
- Commands and data are case sensitive. Characters must be entered as upper or lower case, as specified.

Serial Utility Commands

Serial Utility Commands are sent during operations and are not followed by <A> or <Z>.

Serial Configuration Commands (K Commands)

Microscan’s serial configuration commands begin with a single “K” character followed by a 3-digit numeric character, comma-separated command fields, and an initializing command, as follows:

<Knumeric character,data,data,...etc.><initializing command>

An initializing command <Z> or <A> may follow the command.

- <Z> initializes the MicroHAWK Engine’s memory and saves for power-on.
- <A> initializes the MicroHAWK Engine’s memory but does not save for power-on.

For example, to enable **UPC** and save the change for power-on, send <K473,1><Z>.

To change **Baud Rate** and reset without saving changes for power-on, send <K100,3><A>.

Serial Configuration Command Conventions

- All command fields (except the last) must be followed by a comma (without a space).
- NULL cannot be used. The characters <, >, and , can be used, but only if entered as hex values.
- All fields preceding a modified field must be included.
- If there is no change in preceding fields, then commas alone can be entered in these fields. For example, if only the last field in the following command is changing, <K100,4,1,0,0> can be entered as <K100,,,,0>.
- All fields *following* a modified field can be omitted. For example, to change Baud Rate only, send <K100,3>.

Concatenating Configuration Commands

Commands can be concatenated (added together) in a single string. For example, <K145,1><K220,1><K450,1><A> enables **LRC**, sets **End of Read Cycle** mode to **New Trigger**, enables **Narrow Quiet Zone**, and resets the data buffers without saving the changes for power-on.

Serial Command Status Request

To ensure that any command was received and accepted, send the **Show Reader Status** command: **<?>**.

The status of a specific serial command can be requested by entering the command followed by a question mark. For example, send **<K142?>** to request the status of **Postamble**.

Entering Control Characters in Serial Commands

To enter control characters within a serial command, hold down the **Ctrl** key while typing the desired character.

Example: To enter a carriage return and line feed (**^M^J**), enter **<K141,1,CNTL-m CNTL-j>**

Appendix D — Communications Protocol

Communications Protocol Command Table

Protocol Command (Mnemonic displayed on menu)	Control Characters (Entered in menu or serial command)	Hex Value	Effect of Command
RES	^D	04	Reset
REQ	^E	05	Request
EOT	^D	04	Reset
STX	^B	02	Start of Text
ETX	^C	03	End of Text
ACK	^F	06	Acknowledge
NAK	^U	15	Negative Acknowledge
XON	^Q	11	Begin Transmission
XOFF	^S	13	Stop Transmission

Appendix E — ASCII Table

Dec	Hex	Mne	Ctrl	Dec	Hex	Ch	Dec	Hex	Ch	Dec	Hex	Ch
00	00	NUL	^@	32	20	SP	64	40	@	96	60	`
01	01	SOH	^A	33	21	!	65	41	A	97	61	a
02	02	STX	^B	34	22	"	66	42	B	98	62	b
03	03	ETX	^C	35	23	#	67	43	C	99	63	c
04	04	EOT	^D	36	24	\$	68	44	D	100	64	d
05	05	ENQ	^E	37	25	%	69	45	E	101	65	e
06	06	ACK	^F	38	26	&	70	46	F	102	66	f
07	07	BEL	^G	39	27	'	71	47	G	103	67	g
08	08	BS	^H	40	28	(72	48	H	104	68	h
09	09	HT	^I	41	29)	73	49	I	105	69	i
10	0A	LF	^J	42	2A	*	74	4A	J	106	6A	j
11	0B	VT	^K	43	2B	+	75	4B	K	107	6B	k
12	0C	FF	^L	44	2C	,	76	4C	L	108	6C	l
13	0D	CR	^M	45	2D	-	77	4D	M	109	6D	m
14	0E	SO	^N	46	2E	.	78	4E	N	110	6E	n
15	0F	SI	^O	47	2F	/	79	4F	O	111	6F	o
16	10	DLE	^P	48	30	0	80	50	P	112	70	p
17	11	DC1	^Q	49	31	1	81	51	Q	113	71	q
18	12	DC2	^R	50	32	2	82	52	R	114	72	r
19	13	DC3	^S	51	33	3	83	53	S	115	73	s
20	14	DC4	^T	52	34	4	84	54	T	116	74	t
21	15	NAK	^U	53	35	5	85	55	U	117	75	u
22	16	SYN	^V	54	36	6	86	56	V	118	76	v
23	17	ETB	^W	55	37	7	87	57	W	119	77	w
24	18	CAN	^X	56	38	8	88	58	X	120	78	x
25	19	EM	^Y	57	39	9	89	59	Y	121	79	y
26	1A	SUB	^Z	58	3A	:	90	5A	Z	122	7A	z
27	1B	ESC	^[59	3B	;	91	5B	[123	7B	{
28	1C	FS	^\	60	3C	<	92	5C	\	124	7C	
29	1D	GS	^]	61	3D	=	93	5D]	125	7D	}
30	1E	RS	^^	62	3E	>	94	5E	^	126	7E	~
31	1F	US	^_	63	3F	?	95	5F	_	127	7F	D

Appendix F — Glossary of Terms

Aberration — The failure of an optical lens to produce an exact point-to-point correspondence between the object and its resulting image. Various types are chromatic, spherical, coma, astigmatism and distortion.

Absorption — The loss of light of certain wavelengths as it passes through a material and is converted to heat or other forms of energy. (–)

Active Illumination — Lighting an area with a light source coordinated with the acquisition of an image. Strobed flash tubes and pulsed lasers are examples.

Ambient Light — Light which is present in the environment of the imaging front end of a vision system and generated from outside sources. This light, unless used for actual illumination, will be treated as background **Noise** by the vision system.

Analog — A smooth, continuous voltage or current signal or function whose magnitude (value) is the information.

Analog-to-Digital Converter (A/D Converter or ADC) — A device that converts an analog voltage or current signal to a discrete series of digitally encoded numbers (signal) for computer processing.

Application-Specific Integrated Circuit (ASIC) — An integrated circuit that is customized for a particular kind of use, rather than general use. All vision system elements including firmware can be integrated into one ASIC.

Architecture — The hardware organization of a vision system designed for high speed image analysis.

Aspect Ratio — The ratio between the height and width of a sensor or display. Found by dividing the vertical number of pixels (height) by the horizontal number of pixels (width) leaving it in fractional format.

Automatic Gain Control (AGC) — Adjustment to signal strength that seeks to maintain a constant level regardless of the distance between a reader and symbol.

Auxiliary Port — RS-232 connection to an auxiliary terminal or device for remote viewing.

Blooming — A situation in which too many photons are being produced to be received by a pixel. The pixel overflows and causes the photons to go to adjacent pixels. Blooming is similar to overexposure in film photography, except that in digital imaging, the result is a number of vertical and/or horizontal streaks appearing from the light source in the picture.

Baud Rate — The number of discrete signal events per second; bits per second.

Capture — The act of acquiring and storing video images in an imager or host computer. Also, the image captured.

Charge-Coupled Device (CCD) — A semiconductor device with an array of light-sensitive elements that converts light images into electrical signals.

Check Character — A Modulus 43 or Modulus 10 character that is added to encoded symbol data for additional data integrity.

Complementary Metal Oxide Semiconductor (CMOS) — Like CCDs, CMOS imagers include an array of photo-sensitive diodes, one diode within each pixel. Unlike CCDs, however, each pixel in a CMOS imager has its own individual amplifier integrated inside.

Connector — A plug or socket on a device or cable providing in/out connectivity for various circuits and pins.

Concentrator — Intermediary device that relays data from imagers to a host and commands from the host to the imagers or other devices.

Counter — Memory space allocated to keep track of imager events.

Daisy Chain — Linkage of primary and secondary imagers allowing data to be relayed up to the host via auxiliary port connections.

Decode — A **Good Read**. The successful interpretation and output of the information encoded in a symbol.

Default — Restores **ROM** or flash settings, initializes serial commands and resets all counters.

Delimited — A delimited command or field is bracketed by predefined characters.

Decode Rate — The number of good reads per second achieved by an imager.

Dark Field Illumination — Lighting of objects, surfaces, or particles at very shallow or low angles, so that light does not directly enter a reader's optical hardware.

Depth-of-Field — The in-focus range of an imaging system. Measured from the distance behind an object to the distance in front of the object with all objects appearing in focus.

Diffused Lighting — Scattered soft lighting from a wide variety of angles used to eliminate shadows and specular glints from profiled, highly reflective surfaces.

Digital-to-Analog Converter (DAC) — A **VLSI** circuit used to convert digitally processed images to analog for display on a monitor.

Digital Imaging — Conversion of an image into pixels by means of an **Analog-to-Digital Converter** where the level of each pixel can be stored digitally.

Digital Signal Processor (DSP) — A **VLSI** chip designed for ultra-high-speed arithmetic processing. Often imbedded in a vision engine.

Discrete I/O — Inputs and outputs characterized by discrete signal transitions from one voltage level to another so that digital switching can occur.

Direct Memory Access (DMA) — A capability provided by some computer bus architectures that allows data to be sent directly to memory from an attached device.

Dynamic Range — The difference between the minimum and maximum thresholds of discernible images; the amount of usable signal.

Edge Enhancement — Image processing method to strengthen high-spatial frequencies in the image.

Embedded Memory — Onboard memory device such as **EPROM** or flash.

End of Read Cycle — The time or condition at which the imager stops expecting symbol information to decode.

Erasable Programmable Read-Only Memory (EPROM) — A memory chip that retains data when its power supply is turned off; "non-volatile memory".

External Edge — Allows a read cycle to be initiated by a trigger signal from an object detector when it detects the appearance of an object (rising edge). The read cycle ends with a good read, a timeout, or a new trigger.

Glossary of Terms

External Level — Allows a read cycle to be initiated by a trigger signal from an object detector. The read cycle ends when the object moves out of the detector's range.

Falling Edge — A change of state (to inactive) associated with a level trigger.

Field-Programmable Gate Array (FPGA) — A semiconductor device containing programmable interconnects and logic components.

Fill Factor — Percentage of pixel area used for light collection.

Firmware — Software hard-coded in non-volatile memory (**ROM**), and closely tied to specific pieces of hardware.

Fixed Symbol Length — Increases data integrity by ensuring that only one symbol length will be accepted.

Focal Distance — In camera-based vision, the distance from the front of the camera to the object being viewed. (In optics, the distance from the lens to the focal plane.)

Focal Plane — Usually found at the image sensor, it is a plane perpendicular to the lens axis at the point of focus (–).

Focus — Any given point in an image at which light converges; the focal point.

Frame — The total area captured in an image sensor while the video signal is not blanked.

Frame Grabber — A device that interfaces with a camera and, on command, samples the video, converts the sample to a digital value and stores that in a computer's memory.

Front End System — The object, illumination, optics and imager blocks of a vision system. Includes all components useful to acquire a good image for subsequent processing.

Full Duplex — A communications system in which signals can travel simultaneously between devices.

Gain — The amount of energy applied to pixel gray scale values prior to output, expressed in dB; optimal signal strength.

Good Read — A decode. The successful scanning and decoding of the information encoded in a bar code symbol.

Gradient — The rate of change of pixel intensity (first derivative).

Gray Scale — Variations of values from white, through shades of gray, to black in a digitized image with black assigned the value of zero and white the value of one.

Half Duplex — A communications system in which signals can travel between devices in both directions, but not simultaneously.

Histogram — A graphical representation of the frequency of occurrence of each intensity or range of intensities (gray levels) of pixels in an image. The height represents the number of observations occurring in each interval.

Host — A computer, **PLC**, or other device that is used to execute commands and process data and discrete signals.

Image — Projection of an object or scene onto a plane (i.e. screen or image sensor).

Image Processing (IP) — Transformation of an input image into an output image with desired properties.

Image Resolution — The number of rows and columns of pixels in an image. A higher resolution means that more pixels are available per element of the symbol being read. Examples: 640 x 480 (VGA); 854 x 480 (WVGA); 1280 x 1024 (SXGA); 2048 x 1536 (QXGA).

Image Sensor — A device that converts a visual image to an electrical signal; a **CCD** or **CMOS** array.

Initialize — Implement serial configuration commands into the imager's active memory.

Input — A channel or communications line. Decoded data or a discrete signal that is received by a device.

Integration — Exposure of pixels on a **CMOS** sensor.

Ladder Orientation — A linear symbol orientation in which the bars are parallel to the symbol's direction of travel.

Light-Emitting Diode (LED) — A semiconductor device that emits light when conducting current.

Lens — A transparent piece of material with curved surfaces which either converge or diverge light rays.

Machine Vision — The automatic acquisition and analysis of images to obtain desired data for controlling a specific activity.

Multidrop — A communications protocol for networking two or more imagers or other devices with a concentrator (or controller) and characterized by the use of individual device addresses and the RS-485 standard.

Noise — The same as static in a phone line or "snow" in a television picture, noise is any unwanted electrical signal that interferes with the image being read and transferred by the imager.

Normally Closed — A discrete output state that is only active when open.

Normally Open — A discrete output state that is only active when closed.

Object Plane — An imaginary plane in the field of view, focused by an imager's optical system at the corresponding image plane on the sensor.

Output — A channel or communications line. Data or discrete signals that are transmitted or displayed by a device.

Parity — An error detection routine in which one data bit in each character is set to **1** or **0** so that the total number of **1** bits in the data field is even or odd.

Picket Fence Orientation — A linear symbol orientation in which the bars are perpendicular to the symbol's direction of travel.

Pitch — Rotation of a linear or 2D symbol around an axis parallel to the symbol length on the **Substrate**.

Pixel — An individual element in a digitized image array; "picture element".

Port — Logical circuit for data entry and exit. (One or more ports may be included within a single connector.)

Processing Time — The time used by a vision system to receive, analyze and interpret image information. Often expressed in "parts per minute".

Glossary of Terms

Programmable Logic Controller (PLC) — An electronic device used in industrial automation environments such as factory assembly lines and automotive manufacturing facilities.

Progressive Scan — A non-interlaced scan that doubles the number of visible picture lines per field by displaying all picture lines at once.

Protocol — The rules for communication between devices, providing a means to control the orderly flow of information between linked devices.

Random Access Memory (RAM) — A data storage system used in computers, composed of integrated circuits that allow access to stored data in any sequence without movement of physical parts.

Read Cycle — A programmed period of time or condition during which a reader will accept symbol input.

Read-Only Memory (ROM) — A data storage medium used in computers and other electronics, primarily used to distribute **Firmware**.

Real-Time Processing — In machine vision, the ability of a system to perform a complete analysis and take action on one part before the next one arrives for inspection.

Region — Area of an image. Also called a region of interest for image processing operations.

Saturation — The degree to which a color is free of white. One of the three properties of color perception, along with hue and value.

Scattering — Redirection of light reflecting off a surface or through an object.

Skew — Rotation of a linear or 2D symbol around an axis parallel to the symbol height on the substrate.

Substrate — The surface upon which a linear or 2D symbol is printed, stamped, or etched.

Symbol Transitions — The transition of bars and spaces on a symbol, used to detect the presence of a symbol on an object.

Symbology — A symbol type, such as Code 39 or Code 128, with special rules to define the widths and positions of bars and spaces to represent specific numeric or alphanumeric information.

Tilt — Rotation of a linear or 2D symbol around an axis perpendicular to the substrate.

Trigger — A signal, transition, or character string that initiates a read cycle.

Very Large-Scale Integration (VLSI) — The creation of integrated circuits by combining thousands of transistor-based circuits on a single chip.

Watchdog Timer — A security device that detects system crashes and attempts to reset the imager.